



# AQUAPLASTIK MORAVA s.r.o.

Nádražní 1401, 593 01 Bystřice nad Pernštejnem

VELKOOBCHOD PLASTOVÝMI POTRUBNÍMI SYSTÉMY  
AUTOMATICKÉ ZAVLAŽOVACÍ SYSTÉMY  
PŘÍSLUŠENSTVÍ  
NÁŘADÍ



[www.aquaplastik.cz](http://www.aquaplastik.cz)

## CENÍK

platný od 1.3.2024



+GF+



Společnost **AQUAPLASTIK MORAVA s.r.o.** byla založena v roce 2003 jako česká obchodní firma. Hlavní činností firmy je velkoobchod plastovými potrubními systémy a poskytování komplexních služeb v oblasti závlahových systémů. Základní podnikatelskou filozofií je dodávka produktů vysoké kvality v příznivých cenových relacích na českém a slovenském trhu. Prodejní sklad našich výrobků i sídlo firmy je v Bystřici nad Pernštejnem, kde Vás rádi uvítáme.

## Produkty

- 01 komponenty pro závlahy (ovládací jednotky, elektromagnetické ventily, postřikovače, atd.)
- 02 PP-B závitové tvarovky PN10, PP-B vnitřní tvarovky
- 03 PP-B válcové kohouty
- 04 kapkovací trubky a tvarovky, kapkovací pásy a tvarovky
- 05 filtry
- 06 mikrozávlaha
- 07 příslušenství pro zavlažování
- 14 Ms závitové varovky a armatury
- 32 PVC tlakové trubky na lepení, PVC tvarovky na lepení, závitové a přechodové, PVC armatury ruční a s pohonem, PVC filtry, rotametry
- 36 PP-H tlakové trubky, PP-H tvarovky polyfuzní a na tupo, PP-H armatury
- 40 PE tlakové trubky, PE100 elektrotvarovky, PE100 tvarovky na tupo, PP-B svěrné tvarovky, mosazné svěrné tvarovky, PP-B navrtávací objímky
- 43 PP-R tlakové trubky, PP-R tvarovky polyfuzní a přechodové, PP-R armatury
- P příslušenství a nářadí (příchytky, lepidla, maziva, montážní pěny, nářadí, svářečky)
- S solární absorbery AKYSUN

Dále dodáváme i zboží v ceníku neuvedené, zejména:

- průmyslové potrubní systémy z materiálů PVC-U, PVC-C, PP-H, PE, ABS a PVDF zejména značek Comer, Polypipe Italia, Astore, +GF+, FIP a VDL
- veškeré komponenty pro závlahové systémy včetně čerpadel a filtrace

Provádíme zpracování projektové dokumentace závlahového systému s kompletní dodávkou a realizací, včetně záručního i pozáručního servisu

## Snadný nákup v našem internetovém obchodě!

Přinášíme našim zákazníkům možnost on-line nakupovat a sledovat průběh objednávky. Cílem je zefektivnění obchodní komunikace a logistiky.

Zaregistrujte se ještě dnes a využijte výhod moderního nakupování v našem e-shopu.

[www.aquaplastik.cz](http://www.aquaplastik.cz)

## Všeobecné obchodní podmínky:

- Ceny - Ceníkové ceny jsou uvedeny bez DPH. Pravidelně aktualizovaný ceník ve formátu PDF je umístěn na našich webových stránkách. Pro montážní firmy a obchodníky poskytujeme slevy.
- Platební podmínky – Pro stálé zákazníky faktura se splatností 14 dnů ode dne vystavení, pokud není dohodnuto jinak. Noví zákazníci – platba před odběrem zboží, nebo hotově při odběru zboží.
- Dodací podmínky – Zboží máme obvykle skladem a expedujeme ho do 24 hod po obdržení objednávky. Zboží, které není skladem a je skladem u dodavatelů v ČR expedujeme obvykle do 3 dnů. Zboží od zahraničních dodavatelů, které není momentálně skladem, expedujeme do 2-3 týdnů.
- Doprava ČR - Při objednávce (mimo trubek – platí pro tyče i náviny) nad 5 000 Kč doprava po ČR **zdarma**. Při objednávce nad 35 000 Kč doprava po ČR zdarma včetně trubek. Zboží zasíláme přepravní službou TOPTRANS nebo DPD a dopravné účtujeme dle skutečnosti. V případě větší objednávky zajišťujeme vlastní dopravu.
- Doprava Slovensko - Při objednávce (mimo trubek – platí pro tyče i náviny) nad 300 EUR doprava **zdarma**. Doprava trubek řešena individuálně. Zboží zasíláme přepravní službou TOPTRANS nebo DPD.
- Řezání trubek – Vybraný sortiment trubek dodáme i v kratších délkách než výrobních, krátíme PVC-U, PP-R, PE. Minimální délka je 1m a násobky. PE náviny do d40 včetně krátíme po 10m. PE náviny d50 a větší pouze ve výrobních délkách. K ceně se připočítává poplatek za řezání.
- Vyhrazujeme si právo ke změně cen v případě změny cen výrobce, zejména v případě změny cen vstupních surovin nebo v případě výrazné změny kurzu CZK/EUR.

## Potrubi rozvody

---

### **PVC-U systém pro spojování lepením**

použití: pitná voda, odpadní technologická voda, klimatizace, louhy, kyseliny, chemické látky

- rozsah dimenzí: armatury DN10 až DN300, tvarovky a trubky d6 až d500 mm
- tlaková třída systému až PN16, teplotní odolnost 0°C až +50°C, krátkodobě +60°C
- spojování lepením
- PVC-U je stabilizovaný neplastifikovaný polyvinylchlorid

### **PVC-C systém pro spojování lepením**

použití: technologické vody, kyseliny vysokých koncentrací, alkálie, soli, částečně halogeny, skladování a doprava agresivních médií.

- rozsah dimenzí: armatury DN10 až DN300, tvarovky a trubky d16 až d160
- tlaková třída systému až PN16
- teplotní odolnost 0°C až +80°C, krátkodobě až +90°C
- spojování lepením
- PVC-C vzniká dodatečným chlorováním PVC-U. Technické výrobky z PVC mohou obsahovat zbytky monomeru, nepřesahují 0,1 ppm.

### **ABS systém pro spojování lepením**

použití: technologická voda, stlačený vzduch, chlazení, roztoky soli, solanky, suspenze

- rozsah dimenzí: armatury DN10 až DN300, tvarovky a trubky d16 až d315
- tlaková třída metrického systému PN10
- teplotní odolnost -40 až +70°C
- spojování lepením
- jedná se o mimořádně pevný a houževnatý plast s vysokou odolností proti tlakovým rázům, šíření trhlin a odolností proti otěru.  
Dále odolává atmosferickým vlivům. Pyšní se mimořádně nízkou tepelnou vodivostí.
- není vhodný pro koncentrované kyseliny, silné alkálie, organická rozpouštědla, estery, ketony a aromatické uhlovodíky.

### **PE systém pro svařování na tupo, elektrotvarovkami nebo polyfúzně**

použití: pitná voda, technologická voda, plyn, chlazení, chemické látky, odolný hydraulické erozi

- rozsah dimenzí: tvarovky d20 až d1200, trubky d16 až d1200mm
- tlaková třída systému PN10, PN16, lze dodat i pronížší nebo vyšší tlaky, až PN25
- teplotní odolnost -40°C až +60°C
- spojování svařováním na tupo, polyfúzně a elektrotvarovkami
- polyetylen je semikrystalický termoplast ze skupiny polyolefinů a jeho stavební prvky tvoří pouze vodík a uhlík

### **PP-H systém pro svařování polyfúzí a na tupo**

použití: studená a teplá voda, louhy, kyseliny, ředidla, tuky, alkálie

- rozsah dimenzí: armatury DN10 až DN300, tvarovky a trubky d16 až d400mm
- tlaková třída systému až PN10
- teplotní odolnost 0°C až +80°C, krátkodobě až +95°C
- spojování polyfúzním svařováním, na tupo
- polypropylen je termoplast skupiny polyolefinů. Má dobré mechanické vlastnosti, chemickou odolnost a zejména tepelně tvarovou stálost.

### **PP-R systém pro svařování polyfúzí**

použití: studená a teplá voda

- rozsah dimenzí: armatury DN10 až DN90, tvarovky a trubky d16 až d110mm
- tlaková třída systému PN16 a PN20
- teplotní odolnost 0°C až +60°C, krátkodobě +80°C
- spojování polyfúzním svařováním,
- polypropylen je termoplast skupiny polyolefinů. Má dobré mechanické vlastnosti.

### **PVDF systém pro svařování na tupo a polyfúzí**

použití: chlazení, potravinářský průmysl, farmacie, chemické látky

- rozsah dimenzí: armatury DN10 až DN 300, tvarovky a trubky d16 až d225 mm
- tlaková třída systému až PN16
- teplotní odolnost -40 až +140°C
- spojování svařováním na tupo nebo polyfúzním
- polyvinylidenfluorid je vysoce krystalický termoplast s vynikajícími mechanickými, fyzikálními a chemickými vlastnostmi. Vyniká zvláště vysokou krystalitou a tím příznivým průběhem tečení jakož i vysokou termickou stabilitou.

## Ovládací jednotky

01 001



### ovládací jednotky X-Core(i)

Ovládací jednotka pro vnitřní instalaci s možností připojení dálkového ovladače a automatického řízení délky závlahy v závislosti na počasí.

3 nezávislé programy A, B a C, až 12 zavlažovacích cyklů za den, 4 startovací časy denně, doba závlahy 1min. - 4hod. / sekci, intervaly pauzy mezi cykly 1-31dní, kalendář se sedmidenní volbou, sezónní nastavení 10 - 150%, AM / PM nebo 24hod. režim, **nastavitelná pauza mezi sekce**mi, svorky pro hlavní ventil / relé čerpadla, pro senzor deště / větru / teploty, ovládání sekčních + 1 hlavního ventilu, trvalá napěťově nezávislá paměť, indikátor závlahy, indikátor senzoru, senzor BY-PASS, RESET, testovací program, Smart Port pro připojení dálkového ovladače ROAM, 3V záložní zdroj CR2032.

**Integrovaný řídicí modul Solar Sync**, k jednotce stačí připojit multisenzor Solar Sync SEN (není součástí jednotky), ovládací jednotka pak automaticky upravuje délku závlahy podle počasí.

**Ovládací jednotka je dodávána bez napájecího transformátoru, ten je nutné objednat samostatně.**

specifikace	m g	objednávací kód	cena Kč	cena EUR	balení [ks]		sk
					MB	VB	
HUNTER X-Core(i), 2 sekce		01 001 041	1 349,00	56,208			N
HUNTER X-Core(i), 4 sekce		01 001 042	1 699,00	70,792			N
HUNTER X-Core(i), 6 sekcí		01 001 043	1 975,00	82,292			N
HUNTER X-Core(i), 8 sekcí		01 001 044	1 295,00	53,958			N



### ovládací jednotky X-Core

Ovládací jednotka pro vnitřní i venkovní instalaci pod přístřeškem s možností připojení dálkového ovladače a automatického řízení délky závlahy v závislosti na počasí.

3 nezávislé programy A, B a C, až 12 zavlažovacích cyklů za den, 4 startovací časy denně, doba závlahy 1min. - 4hod. / sekci, intervaly pauzy mezi cykly 1-31dní, kalendář se sedmidenní volbou, sezónní nastavení 10 - 150%, AM / PM nebo 24hod. režim, **nastavitelná pauza mezi sekce**mi, svorky pro hlavní ventil / relé čerpadla, pro senzor deště / větru / teploty, ovládání sekčních + 1 hlavního ventilu, trvalá napěťově nezávislá paměť, indikátor závlahy, indikátor senzoru, senzor BY-PASS, RESET, testovací program, Smart Port pro připojení dálkového ovladače ROAM, 3V záložní zdroj CR2032.

**Integrovaný řídicí modul Solar Sync**, k jednotce stačí připojit multisenzor Solar Sync SEN (není součástí jednotky), ovládací jednotka pak automaticky upravuje délku závlahy podle počasí.

**Ovládací jednotka s integrovaným transformátorem.**

specifikace	m g	objednávací kód	cena Kč	cena EUR	balení [ks]		sk
					MB	VB	
HUNTER X-Core, interní trafo, 4 sekce		01 001 031	2 799,00	116,625			N
HUNTER X-Core, interní trafo, 6 sekce		01 001 032	3 285,00	136,875			N
HUNTER X-Core, interní trafo, 8 sekcí		01 001 033	3 999,00	166,625			N



### ovládací jednotky PRO HC, WIFI, HYDRAWISE

Robustní venkovní ovládací jednotka na profesionální úrovni pro využití v rezidenčních a menších komerčních prostorech PHC-601-E s webovým softwarem Hunter Hydrowise. Jednotka nabízí vzdálenou správu závlahového systému, přehledný barevný dotykový displej s podsvícením, intuitivní ovládání a programování pomocí dotykového TFT displeje, PC, nebo mobilního zařízení. Připojení k internetu pouze prostřednictvím WiFi sítě.

specifikace	m g	objednávací kód	cena Kč	cena EUR	balení [ks]		sk
					MB	VB	
HUNTER PRO-HC 601-E, interní trafo, 6 sekcí		01 001 074	7 590,00	316,250			Z
HUNTER PRO-HC 1201-E, interní trafo, 12 sekcí		01 001 075	8 425,00	351,042			Z
HUNTER PRO-HC 2401-E, interní trafo, 24 sekcí		01 001 076	13 980,00	582,500			Z

### externí transformátor 230/24V pro X-Core(i)

specifikace	m g	objednací kód	cena Kč	cena EUR	balení [ks]		sk
					MB	VB	
trafo 230/24V, 25VA, adaptérové provedení do zásuvky		01 001 100	884,50	36,854			N
trafo 230/24V, 25VA, na DIN lištu (3moduly)		01 001 101	---	---			-

### čidlo deště Hunter Rain Klik



2 stupně blokování, pevně nastavená výška srážek 3mm, nastavitelná rychlost vysychání, okamžitá aktivace za 2-5 min pro dočasné blokování, druhý stupeň dlouhodobého blokování po dosažení 3mm srážek

specifikace	m g	objednací kód	cena Kč	cena EUR	balení [ks]		sk
					MB	VB	
čidlo srážek Rain Klik		01 002 001	897,00	37,375			H

### senzorový řídicí systém Solar Sync



Nadřazený řídicí systém, upravující délku závlahy na základě kontinuálně měřené teploty vzduchu a intenzity slunečního záření, ze kterých je vypočtena hodnota denní evapotranspirace. Vhodný pro ovládací jednotky Hunter se Smart Portem (Pro-C). Skládá se z vyhodnocovacího modulu, který je umístěn u ovládací jednotky a senzoru, který je připojen k modulu pomocí kabelu až na vzdálenost 60m (CYKY 1,5 mm<sup>2</sup>). Jednotky X-Core mají vyhodnocovací modul v sobě již integrován, k těmto jednotkám stačí připojit pouze senzor Solar Sync. Součástí senzoru je také čidlo deště Rain Klik.

Výrazná úspora spotřebované vody.

Plně automatický provoz celou sezónu bez nutnosti korekce délky závlahy uživatelem.

specifikace	m g	objednací kód	cena Kč	cena EUR	balení [ks]		sk
					MB	VB	
Solar Sync multisenzor, pro X-Core		01 002 002	2 541,20	105,883			H

## Ventilové šachty

01 060



### ventilová šachta kulatá malá

specifikace	objednací kód	cena Kč	cena EUR	balení [ks]		sk
				MB	VB	
průměr 200/160, výška 230	01 060 001	105,50	4,396			H

Šachta je vhodná pro umístění vodní zásuvky na zahradě.

### ventilová šachta kulatá velká



specifikace	objednací kód	cena Kč	cena EUR	balení [ks]		sk
				MB	VB	
průměr 315/240, výška 250	01 060 002	177,70	7,404			H

Šachta je vhodná pro umístění jednoho sekčního elektomagnetického ventilu na zahradách.

### ventilová šachta obdélníková STANDARD



specifikace	objednací kód	cena Kč	cena EUR	balení [ks]		sk
				MB	VB	
380 x 510/260 x 510/260 x 300	01 060 003	446,00	18,583			H

Šachta je vhodná pro umístění sekčních elektomagnetických ventilů, až pro 3 ks EV 1".

### ventilová šachta obdélníková JUMBO



specifikace	objednací kód	cena Kč	cena EUR	balení [ks]		sk
				MB	VB	
500 x 640/350 x 500, výška 300	01 060 004	778,50	32,438			F

Šachta je vhodná pro umístění sekčních elektomagnetických ventilů, až pro 5 ks EV 1".

### PP kruhová šachta GARD-RAIN



specifikace	objednací kód	cena Kč	cena EUR	balení [ks]		sk
				MB	VB	
průměr 21 cm	01 060 006	404,00	16,833			H

Šachta je vhodná pro připojení zahradní hadice, 3/4" mosazný kulový kohout

## Rozprašovací postřikovače

01 070

### výsuvný postřikovač Hunter PRO-SPRAY 1/2" zátěžový



Výška výsuvu 10, 15 a 30cm. S proplachovou zátčkou, bez trysky. Extra zesílené ABS pouzdro s velmi vysokou odolností proti zatížení, zesílená pružina. Možnost doplnění o zpětný ventil ADV proti vytékání vody z nejnižšího postřikovače (do 3m převýšení). Doporučený pracovní tlak 1 - 5bar., 1/2" vnitřní závit.  
 PRS30 - vestavěný regulátor tlaku na 2,1bar, hnědá hlava  
 RPS40 - vestavěný regulátor tlaku na 2,8bar, zpětný ventil ADV, šedá hlava

specifikace	PN bar	m g	objednací kód	cena Kč	cena EUR	balení [ks]		sk
						MB	VB	
PRO-SPRAY 10cm	6,9		01 070 001	61,00	2,542			H
PRO-SPRAY 15cm	6,9		01 070 002	225,00	9,375			F
PRO-SPRAY 30cm	6,9		01 070 003	363,00	15,125			F
PRO-SPRAY PRS30 10cm	6,9		01 070 021	193,00	8,042			F
PRO-SPRAY PRS40 10cm, ADV ventil	6,9		01 070 031	251,00	10,458			F
zpětný ventil ADV			01 070 040	29,50	1,229			F

01 071

### trysky MP ROTATOR



Rotační trysky MP ROTATOR jsou určeny pro postřikovače PRO-SPRAY a PRS40. Postřikovače s rotační tryskou je možné v jedné sekci kombinovat s rotačními a nikoliv rozprašovacími postřikovači. Průtok vody je cca 1/3 průtoku trysky rozprašovacího postřikovače se stejným dostřikem. Trysky MP ROTATOR mají vnitřní závit a vestavěný pojistný filtr. Doporučený pracovní tlak 2,8bar. Dostřik lze regulovat až o 25%.

barva trysky	specifikace	PN bar	m g	objednací kód	cena Kč	cena EUR	balení [ks]		sk
							MB	VB	
	MP 800 SR								
oranžová	výseč 90° - 210°			01 071 051	219,00	9,125	10		F
zelená	celokružová 360°			01 071 053	219,00	9,125	10		F
	MP CORNER								
tyrkysová	výseč 45° - 105°			01 071 001	219,00	9,125	10		F
	MP 1000								
tmavě červená	výseč 90° - 210°			01 071 002	219,00	9,125	10		F
světle modrá	výseč 210° - 270°			01 071 003	219,00	9,125	10		F
olivová	celokružová 360°			01 071 004	219,00	9,125	10		F
	MP 2000								
černá	výseč 90° - 210°			01 071 011	219,00	9,125	10		F
zelená	výseč 210° - 270°			01 071 012	219,00	9,125	10		F
červená	celokružová 360°			01 071 013	219,00	9,125	10		F
	MP 3000								
modrá	výseč 90° - 210°			01 071 021	219,00	9,125	10		F
žlutá	výseč 210° - 270°			01 071 022	219,00	9,125	10		F
šedá	celokružová 360°			01 071 023	219,00	9,125	10		F
	MP3500								
světle hnědá	výseč 90° - 210°			01 071 031	219,00	9,125	10		F
	MP STRIP								
slonová kost	levý kraj 1,5 x 4,6 m			01 071 041	219,00	9,125	10		F
měděná	pravý kraj 1,5 x 4,6 m			01 071 042	219,00	9,125	10		F
hnědá	pruh 1,5 x 9 m			01 071 043	219,00	9,125	10		F





25 005



### montážní multifunkční klíč pro rotační hlavice MP ROTATOR





specifikace	objednací kód	cena Kč	cena EUR	balení [ks]		sk
				MB	VB	
montážní multifunkční klíč	25 005 001	39,90	1,663			N

# Rozprašovací postřikovače

úhel	tlak bar	MP800SR				MP1000				MP2000				MP3000				MP3500			
		dostřik m	průtok l/min	srážky mm/hod		dostřik m	průtok l/min	srážky mm/hod		dostřik m	průtok l/min	srážky mm/hod		dostřik m	průtok l/min	srážky mm/hod		dostřik m	průtok l/min	srážky mm/hod	
90° 	1,7	-	-	-	-	-	-	-	-	5,2	1,18	11	12	7,6	2,63	11	13	10,1	3,94	9	11
	2,0	2,6	0,64	23	27	3,7	0,61	11	12	5,5	1,23	10	11	8,2	2,77	10	11	10,4	4,28	10	11
	2,5	2,9	0,78	23	26	4,0	0,68	10	12	5,8	1,43	10	12	8,5	3,08	10	12	10,4	4,58	10	12
	<b>2,8</b>	<b>3,1</b>	<b>0,87</b>	<b>21</b>	<b>24</b>	<b>4,1</b>	<b>0,70</b>	<b>10</b>	<b>11</b>	<b>6,1</b>	<b>1,52</b>	<b>10</b>	<b>11</b>	<b>9,1</b>	<b>3,25</b>	<b>9</b>	<b>11</b>	<b>10,7</b>	<b>4,84</b>	<b>10</b>	<b>12</b>
	3,0	3,4	0,95	20	23	4,3	0,73	10	11	6,4	1,57	9	11	9,1	3,38	10	11	10,7	5,22	11	13
	3,5	3,5	1,02	20	23	4,4	0,78	10	11	6,7	1,68	9	10	9,1	3,67	11	12	10,7	5,41	11	13
	3,8	3,5	1,06	20	23	4,6	0,81	9	11	6,7	1,77	9	11	9,1	3,80	11	13	10,7	5,68	12	14
180° 	1,7	-	-	-	-	-	-	-	-	4,9	2,22	11	12	7,6	5,48	11	13	10,1	8,36	10	11
	2,0	2,6	1,25	22	26	3,7	1,20	11	12	5,2	2,35	11	13	8,2	5,88	10	12	10,4	8,48	9	11
	2,5	2,8	1,44	22	25	4,0	1,35	10	12	5,5	2,67	11	12	8,5	6,55	11	12	10,4	10,03	11	13
	<b>2,8</b>	<b>3,0</b>	<b>1,59</b>	<b>21</b>	<b>24</b>	<b>4,1</b>	<b>1,40</b>	<b>10</b>	<b>11</b>	<b>5,8</b>	<b>2,80</b>	<b>10</b>	<b>12</b>	<b>9,1</b>	<b>6,88</b>	<b>10</b>	<b>11</b>	<b>10,7</b>	<b>10,83</b>	<b>11</b>	<b>13</b>
	3,0	3,3	1,74	19	22	4,3	1,46	10	11	6,1	2,90	10	11	9,1	7,18	10	12	10,7	11,73	12	14
	3,5	3,4	1,82	19	22	4,4	1,56	10	11	6,4	3,15	9	10	9,1	7,77	11	13	10,7	12,15	13	15
	3,8	3,5	1,89	18	21	4,6	1,62	9	11	6,4	3,22	9	11	9,1	8,02	12	13	10,7	12,41	13	15
210° 	1,7	-	-	-	-	-	-	-	-	4,9	2,58	11	12	7,6	6,40	11	13	10,1	9,80	10	12
	2,0	2,6	1,44	22	26	3,7	1,41	11	13	5,2	2,75	11	13	8,2	6,85	10	12	10,4	10,75	10	12
	2,5	2,8	1,67	22	25	4,0	1,58	10	12	5,5	3,08	10	12	8,5	7,65	11	12	10,4	11,66	11	13
	<b>2,8</b>	<b>3,0</b>	<b>1,85</b>	<b>21</b>	<b>24</b>	<b>4,1</b>	<b>1,63</b>	<b>10</b>	<b>11</b>	<b>5,8</b>	<b>3,25</b>	<b>10</b>	<b>12</b>	<b>9,1</b>	<b>8,02</b>	<b>10</b>	<b>11</b>	<b>10,7</b>	<b>12,45</b>	<b>11</b>	<b>13</b>
	3,0	3,2	2,01	20	23	4,3	1,71	10	11	6,1	3,42	10	11	9,1	8,37	10	12	10,7	13,40	12	14
	3,5	3,4	2,12	19	22	4,4	1,82	10	11	6,4	3,70	9	10	9,1	9,03	11	13	10,7	14,23	13	15
	3,8	3,5	2,20	18	21	4,6	1,89	9	11	6,4	3,80	10	11	9,1	9,37	12	13	10,7	14,91	13	16
270° 	1,7	-	-	-	-	-	-	-	-	4,9	3,32	11	12	7,6	8,35	12	13				
	2,0					3,7	1,80	11	13	5,2	3,53	11	13	8,2	8,83	10	12				
	2,5					4,0	2,05	10	12	5,5	3,97	10	12	8,5	9,82	11	12				
	<b>2,8</b>					<b>4,1</b>	<b>2,10</b>	<b>10</b>	<b>11</b>	<b>5,8</b>	<b>4,15</b>	<b>10</b>	<b>12</b>	<b>9,1</b>	<b>10,32</b>	<b>10</b>	<b>11</b>				
	3,0					4,3	2,20	10	11	6,1	4,35	10	11	9,1	10,77	10	12				
	3,5					4,4	2,35	10	11	6,4	4,70	9	10	9,1	11,68	11	13				
	3,8					4,6	2,45	9	11	6,4	4,88	9	11	9,1	12,12	12	13				
360° 	1,7	-	-	-	-	-	-	-	-	4,9	4,42	11	12	7,6	10,98	11	13				
	2,0	2,6	2,50	23	26	3,5	2,40	12	14	5,2	4,72	11	13	8,2	11,72	10	12				
	2,5	2,8	2,69	20	23	4,0	2,69	10	12	5,5	5,28	10	12	8,5	13,10	11	12				
	<b>2,8</b>	<b>3,0</b>	<b>2,95</b>	<b>20</b>	<b>23</b>	<b>4,1</b>	<b>2,81</b>	<b>10</b>	<b>12</b>	<b>5,8</b>	<b>5,55</b>	<b>10</b>	<b>12</b>	<b>9,1</b>	<b>13,75</b>	<b>10</b>	<b>11</b>				
	3,0	3,1	3,22	20	23	4,3	2,94	10	11	6,1	5,80	10	11	9,1	14,37	10	12				
	3,5	3,3	3,33	19	21	4,4	3,17	10	11	6,4	6,25	9	10	9,1	15,52	11	13				
	3,8	3,5	3,71	18	21	4,5	3,25	10	11	6,4	6,40	9	10	9,1	16,07	12	13				

úhel	tlak bar	MP corner	
		dostřik m	průtok l/min
45° 	1,7	-	-
	2,0	3,5	0,61
	2,5	4,0	0,68
	<b>2,8</b>	<b>4,1</b>	<b>0,70</b>
	3,0	4,3	0,73
	3,5	4,4	0,78
	3,8	4,5	0,81
90° 	1,7	3,2	1,15
	2,0	3,5	1,27
	2,5	4,0	1,40
	<b>2,8</b>	<b>4,1</b>	<b>1,44</b>
	3,0	4,3	1,57
	3,5	4,4	1,67
	3,8	4,5	1,73
105° 	1,7	3,2	1,34
	2,0	3,5	1,48
	2,5	4,0	1,63
	<b>2,8</b>	<b>4,1</b>	<b>1,70</b>
	3,0	4,3	1,83
	3,5	4,4	1,94
	3,8	4,5	2,00

	tlak bar	dostřik m	průtok l/min
MP pruh levý roh (MP left corner strip) 	1,7	1,1 x 4,2	0,67
	2,0	1,2 x 4,3	0,72
	2,5	1,4 x 4,5	0,79
	<b>2,8</b>	<b>1,5 x 4,6</b>	<b>0,84</b>
	3,0	1,6 x 4,7	0,87
	3,5	1,7 x 4,8	0,94
	3,8	1,8 x 4,9	0,99
MP pruh pravý roh (MP right corner strip) 	1,7	1,1 x 4,2	0,67
	2,0	1,2 x 4,3	0,72
	2,5	1,4 x 4,5	0,79
	<b>2,8</b>	<b>1,5 x 4,6</b>	<b>0,84</b>
	3,0	1,6 x 4,7	0,87
	3,5	1,7 x 4,8	0,94
	3,8	1,8 x 4,9	0,99
MP pruh (MP side strip) 	1,7	1,1 x 8,3	1,34
	2,0	1,2 x 8,6	1,43
	2,5	1,4 x 8,9	1,57
	<b>2,8</b>	<b>1,5 x 9,1</b>	<b>1,66</b>
	3,0	1,6 x 9,3	1,72
	3,5	1,7 x 9,6	1,87
	3,8	1,8 x 9,9	1,96



## Elektromagnetické ventily RAIN

01 020

### elektromagnetický ventil RN150 24V/AC NC



G inch	PN bar	m g	objednáací kód	cena Kč	cena EUR	balení [ks]		sk
						MB	VB	
1/2" vnitřní, regulace průtoku	12		01 020 021	408,00	17,000			F
3/4" vnější, regulace průtoku	12		01 020 023	439,00	18,292			F

RN 150

Solenoid: 24 V/AC (24/DC, 12V/DC, 9V/DC-L)

Solenoid certifikát CE

Krytí cívky: IP68

Každý kus testován při 14 bar

Provozní tlak: 1,0 - 12,0 bar

Provozní teplota +4°C - +70°C

Rozměry:

délka: 95 mm

šířka: 70 mm

výška: 105 mm

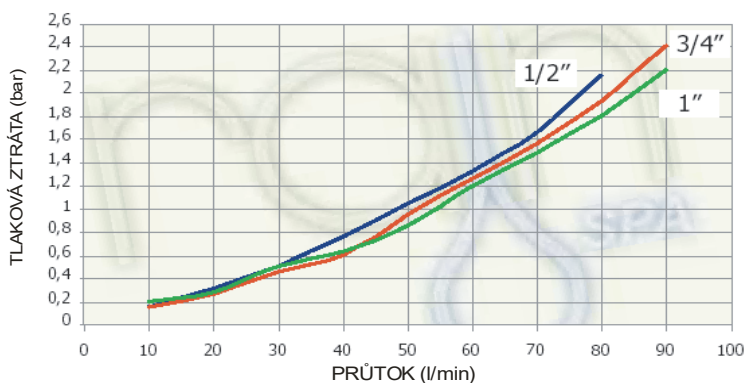

### elektromagnetický ventil RN155 PLUS 24V/AC NC



G inch	PN bar	m g	objednáací kód	cena Kč	cena EUR	balení [ks]		sk
						MB	VB	
1" vnější, regulace průtoku	12		01 020 031	458,00	19,083			F
1" vnitřní, regulace průtoku	12		01 020 032	644,00	26,833			H

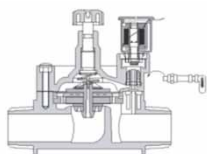

## Elektromagnetické ventily RAIN

01 020

**elektromagnetický ventil RN155 PLUS** vnější závit x převlečná matice



G inch	PN bar	m g	objednáací kód	cena Kč	cena EUR	balení [ks]		sk
						MB	VB	
1" regulace průtoku, 24V/AC	12		01 020 033	484,00	20,167			F
1" regulace průtoku, 9V/DC-L	12		01 020 039	780,00	32,500			H

Solenoid: 24 V/AC (24/DC, 12V/DC, 9V/DC-L)  
 Solenoid certifikát CE  
 Krytí cívky: IP68  
 Každý kus testován při 14 bar  
 Provozní tlak: 1,0 - 12,0 bar  
 Provozní teplota +4°C - +70°C  
 funkce: NC

Rozměry:  
 délka: 92 mm  
 šířka: 73 mm  
 výška: 115 mm

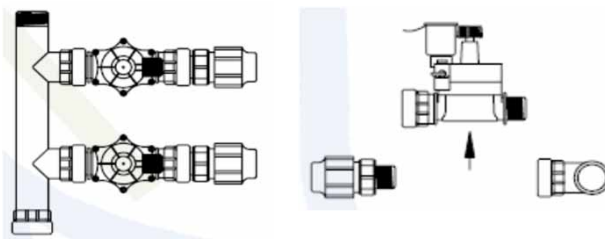
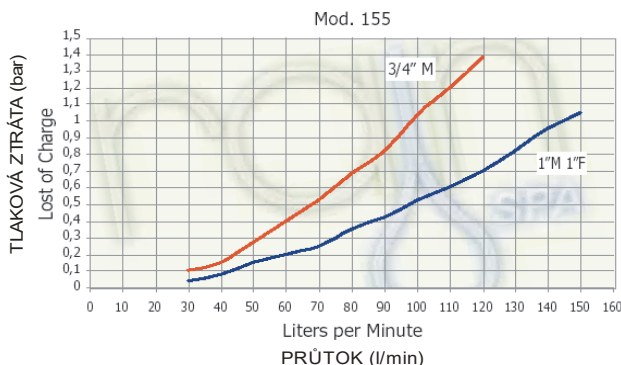

Nová řada elektromagnetických ventilů RN 155 je výsledkem studie, která spojuje rychlost instalace s jednoduchostí používání a vysokými výkonnostními parametry. Vnější závit činí tento ventil zvláště vhodným pro použití u předsmontovaných sestav (PVC rozdělovače 0300) nebo u PVC tvarovek s převlečnou maticí a O-kroužkem, díky rychlosti montáže takového ventilu. Malá páčka na horní straně tělesa ventilu umožňuje manuální otevření ventilu a to i pro nespécializovaný personál, tedy koncového uživatele.

Ventil je velmi pevný, poněvadž všechny díly jsou vyrobeny z prvotřídního plastu (polyamid s 30% skleněných vláken) a zaručují mechanickou odolnost a pružnost tělesa při vysokých tlacích. Ventil má také pozoruhodnou pevnost závitů a to i při instalaci v zimním období. Větší vnitřní otvory umožňují provoz ventilu i s ne perfektně čistou vodou. Proto nerezová tyčka (AISI 304) usnadňuje čištění membrány při každém pracovním cyklu. Vnitřní průtočný průměr 1" umožňuje průtok až 150l/min. Nové elektromagnety PN 12 a zesílené provedení tělesa zajišťují dokonalý provoz při vysokých tlacích. Elektromagnetické ventily jsou dodávány s nebo bez možnosti řízení průtoku.

01 022

**elektromagnetický ventil 730 24V/DC** vnitřní závit, regulace průtoku NC



G inch	PN bar	m g	objednáací kód	cena Kč	cena EUR	balení [ks]		sk
						MB	VB	
1"	10		01 022 011	835,20	33,408			E

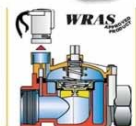

Solenoid: 24 V/DC  
 Krytí cívky: IP55  
 Provozní tlak: 0,5 - 10bar

Rozměry:  
 délka: 128 mm  
 šířka: 90 mm  
 výška: 128 mm

## Elektromagnetické ventily RAIN

01 020

### elektromagnetický ventil RN160 PLUS s vnitřními závity, 24V/AC NC



G inch	PN bar	m g	objednací kód	cena Kč	cena EUR	balení [ks]		sk
						MB	VB	
1 1/4" - regulace průtoku	12		01 020 051	996,00	41,500			F
1 1/2" - regulace průtoku	12		01 020 052	1 215,00	50,625			F
2" - regulace průtoku	12		01 020 054	1 640,00	68,333			F

### elektromagnetický ventil RN160 PLUS vnější závit x převlečná matice, 24V/AC

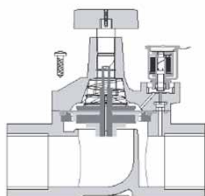

G inch	PN bar	m g	objednací kód	cena Kč	cena EUR	balení [ks]		sk
						MB	VB	
1 1/2" regulace průtoku	12		01 020 053	1 320,00	55,000			H
2" regulace průtoku	12		01 020 055	1 694,00	70,583			H

Solenoid: 24 V/AC (24/DC, 12V/DC, 9V/DC-L)  
 Certifikát CE  
 Krytí cívky: IP68  
 Každý kus testován při 14 bar  
 Provozní tlak: 1,0 - 12 bar  
 Provozní teplota +4°C - +70°C  
 funkce: NC

Rozměry:  
 délka: 132 mm  
 šířka: 77 mm  
 výška: 115 mm

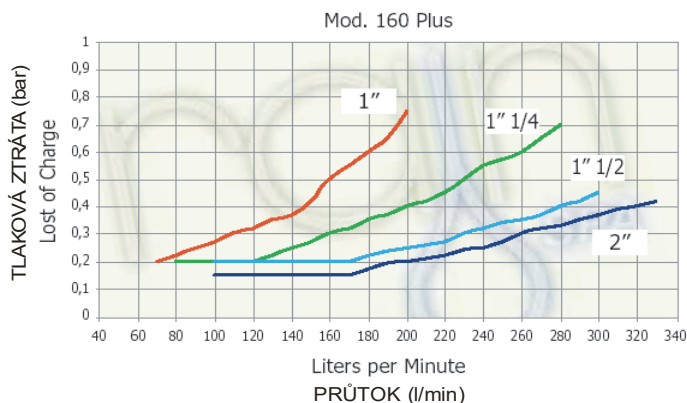

### Instalace a vyjmutí elektromagnetického ventilu s převlečnou maticí

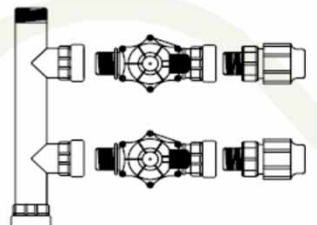

Elektromagnetické ventily série 160 plus jsou určeny pro profesionální aplikace a představují optimální alternativu k bronzovým ventilům. Ventil je výsledkem dlouhodobého výzkumu v dynamice kapalin. Interní průtok vody v systému odpovídá průměru 2", takže ventily s průměrem 1" a 1 1/2" představují optimální prvky.

Tento nový elektromagnet, který se objevil jako "vedlejší produkt" projektu PN 12, zajišťuje dokonalou funkci u aplikací s vysokým statickým i pracovním tlakem. Nový, vylehčený píst ventilu usnadňuje jeho ovládání při nízkém napětí (což je velmi užitečná vlastnost tam, kde dodavatel systému nesprávně dimenzuje průřezy elektrických vodičů).

Pevnost je zaručena výběrem surovin na výrobu konstrukčních částí a všech interních dílů. Použitý plastový materiál je tvořen polyamidem 3, s přidávkou 30% skleněných vláken. Zajišťuje pružnost u závitů a pevnost při mechanickém namáhání.

Tvrzená pryž použitá na membrány, podobně jako kovové díly (podle AISI 304 a IMRE 430) zajišťuje dlouhou životnost výrobku. Pro snížení doby na údržbu a údržbových nákladů pro dodavatele mají ventily Rain velké vnitřní otvory a při zavíracím/otvíracím cyklu dochází k samočištění membrány.

Pružina kotvy (pístu) přitlačuje píst k elektromagnetu, takže žádný z dílů se nemůže ztratit. Zvláště zajímavý je model velikosti 2", který představuje optimální řešení z hlediska jakosti a ceny pro náročné a velké aplikace.

## Elektromagnetické ventily RAIN

01 020



**elektromagnetický ventil RN180 IBN s vnitřními závity, 24V/AC**

G inch	PN bar	m g	objednací kód	cena Kč	cena EUR	balení [ks]		sk
						MB	VB	
2" - regulace průtoku	12		01 020 060	2 373,00	98,875			H
3" - regulace průtoku	12		01 020 061	3 638,00	151,583			H

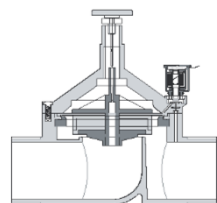

**elektromagnetický ventil RN180 IBN s vnějšími závity**

G inch	PN bar	m g	objednací kód	cena Kč	cena EUR	balení [ks]		sk
						MB	VB	
3" - regulace průtoku	12		01 020 062	3 220,00	134,167			F

Solenoid: 24 V/AC (24/DC, 12V/DC, 9V/DC-L)

Certifikát CE

Krytí cívky: IP68

Každý kus testován při 14 bar

Provozní tlak: 1,0 - 12 bar

Provozní teplota +4°C - +70°C

funkce: NC

Rozměry:

délka: 240 mm

šířka: 170 mm

výška: 270 mm

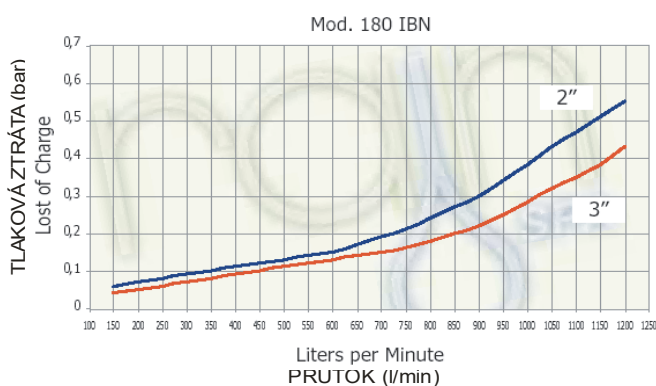

Elektroventil RN 180 IBN byl navržen pro aplikace v zemědělství a představuje optimální alternativu na sportovištích nebo v prostorách s veřejnou zelení. Návrh ventilu je výsledkem studie na zvýšení pevnosti závitů, které musí snést i nejhorsí namáhání způsobené fitinkami. Použitý materiál (polyamid 6) je pružným materiálem, který snáší nízké teploty při instalaci. Materiál je také vyztužený skleněnými vlákny, které mu dávají vynikající mechanickou odolnost. Všechny interní otvory jsou jedny z největších u elektroventilů na trhu a umožňují průtok i ne zrovna čisté vody. Každý otvor v membránové sestavě se dá čistit ocelovou tyčinkou podle AISI 304. Také pro zavlažování se uvažuje se speciální membránou, s uzávěrkou a O-kroužkem z Tecnofluonu. Interní průchozí otvor velikosti 3" představuje skutečně velký průměr z hlediska tlakové ztráty. Také manuální vypouštění se tím dá jednoduše provádět, aniž by bylo nutné zaplavovat ventilovou skříň. Zavírací fáze je pomalá, aby se zabránilo nebezpečným dynamickým hydraulickým rázům na tvarovky a potrubí.

## Ovládací cívky pro elektromagnetické ventily

01 020



**cívka**

	PN bar	m g	objednací kód	cena Kč	cena EUR	balení [ks]		sk
						MB	VB	
24V/AC			01 020 096	344,00	14,333			F
24V/DC			01 020 094	516,70	21,529			E
12V/AC			01 020 092	516,70	21,529			E
12V/DC			01 020 093	516,70	21,529			E



**cívka 9V/DC-L**

	PN bar	m g	objednací kód	cena Kč	cena EUR	balení [ks]		sk
						MB	VB	
9V/DC-L			01 020 095	519,00	21,625			F

## Polypropylenové závitové tvarovky

02 085



vsuvka

R	PN bar	m g	objednáací kód	cena Kč	cena EUR	balení [ks]		sk
						MB	VB	
1/2"	10		02 085 012	6,40	0,256	100	1200	R
3/4"	10		02 085 034	7,70	0,308	100	600	R
1"	10		02 085 100	11,40	0,456	50	400	R
1 1/4"	10		02 085 114	19,80	0,792	50	200	R
1 1/2"	10		02 085 112	26,60	1,064	30	150	R
2"	10		02 085 200	41,30	1,652	10	80	R
2 1/2"	10		02 085 212	70,00	2,800	10	50	R

02 086



vsuvka redukována

R x R	PN bar	m g	objednáací kód	cena Kč	cena EUR	balení [ks]		sk
						MB	VB	
3/4" x 1/2"	10		02 086 034 012	7,70	0,308	100	800	R
1" x 1/2"	10		02 086 100 012	8,70	0,348	50	500	R
1" x 3/4"	10		02 086 100 034	11,40	0,456	50	400	R
1 1/4" x 1/2"	10		02 086 114 012	15,60	0,624			R
1 1/4" x 3/4"	10		02 086 114 034	14,80	0,592	50	250	R
1 1/4" x 1"	10		02 086 114 100	17,10	0,684	50	250	R
1 1/2" x 1/2"	10		02 086 112 012	24,20	0,968			R
1 1/2" x 3/4"	10		02 086 112 034	24,20	0,968			R
1 1/2" x 1"	10		02 086 112 100	25,40	1,016	20	200	R
1 1/2" x 1 1/4"	10		02 086 112 114	27,20	1,088	30	150	R
2" x 1/2"	10		02 086 200 012	36,20	1,448			R
2" x 3/4"	10		02 086 200 034	36,20	1,448			R
2" x 1"	10		02 086 200 100	52,60	2,104	10	150	C
2" x 1 1/4"	10		02 086 200 114	42,60	1,704	20	100	R
2" x 1 1/2"	10		02 086 200 112	42,60	1,704	20	100	R
2 1/2" x 2"	10		02 086 212 200	119,50	4,780	10	50	R

02 070



spojka

Rp	PN bar	m g	objednáací kód	cena Kč	cena EUR	balení [ks]		sk
						MB	VB	
1/2"	10		02 070 012	14,90	0,596	50	650	R
3/4"	10		02 070 034	15,80	0,632	50	400	R
1"	10		02 070 100	21,60	0,864	50	250	R
1 1/4"	10		02 070 114	51,40	2,056	20	160	R
1 1/2"	10		02 070 112	66,10	2,644	20	100	R
2"	10		02 070 200	87,10	3,484	10	60	R

02 071



spojka redukována

Rp x Rp	PN bar	m g	objednáací kód	cena Kč	cena EUR	balení [ks]		sk
						MB	VB	
3/4" x 1/2"	10		02 071 034 012	16,50	0,660	50	450	R
1" x 1/2"	10		02 071 100 012	17,00	0,680	50	300	R
1" x 3/4"	10		02 071 100 034	21,50	0,860	50	300	R
1 1/4" x 1"	10		02 071 114 100	46,00	1,840	50	150	R
1 1/2" x 1"	10		02 071 112 100	75,60	3,024	20	120	R
1 1/2" x 1 1/4"	10		02 071 112 114	70,10	2,804	20	100	R
2" x 1"	10		02 071 200 100	107,50	4,300	10	100	R
2" x 1 1/4"	10		02 071 200 114	121,40	4,856	10	80	R
2" x 1 1/2"	10		02 071 200 112	82,70	3,308	10	70	R

## Polypropylenové závitové tvarovky

02 073



spojka závitová redukováaná vnější x vnitřní závit

R x Rp	PN bar	m g	objednáací kód	cena Kč	cena EUR	balení [ks]		sk
						MB	VB	
1/2" x 3/4"	10		02 073 012 034	26,70	1,068	50	550	R
1/2" x 1"	10		02 073 012 100	30,80	1,232	50	400	R
3/4" x 1"	10		02 073 034 100	36,40	1,456	50	350	R

02 074



spojka závitová redukováaná vnější x vnitřní závit

Rp x R	PN bar	m g	objednáací kód	cena Kč	cena EUR	balení [ks]		sk
						MB	VB	
1/2" x 1/4"	10		02 074 012 014	68,90	2,756	50	1200	D
3/4" x 1/4"	10		02 074 034 014	22,80	0,912	50	700	R
3/4" x 1/2"	10		02 074 034 012	19,10	0,764	50	600	R
1" x 1/2"	10		02 074 100 012	21,80	0,872	50	400	R
1" x 3/4"	10		02 074 100 034	21,80	0,872	50	400	R

02 080



víčko

Rp	PN bar	m g	objednáací kód	cena Kč	cena EUR	balení [ks]		sk
						MB	VB	
1/2"	10		02 080 012	5,60	0,224	100	1800	R
3/4"	10		02 080 034	8,10	0,324	100	1000	R
1"	10		02 080 100	9,70	0,388	100	600	R
1 1/4"	10		02 080 114	16,40	0,656	50	300	R
1 1/2"	10		02 080 112	27,30	1,092	30	210	R
2"	10		02 080 200	35,40	1,416	20	120	R

02 081



zátká

R	PN bar	m g	objednáací kód	cena Kč	cena EUR	balení [ks]		sk
						MB	VB	
1/2"	10		02 081 012	7,40	0,296	100	1800	R
3/4"	10		02 081 034	10,60	0,424	100	1000	R
1"	10		02 081 100	10,60	0,424	100	600	R
1 1/4"	10		02 081 114	17,60	0,704	50	300	R
1 1/2"	10		02 081 112	27,60	1,104	30	210	R
2"	10		02 081 200	38,20	1,528	20	120	R
2 1/2"	10		02 081 212	61,50	2,460	10	80	R
3"	10		02 081 300	131,40	5,256		50	R
4"	10		02 081 400	257,60	10,304		54	R

02 097



redukce

R x Rp	PN bar	m g	objednáací kód	cena Kč	cena EUR	balení [ks]		sk
						MB	VB	
3/4" x 1/2"	10		02 097 034 012	14,90	0,596	100	1100	R
1" x 1/2"	10		02 097 100 012	15,80	0,632	50	600	R
1" x 3/4"	10		02 097 100 034	16,20	0,648	50	600	R
1 1/4" x 1/2"	10		02 097 114 012	23,30	0,932	50	350	R
1 1/4" x 3/4"	10		02 097 114 034	23,30	0,932	50	350	R
1 1/4" x 1"	10		02 097 114 100	27,20	1,088	50	350	R
1 1/2" x 3/4"	10		02 097 112 034	30,70	1,228	50	250	R
1 1/2" x 1"	10		02 097 112 100	33,90	1,356	50	250	R
1 1/2" x 1 1/4"	10		02 097 112 114	33,90	1,356	50	250	R
2" x 1"	10		02 097 200 100	66,60	2,664	20	140	R
2" x 1 1/4"	10		02 097 200 114	57,20	2,288	20	140	R
2" x 1 1/2"	10		02 097 200 112	77,60	3,104	20	140	R
2 1/2" x 2"	10		02 097 212 200	126,90	5,076	10	80	R
3" x 2"	10		02 097 300 200	194,60	7,784		60	R
3" x 2 1/2"	10		02 097 300 212	194,60	7,784		60	R

## Polypropylenové závitové tvarovky

02 003



koleno 90°

Rp	PN bar	m g	objednáací kód	cena Kč	cena EUR	balení [ks]		sk
						MB	VB	
1/2"	10		02 003 012	23,50	0,940	50	500	R
3/4"	10		02 003 034	37,00	1,100	50	300	R
1"	10		02 003 100	41,30	1,652	50	150	R
1 1/4"	10		02 003 114	62,20	2,488	20	100	R
1 1/2"	10		02 003 112	110,30	4,412	10	60	R
2"	10		02 003 200	156,80	6,272	10	40	R
2 1/2"	10		02 003 212	332,80	13,312		22	R

02 004



koleno 90° vnější x vnitřní závit

R x Rp	PN bar	m g	objednáací kód	cena Kč	cena EUR	balení [ks]		sk
						MB	VB	
1/2"	10		02 004 012	25,50	1,020	100	600	R
3/4"	10		02 004 034	30,70	1,228	50	350	R
1"	10		02 004 100	38,40	1,536	25	175	R
1 1/4"	10		02 004 114	62,40	2,496	20	100	R

02 005



koleno 90°

R	PN bar	m g	objednáací kód	cena Kč	cena EUR	balení [ks]		sk
						MB	VB	
1/2"	10		02 005 012	20,80	0,832	100	800	R
3/4"	10		02 005 034	25,70	1,028	50	450	R
1"	10		02 005 100	29,50	1,180	50	250	R
1 1/4"	10		02 005 114	59,50	2,380	50	150	R

02 043



T -kus 90°

Rp	PN bar	m g	objednáací kód	cena Kč	cena EUR	balení [ks]		sk
						MB	VB	
1/2"	10		02 043 012	37,10	1,484	50	350	R
3/4"	10		02 043 034	50,90	2,036	50	200	R
1"	10		02 043 100	55,00	2,200	20	120	R
1 1/4"	10		02 043 114	95,30	3,812	10	60	R
1 1/2"	10		02 043 112	143,90	5,756	10	40	R
2"	10		02 043 200	206,20	8,248		30	R

02 044

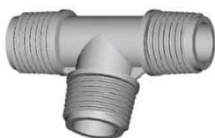

T -kus 90° vnější závit

R	PN bar	m g	objednáací kód	cena Kč	cena EUR	balení [ks]		sk
						MB	VB	
1/2"	10		02 044 012	17,80	0,712	100	500	R
3/4"	10		02 044 034	20,20	0,808	50	300	R
1"	10		02 044 100	29,70	1,188	30	150	R
1 1/4"	10		02 044 114	42,60	1,704	20	80	R

02 048

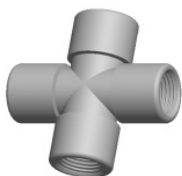

kříž

Rp	PN bar	m g	objednáací kód	cena Kč	cena EUR	balení [ks]		sk
						MB	VB	
1/2"	10		02 048 012	56,60	2,358	30	600	R
3/4"	10		02 048 034	78,70	3,279	20	320	R
1"	10		02 048 100	209,70	8,738	10	180	R
1 1/4"	10		02 048 114	251,90	10,496	10	100	R
1 1/2"	10		02 048 112	760,80	31,700	5	80	R
2"	10		02 048 200	1 101,70	45,904		20	R

## Polypropylenové vnitřní tvarovky

02 101

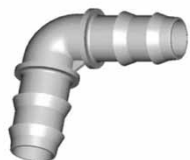

**koleno 90°**

d mm	PN bar	m g	objednáací kód	cena Kč	cena EUR	balení [ks]		sk
						MB	VB	
12	6		02 101 012	11,20	0,467	100		C
16	6		02 101 016	6,40	0,256	100	1200	R
20	6		02 101 020	7,20	0,288	100	700	R
25	6		02 101 025	16,40	0,656	50	350	R
32	6		02 101 032	21,40	0,856	50	200	R

02 106



**koleno 90° s vnějším závitem**

d x R	PN bar	m g	objednáací kód	cena Kč	cena EUR	balení [ks]		sk
						MB	VB	
16 x 1/2"	6		02 106 016 012	10,90	0,436	100	1000	R
16 x 3/4"	6		02 106 016 034	11,60	0,356	100	700	R
20 x 1/2"	6		02 106 020 012	9,50	0,380	100	700	R
20 x 3/4"	6		02 106 020 034	9,50	0,380	100	600	R
25 x 3/4"	6		02 106 025 034	22,40	0,896	50	400	R
25 x 1"	6		02 106 025 100	22,40	0,896	50	300	R
32 x 3/4"	6		02 106 032 034	27,80	1,112	50		R
32 x 1"	6		02 106 032 100	27,80	1,112	50	200	R
32 x 1 1/4"	6		02 106 032 114	33,00	1,320	50	150	R

02 140

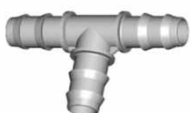

**T-kus 90°**

d mm	PN bar	m g	objednáací kód	cena Kč	cena EUR	balení [ks]		sk
						MB	VB	
12	6		02 140 012	15,40	0,642	100		C
16	6		02 140 016	5,00	0,200	250	1000	R
20	6		02 140 020	9,40	0,376	50	400	R
25	6		02 140 025	17,80	0,712	40	200	R
32	6		02 140 032	23,30	0,932	30	120	R

02 142



**T-kus 90° s vnějším závitem**

d x R x d	PN bar	m g	objednáací kód	cena Kč	cena EUR	balení [ks]		sk
						MB	VB	
16 x 1/2" x 16	6		02 142 016 012	9,50	0,380	100	600	R
16 x 3/4" x 16	6		02 142 016 034	9,50	0,380	100	400	R
20 x 1/2" x 20	6		02 142 020 012	13,70	0,548	50	450	R
20 x 3/4" x 20	6		02 142 020 034	13,70	0,548	50	350	R
25 x 1/2" x 25	6		02 142 025 012	19,20	0,768	50	250	R
25 x 3/4" x 25	6		02 142 025 034	19,20	0,768	50	200	R
25 x 1" x 25	6		02 142 025 100	20,10	0,804	30	180	R
32 x 3/4" x 32	6		02 142 032 034	26,70	1,068			R
32 x 1" x 32	6		02 142 032 100	26,10	1,044	30	120	R
32 x 1 1/4" x 32	6		02 142 032 114	28,50	1,140	50	100	R

02 177



**přechod s vnějším závitem**

d x R	PN bar	m g	objednáací kód	cena Kč	cena EUR	balení [ks]		sk
						MB	VB	
16 x 1/2"	6		02 177 016 012	8,10	0,324	100	1200	R
16 x 3/4"	6		02 177 016 034	6,90	0,276	100	700	R
20 x 1/2"	6		02 177 020 012	7,40	0,296	100	1000	R
20 x 3/4"	6		02 177 020 034	9,70	0,388	100	700	R
25 x 1/2"	6		02 177 025 012	8,00	0,320	100	700	R
25 x 3/4"	6		02 177 025 034	8,00	0,320	100	500	R
25 x 1"	6		02 177 025 100	9,20	0,368	50	400	R
32 x 3/4"	6		02 177 032 034	10,60	0,424	50	400	R
32 x 1"	6		02 177 032 100	1,50	0,060	50	300	R
32 x 1 1/4"	6		02 177 032 114	13,70	0,548	50	200	R



## Polypropylenové vnitřní tvarovky

### 02 160



#### spojka

d mm	PN bar	m g	objednací kód	cena Kč	cena EUR	balení [ks]		sk
						MB	VB	
12	6		02 160 012	13,70	0,571	100		C
16	6		02 160 016	5,00	0,200	500	1500	R
20	6		02 160 020	5,60	0,224	200	1000	R
25	6		02 160 025	7,70	0,308	100	500	R
32	6		02 160 032	9,90	0,396	50	250	R

### 02 151

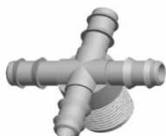

#### pěticečná rozbočka

d x R mm x inch	PN bar	m kg	objednací kód	cena Kč	cena EUR	balení [ks]		sk
						MB	VB	
16x16x16x16x16	6		02 151 016 016	15,40	0,616			R
16x16x3/4"x16x16	6		02 151 016 034	42,70	1,708	50	300	R

### 02 180



#### zátka

d mm	PN bar	m kg	objednací kód	cena Kč	cena EUR	balení [ks]		sk
						MB	VB	
16	6		02 180 016	2,20	0,088	500	3000	R
20	6		02 180 020	4,30	0,172	200	2000	R

## PP-B válcové kohouty

03 001



hadicový trn

d mm	PN bar	m g	objednáací kód	cena Kč	cena EUR	balení [ks]		sk
						MB	VB	
16	4		03 001 016	23,00	0,920	50	500	R
20	4		03 001 020	23,00	0,920	50	350	R
25	4		03 001 025	24,70	0,988	50	250	R

03 002



hadicový trn x vnější závit

d x G mm x inch	PN bar	m g	objednáací kód	cena Kč	cena EUR	balení [ks]		sk
						MB	VB	
16 x 1/2"	4		03 002 016 012	23,00	0,920	50	450	R
16 x 3/4"	4		03 002 016 034	23,00	0,920	50	400	R
20 x 1/2"	4		03 002 020 012	23,00	0,920	50	400	R
20 x 3/4"	4		03 002 020 034	23,00	0,920	50	350	R
25 x 3/4"	4		03 002 025 034	27,90	1,163	50	300	E

03 003



vnější závit

G inch	PN bar	m g	objednáací kód	cena Kč	cena EUR	balení [ks]		sk
						MB	VB	
1/2"	4		03 003 012	24,30	0,972	50	450	R
3/4" X 1/2"	4		03 003 034 012	24,30	0,972	50	400	R
3/4"	4		03 003 034	23,00	0,920	50	350	R

03 004



tape (0,15 - 0,65mm) x vnější závit

d x G mm x inch	PN bar	m g	objednáací kód	cena Kč	cena EUR	balení [ks]		sk
						MB	VB	
16 x 1/2"	4		03 004 016 012	29,70	1,188	50	350	R
16 x 3/4"	4		03 004 016 034	29,70	1,188	50	300	R
22 x 1/2"	4		03 004 022 012	33,90	1,356	50	250	R
22 x 3/4"	4		03 004 022 034	33,90	1,356	50	250	R

03 005



tape x tape (0,15 - 0,65mm)

d mm	PN bar	m g	objednáací kód	cena Kč	cena EUR	balení [ks]		sk
						MB	VB	
16	4		03 005 016	36,00	1,440	50	250	R
22	4		03 005 022	39,20	1,568	50	250	R

03 006



kapkovací trubka x vnější závit

d x G mm x inch	PN bar	m g	objednáací kód	cena Kč	cena EUR	balení [ks]		sk
						MB	VB	
16 x 1/2"	4		03 006 016 012	35,00	1,400	50	400	R
16 x 3/4"	4		03 006 016 034	35,00	1,400	50	400	R
20 x 1/2"	4		03 006 020 012	39,20	1,568	50	400	R
20 x 3/4"	4		03 006 020 034	39,20	1,568	50	350	R

03 007



kapkovací trubka x kapkovací trubka

d mm	PN bar	m g	objednáací kód	cena Kč	cena EUR	balení [ks]		sk
						MB	VB	
16	4		03 007 016	35,00	1,400	50	400	R
20	4		03 007 020	39,20	1,568	50	350	R

## PP-B válcové kohouty

03 013



**poly**

d mm	PN bar	m g	objednací kód	cena Kč	cena EUR	balení [ks]		sk
						MB	VB	
16	4		03 013 016	40,30	1,612	50	300	R

poly = pro trubky se silou stěny 0,75-1,4mm

03 115



**EXCEL** převlečná matice x vnější závit

G x G inch	PN bar	m g	objednací kód	cena Kč	cena EUR	balení [ks]		sk
						MB	VB	
3/4" x 3/4"	4		03 115 034 034	55,60	2,224	50	150	R

vrtání d14

## Kapkovací trubky

04

### kapkovací trubka tlakově kompenzovaná



d - L mm - cm	PN bar	l/hod	objednáací kód	cena Kč/m	cena EUR	balení [ks]		sk
						VB	MB	
d16x1,1 - 33 / 100m černá	4	2,0	04 002 016 035	16,40	0,656			D
d16x1,1 - 33 / 50m hnědá	4	2,1	04 002 016 034	16,70	0,668			Z
d16x1,1 - 100 / 400m černá	4	1,5	04 001 016 100	13,10	0,546			H

Vnější průměr 16mm, síla stěny 1,1mm, doporučený pracovní tlak 1 - 3,5 bar, výtok vody je uveden na 1 kapkovač, barva černá nebo hnědá, doporučená filtrace 120 mesh, potrubí se fixuje k zemi bodci ve vzdálenosti 1 - 2 m, nebo se věší na háčky na nosný drát (např. vinice) po 0,8 - 1 m. Skladem trubky s roztečí kapkovačů 33cm a 100cm, lze dodat i jiné rozteče. Použití: výsadby, skleníky, sady, vinice atd.

04 010

### kapkovací trubka bez kompenzace tlaku



d - L mm - cm	PN bar	l/hod	objednáací kód	cena Kč/m	cena EUR	balení [ks]		sk
						VB	MB	
d16x1,1 - 20 / 50m černá	4	2,0	04 010 016 020	15,50	0,604			H

## Tvarovky pro kapkovací trubku s tl. stěny 0,9 - 1,3 mm

04 160

### spojka

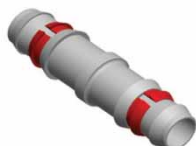

d mm	PN bar	m g	objednáací kód	cena Kč	cena EUR	balení [ks]		sk
						MB	VB	
16	4		04 160 016	5,70	0,228	100	1600	R
20	4		04 160 020	5,70	0,228	100	1000	R

04 120

### odbočka pro LDPE trubky



d mm	PN bar	m g	objednáací kód	cena Kč	cena EUR	balení [ks]		sk
						MB	VB	
16	4		04 120 016	6,10	0,244	100	1500	R
20	4		04 120 020	6,90	0,276	100	1200	R

světlost 9mm, doporučený otvor 11 - 12mm

04 121

### odbočka pro PVC nebo HDPE trubky



d mm	PN bar	m g	objednáací kód	cena Kč	cena EUR	balení [ks]		sk
						MB	VB	
16	4		04 121 016	10,20	0,408	100	1000	R
20	4		04 121 020	10,10	0,404	100	90	R

světlost 9 mm, doporučený otvor 15mm

04 180

### zátka



d mm	PN bar	m g	objednáací kód	cena Kč	cena EUR	balení [ks]		sk
						MB	VB	
16	4		04 180 016	7,60	0,304	100	3000	R
20	4		04 180 020	8,80	0,352	100	1500	R

04 177

### přechod s vnějším závitem



d x G mm x inch	PN bar	m g	objednáací kód	cena Kč	cena EUR	balení [ks]		sk
						MB	VB	
16 x 1/2"	4		04 177 016 012	8,50	0,340	100	1100	R
16 x 3/4"	4		04 177 016 034	11,90	0,476	100	800	R
20 x 1/2"	4		04 177 020 012	10,60	0,424	100	800	R
20 x 3/4"	4		04 177 020 034	10,60	0,424	100	700	R

04 140

### T - kus 90°

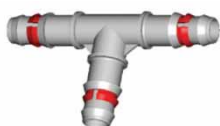

d mm	PN bar	m g	objednáací kód	cena Kč	cena EUR	balení [ks]		sk
						MB	VB	
16	4		04 140 016	21,30	0,852	200	600	R
20	4		04 140 020	16,60	0,664	50	400	R

## Tvarovky pro kapkovací trubku s tl. stěny 0,9 - 1,3 mm

04 142



T - kus 90° přechodový s vnějším závitem

d x G x d mm x inch x mm	PN bar	m g	objednáací kód	cena Kč	cena EUR	balení [ks]		sk
						MB	VB	
16 x 1/2" x 16	4		04 142 016 012	16,60	0,664	100	500	R
16 x 3/4" x 16	4		04 142 016 034	16,60	0,664	100	400	R
20 x 1/2" x 20	4		04 142 020 012	19,00	0,760	50	350	R
20 x 3/4" x 20	4		04 142 020 034	19,00	0,760	50	300	R

04 101



koleno 90°

d mm	PN bar	m g	objednáací kód	cena Kč	cena EUR	balení [ks]		sk
						MB	VB	
16	4		04 101 016	16,90	0,676	100	1000	R
20	4		04 101 020	14,20	0,568	100	600	R

04 106



koleno 90° přechodové s vnějším závitem

d x G mm x inch	PN bar	m g	objednáací kód	cena Kč	cena EUR	balení [ks]		sk
						MB	VB	
16 x 1/2"	4		04 106 016 012	13,30	0,532	100	900	R
16 x 3/4"	4		04 106 016 034	13,30	0,532	100	700	R
20 x 1/2"	4		04 106 020 012	15,50	0,620	100	700	R
20 x 3/4"	4		04 106 020 034	15,50	0,620	100	500	R

04 152



závěs pro trubku

d mm	PN bar	m g	objednáací kód	cena Kč	cena EUR	balení [ks]		sk
						MB	VB	
16			04 152 016	1,10	0,044		4000	R
16 - 20			04 152 017	1,20	0,048		6000	R
20			04 152 020	1,40	0,056		3000	R
25			04 152 025	1,80	0,072		2000	R
32			04 152 032	2,80	0,112		2000	R

04 152



závěs pro trubku "water run stopper"

d mm	PN bar	m g	objednáací kód	cena Kč	cena EUR	balení [ks]		sk
						MB	VB	
16			04 152 018	1,20	0,048	1000	10000	R

04 150



bodec

d mm	PN bar	m g	objednáací kód	cena Kč	cena EUR	balení [ks]		sk
						MB	VB	
16			04 150 016	7,50	0,300		600	R
20			04 150 020	5,30	0,221			R

04 155



ukončovací osmička

d mm	PN bar	m g	objednáací kód	cena Kč	cena EUR	balení [ks]		sk
						MB	VB	
16			04 155 016	2,70	0,108	500	3000	R
20			04 155 020	3,10	0,124	200	2200	R

04 156



plastová spona

d mm	PN bar	m g	objednáací kód	cena Kč	cena EUR	balení [ks]		sk
						MB	VB	
16-18			04 156 016	6,00	0,250	100		F
20-23			04 156 020	7,90	0,329	100		F

## Kapkovací pásy P1

04 201



### kapkovací pásek 0,2mm (8 mil) 1,5 l/hod

d - L mm - cm	PN bar	m g	objednací kód	cena Kč/m	cena EUR	balení [ks]		sk
						MB	VB	
d16 - 30 / 2500m	1		04 201 010	3,50	0,138			H

### kapkovací pásek 0,38mm (15 mil) 1,5 l/hod

d - L mm - cm	PN bar	m g	objednací kód	cena Kč/m	cena EUR	balení [ks]		sk
						VB	MB	
d16 - 30 / 1400m	1,8		04 201 040	6,30	0,246			H

Kapkovací pásy mohou být dodány v různých tloušťkách stěny, průměrech 16 a 22 mm, různých roztečích kapkovačů a různých průtocích kapkovačů. Kontaktujte nás prosím pro návrh a nabídku optimálního řešení pro Vaši závlahu. Barva černá, doporučená filtrace 120 mesh.

## Tvarovky pro kapkovací pásy Tape s tl. stěny 0,15 - 0,65 mm

04 360



### spojka

d mm	PN bar	m g	objednací kód	cena Kč	cena EUR	balení [ks]		sk
						MB	VB	
16	4		04 360 016	9,80	0,392	50	500	R
22	4		04 360 022	21,40	0,856	50	350	R

04 377



### přechod s vnějším závitem

d x G mm x inch	PN bar	m g	objednací kód	cena Kč	cena EUR	balení [ks]		sk
						MB	VB	
16 x 1/2"	4		04 377 016 012	10,00	0,400	100	700	R
16 x 3/4"	4		04 377 016 034	10,30	0,412	100	500	R
22 x 1/2"	4		04 377 022 012	15,30	0,612	50	500	R
22 x 3/4"	4		04 377 022 034	15,30	0,612	50	400	R

04 320



### odbočka pro LDPE trubky

d mm	PN bar	m g	objednací kód	cena Kč	cena EUR	balení [ks]		sk
						MB	VB	
16	4		04 320 016	8,90	0,356	100	800	R
22	4		04 320 022	17,40	0,696	100	600	R

světlost 9mm, doporučený otvor 11 - 12mm

04 321



### odbočka XL pro LDPE trubky

d mm	PN bar	m g	objednací kód	cena Kč	cena EUR	balení [ks]		sk
						MB	VB	
22	4		04 321 022	20,50	0,820	100	500	R

světlost 14mm, doporučený otvor 18mm

## Tvarovky pro kapkovací pásky Tape s tl. stěny 0,15 - 0,65 mm

04 322



odbočka pro PVC nebo HDPE trubky

d mm	PN bar	m g	objednací kód	cena Kč	cena EUR	balení [ks]		sk
						MB	VB	
16	4		04 322 016	12,80	0,512	100	600	R
22	4		04 322 022	21,40	0,856	100	400	R

světlost 9mm, doporučený otvor 15mm

04 323



odbočka pro Layflat trubky s maticí se šestihranem

d mm	PN bar	m g	objednací kód	cena Kč	cena EUR	balení [ks]		sk
						MB	VB	
16	4		04 323 016	18,00	0,720	50	400	R
22	4		04 323 022	29,30	1,172	100	300	R

světlost 10,4mm, doporučený otvor 14mm

04 380



zátka

d mm	PN bar	m g	objednací kód	cena Kč	cena EUR	balení [ks]		sk
						MB	VB	
16	4		04 380 016	11,40	0,456	100	900	R
22			04 380 022	15,50	0,620	50	550	R

04 340



T- kus 90°

d mm	PN bar	m g	objednací kód	cena Kč	cena EUR	balení [ks]		sk
						MB	VB	
16	4		04 340 016	29,70	1,188	50	200	R
22	4		04 340 022	52,30	2,092	50	150	R

04 342



T-kus 90°přechodový s vnějším závitem

d x G x d mm x inch x mm	PN bar	m g	objednací kód	cena Kč	cena EUR	balení [ks]		sk
						MB	VB	
16 x 1/2" x 16	4		04 342 016 012	33,90	1,356	50	300	R
16 x 3/4" x 16	4		04 342 016 034	33,90	1,356	50	250	R
22 x 1/2" x 22	4		04 342 022 012	47,50	1,900			R
22 x 3/4" x 22	4		04 342 022 034	47,50	1,900	50	200	R

04 301



koleno 90°

d mm	PN bar	m g	objednací kód	cena Kč	cena EUR	balení [ks]		sk
						MB	VB	
16	4		04 301 016	25,40	1,016	50	400	R
22	4		04 301 022	45,70	1,828	50	250	R

04 306



koleno 90° s vnějším závitem

d x G mm x inch	PN bar	m g	objednací kód	cena Kč	cena EUR	balení [ks]		sk
						MB	VB	
16 x 1/2"	4		04 306 016 012	30,80	1,232	50	500	R
16 x 3/4"	4		04 306 016 034	30,80	1,232	50	400	R
22 x 1/2"	4		04 306 022 012	37,30	1,492	50	450	R
22 x 3/4"	4		04 306 022 034	37,30	1,492			R

05 002



PP filtr síťový FLD bez vložky

G inch	PN bar	m kg	objednáací kód	cena Kč	cena EUR	balení [ks]		sk
						MB	VB	
3/4"	8		05 002 034	89,00	3,708			F
1"	8		05 002 100	98,00	4,083			F

síťová vložka polyester pro filtr FLD

	barva	objednáací kód	cena Kč	cena EUR	balení [ks]		sk
					MB	VB	
50mesh/300micron	tmavě modrá	05 002 021	126,00	5,250			F
75mesh/200micron	bílá	05 002 022	126,00	5,250			F
100mesh/160micron	světle modrá	05 002 023	126,00	5,250			F
120mesh/130micron	červená	05 002 024	126,00	5,250			F
155mesh/100micron	žlutá	05 002 025	126,00	5,250			F

síťová vložka nerezová pro filtr FLD

	barva	objednáací kód	cena Kč	cena EUR	balení [ks]		sk
					MB	VB	
75mesh/200micron	bílá	05 002 026	126,00	5,250			F
100mesh/160micron	světle modrá	05 002 027	126,00	5,250			F
120mesh/130micron	červená	05 002 028	126,00	5,250			F
155mesh/100micron	žlutá	05 002 029	126,00	5,250			F

05 003



PP filtr síťový FLE bez vložky

G inch	PN bar	m kg	objednáací kód	cena Kč	cena EUR	balení [ks]		sk
						MB	VB	
5/4"	8		05 003 114	194,00	8,083			F
6/4"	8		05 003 112	212,00	8,833			F

síťová vložka polyester pro filtr FLE

	barva	objednáací kód	cena Kč	cena EUR	balení [ks]		sk
					MB	VB	
50mesh/300micron	tmavě modrá	05 003 021	154,00	6,417			F
75mesh/200micron	bílá	05 003 022	154,00	6,417			F
100mesh/160micron	světle modrá	05 003 023	154,00	6,417			F
120mesh/130micron	červená	05 003 024	154,00	6,417			F
155mesh/100micron	žlutá	05 003 025	154,00	6,417			F

síťová vložka nerezová pro filtr FLE

	barva	objednáací kód	cena Kč	cena EUR	balení [ks]		sk
					MB	VB	
50mesh/300micron	tmavě modrá	05 003 026	154,00	6,417			F
75mesh/200micron	bílá	05 003 027	154,00	6,417			F
100mesh/160micron	světle modrá	05 003 028	154,00	6,417			F
120mesh/130micron	červená	05 003 029	154,00	6,417			F
155mesh/100micron	žlutá	05 003 030	154,00	6,417			F

05 004



PP filtr síťový FLF 2" vložka polyester

G inch	PN bar	m kg	objednáací kód	cena Kč	cena EUR	balení [ks]		sk
						MB	VB	
6/4"	8		05 004 112	415,00	17,292			F
2"	8		05 004 200	451,00	18,792			F

síťová vložka polyester pro filtr FLF

	barva	objednáací kód	cena Kč	cena EUR	balení [ks]		sk
					MB	VB	
30mesh/500micron	zelená	05 004 021	238,00	9,917			F
50mesh/300micron	tmavě modrá	05 004 022	238,00	9,917			F
75mesh/200micron	bílá	05 004 023	238,00	9,917			F
100mesh/160micron	světle modrá	05 004 024	238,00	9,917			F
120mesh/130micron	červená	05 004 025	238,00	9,917			F
155mesh/100micron	žlutá	05 004 026	238,00	9,917			F



**sítová vložka nerez pro filtr FLF**

	barva	objednáací kód	cena Kč	cena EUR	balení [ks]		sk
					MB	VB	
30mesh/500micron	zelená	05 004 027	238,00	9,917			F
50mesh/300micron	tmavě modrá	05 004 028	238,00	9,917			F
75mesh/200micron	bílá	05 004 029	238,00	9,917			F
100mesh/160micron	světle modrá	05 004 030	238,00	9,917			F
120mesh/130micron	červená	05 004 031	238,00	9,917			F
155mesh/100micron	žlutá	05 004 032	238,00	9,917			F

**05 010**

**PP filtr diskový**

G inch	PN bar	m kg	objednáací kód	cena Kč	cena EUR	balení [ks]		sk
						MB	VB	
DFLD 3/4" - 120mesh	8		05 010 001	297,00	12,375			F
DFLD 1" - 120mesh	8		05 010 002	319,00	13,292			F
DFLE 5/4" - 120mesh	8		05 011 001	460,00	19,167			F
DFLF 6/4" - 120mesh	8		05 012 001	819,00	34,125			F
DFLF 2" - 120mesh	8		05 012 002	870,00	36,250			F

**náhradní disková vložka pro filtr**

	PN bar	m kg	objednáací kód	cena Kč	cena EUR	balení [ks]		sk
						MB	VB	
DFLD - 120mesh	8		05 010 003	189,00	7,875			F
DFLE - 120mesh	8		05 011 002	318,00	13,250			F
DFLF - 120mesh	8		05 012 003	566,00	23,583			F

**05 003**

**PP filtr sítový včetně vložky nerez 130 micron**

G inch	PN bar	m kg	objednáací kód	cena Kč	cena EUR	balení [ks]		sk
						MB	VB	
5/4"	8		05 003 031	440,70	17,628			E

**náhradní sítová vložka nerez**

	barva	objednáací kód	cena Kč	cena EUR	balení [ks]		sk
					MB	VB	
120mesh/130micron		05 003 032	306,00	12,240			E

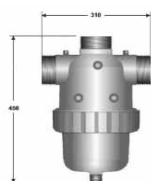
**05 014**

**filtr**

G inch	PN bar	m kg	objednáací kód	cena Kč	cena EUR	balení [ks]		sk
						MB	VB	
2" - 120mesh 30m3/hod	8		05 014 001	5 017,30	200,692			D
3" - 120mesh 50m3/hod	8		05 014 002	5 900,00	222,642			B

06 001



rozebiratelný kapkovač s držákem pro trubku d16 s vývodem

průtok l/h (1 bar)	PN bar	m g	objednáací kód	cena Kč	cena EUR	balení [ks]		sk
						MB	VB	
4	4		06 001 001	5,70	0,228		1 200	A
8	4		06 001 002	5,70	0,228		1 200	A
16	4		06 001 003	5,70	0,228		1 200	A

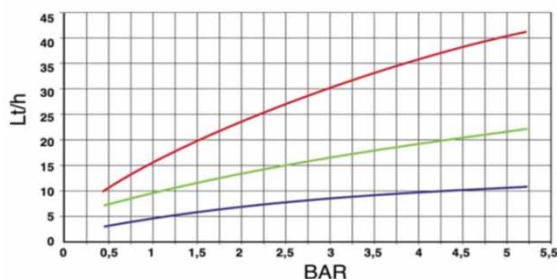

06 002



rozprašovač 180° se závitem M5

otvor d mm	PN bar	m g	objednáací kód	cena Kč	cena EUR	balení [ks]		sk
						MB	VB	
d1,5 červený			06 002 001	1,70	0,068			A
d2 černý			06 002 002	1,70	0,068			A



rozebiratelný rozprašovač dvoudílný

výšeč - otvor d mm	PN bar	m g	objednáací kód	cena Kč	cena EUR	balení [ks]		sk
						MB	VB	
180° - d1 červený			06 002 011	3,50	0,140			A
180° - d1,5 černý			06 002 012	3,50	0,140			A
180° - d2 modrý			06 002 013	3,50	0,140			A
180° - d2,3 zelený			06 002 014	3,50	0,140			A
360° x 4 - d1 červený			06 002 021	3,50	0,140			A
360° x 4 - d1,5 černý			06 002 022	3,50	0,140			A
360° x 4 - d2 modrý			06 002 023	3,50	0,140			A
360° x 4 - d2,3 zelený			06 002 024	3,50	0,140			A
360° x 12 - d1 červený			06 002 031	3,50	0,140			A
360° x 12 - d1,5 černý			06 002 032	3,50	0,140			A
360° x 12 - d2 modrý			06 002 033	3,50	0,140			A
360° x 12 - d2,3 zelený			06 002 034	3,50	0,140			A

tryska rozprašovače

otvor d mm	PN bar	m g	objednáací kód	cena Kč	cena EUR	balení [ks]		sk
						MB	VB	
d1 červený			06 002 041	1,80	0,072			A
d1,5 černý			06 002 042	1,80	0,072			A
d2 modrý			06 002 043	1,80	0,072			A
d2,3 zelený			06 002 044	1,80	0,072			A

čepička rozprašovače

otvor d mm	PN bar	m g	objednáací kód	cena Kč	cena EUR	balení [ks]		sk
						MB	VB	
180°			06 002 051	1,70	0,068			A
360° x 4 jet			06 002 052	1,70	0,068			A
360° x 12			06 002 053	1,70	0,068			A

tlak bar	Průtok l/h	poloměr dostřiku [m]		
		180°	360° x 4 (jet)	360° x 12
<b>d1 červený</b>				
0,5	23	1,5	1,5	1,5
1,0	33	1,7	1,6	1,8
1,5	41	2,0	1,9	2,2
2,0	47	2,2	2,0	2,4
2,5	53	2,3	2,2	2,5
<b>d1,5 černý</b>				
0,5	56	1,8	1,6	1,8
1,0	77	2,0	1,9	2,3
1,5	95	2,7	2,4	2,8
2,0	111	3,2	2,9	3,1
2,5	124	3,6	3,2	3,4
<b>d2 modrý</b>				
0,5	79	1,8	1,9	2,0
1,0	100	2,2	2,0	2,2
1,5	142	2,7	2,4	3,0
2,0	180	3,3	2,8	3,3
2,5	195	3,9	3,1	3,6
<b>d2,3 zelený</b>				
0,5	95	1,9	2,0	2,5
1,0	140	2,5	2,2	2,8
1,5	173	2,8	2,4	3,3
2,0	195	3,5	2,9	3,6
2,5	220	3,8	3,6	3,8

**06 030**

**odbočka pro PE/PVC trubičky 4 mm**

DN mm	PN bar	m g	objednáací kód	cena Kč	cena EUR	balení [ks]		sk
						MB	VB	
4	4		06 030 004	1,00	0,040			A

**06 032**

**závitový adaptér pro PE/PVC trubičku 4 mm**

DN mm	PN bar	m g	objednáací kód	cena Kč	cena EUR	balení [ks]		sk
						MB	VB	
4	4		06 032 004	2,20	0,088			A

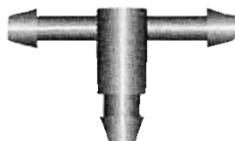
**06 031**

**T- kus pro PE/PVC trubičku 4 mm**

DN mm	PN bar	m g	objednáací kód	cena Kč	cena EUR	balení [ks]		sk
						MB	VB	
4	4		06 031 004	3,50	0,140			A

**06 050**

**bodec pro mikrotrubku 5 - 6 mm**

DN mm	PN bar	m g	objednáací kód	cena Kč	cena EUR	balení [ks]		sk
						MB	VB	
5 - 6	4		06 050 001	1,90	0,076			A

**06 033**

**zátky**

DN mm	PN bar	m g	objednáací kód	cena Kč	cena EUR	balení [ks]		sk
						MB	VB	
4	4		06 033 004	0,70	0,028			A
6	4		06 033 006	1,30	0,052			A

## 06 003

### tryska MINICOMPACT



Tryska MINICOMPACT je určena k zavěšení a závlaze shora dolů. Jedná se o celokruhové provedení s násuvným konusem 6mm vnějším. Doporučený pracovní tlak 1,0 - 2,5bar, optimální pracovní tlak 2,0bar. Doporučená filtrace minimálně 75 - 100mesh. Vhodné použití s protizakapávacím ventilem. Používá se pro zavlažování shora dolů ve sklenících, školkách a pěstebnách.

specifikace	PN bar	m g	objednací kód	cena Kč	cena EUR	balení [ks]		sk
						MB	VB	
modrá 0,9mm R 3,4m 40l/hod při 2,0bar			06 003 001	31,00	1,292			F
zelená 1,3mm R 4,0m 90l/hod při 2,0bar			06 003 002	31,00	1,292			F
hnědá 1,8mm R 4,4m 160l/hod při 2,0bar			06 003 003	31,00	1,292			F

### protivykapávací ventil



Protivykapávací ventil zamezuje vykapávání vody z rozvodného potrubí po skončení závlahy. Připojení konus 6mm vnější x vnitřní. Otevírací tlak 0,8 - 1,2bar, zavírací tlak 0,3 - 0,4bar. Maximální tlak 4bary. Doporučená filtrace minimálně 75 - 100mesh.

specifikace	PN bar	m g	objednací kód	cena Kč	cena EUR	balení [ks]		sk
						MB	VB	
protivykapávací ventil			06 003 090	45,00	1,875			F

### připojovací adaptér



Používá se pro připojení trysky k rozvodnému potrubí PVC nebo HDPE. Pro PVC trubku použít v kombinaci s montážní hmoždinkou 06 003 096. Do PE trubky předvrtat otvor 9mm

specifikace	PN bar	m g	objednací kód	cena Kč	cena EUR	balení [ks]		sk
						MB	VB	
adaptér W3/8" x konus 6mm			06 003 095	19,80	0,825			E

### montážní hmoždinka



Pro připojovací adaptér W3/8" nebo trysky se závitem W3/8" pro montáž do PVC trubky. Vkládá se do otvoru 11,5mm.

specifikace	PN bar	m g	objednací kód	cena Kč	cena EUR	balení [ks]		sk
						MB	VB	
montážní hmoždinka			06 003 096	11,70	0,488			E

## 40 504

### trubka pro mikrozávlahu



d x e mm	PN bar	m g	objednací kód	cena Kč/m	cena EUR	balení [ks]		sk
						MB	VB	
16 x 1,4 / 25m	4		40 504 016 124	18,80	0,783			H
16 x 1,4 / 100m	4		40 504 016 126	14,00	0,583			H

## Zavlažování příslušenství

07 004



### Ms rychlospojka na hadici

d mm	PN bar	m kg	objednáací kód	cena Kč	cena EUR	balení [ks]		sk
						MB	VB	
1/2" (12-15mm)			07 004 021	93,00	3,875			N
3/4" (19mm)			07 004 022	121,00	4,833			N

07 004



### Ms adaptér rychlospojky

d mm	PN bar	m kg	objednáací kód	cena Kč	cena EUR	balení [ks]		sk
						MB	VB	
1/2"			07 004 030	34,00	1,417			N
3/4"			07 004 031	36,00	1,500			N
1"			07 004 032	39,50	1,646			N

07 005



### Ms tryska s plynulou regulací a adaptérem

	PN bar	m kg	objednáací kód	cena Kč	cena EUR	balení [ks]		sk
						MB	VB	
Ms tryska			07 005 001	103,00	4,292			N

07 010



### zásuvka s ventilem

R mm	PN bar	m g	objednáací kód	cena Kč	cena EUR	balení [ks]		sk
						MB	VB	
3/4"	4	0,101	07 010 001	232,80	9,312		50	A
1"	4	0,106	07 010 002	232,80	9,312		50	A

07 010



### zástrčka pro zásuvku s ventilem

d mm	PN bar	m g	objednáací kód	cena Kč	cena EUR	balení [ks]		sk
						MB	VB	
3/4" / 1"	4	0,101	07 010 003	98,30	3,932		100	A

07 004



### plastový adaptér rychlospojky

d mm	PN bar	m kg	objednáací kód	cena Kč	cena EUR	balení [ks]		sk
						MB	VB	
1/2"			07 004 001	13,00	0,542			H
3/4"			07 004 002	21,00	0,875			H
1"			07 004 003	35,00	1,458			H

07 004



### plastová rychlospojka na hadici

d mm	PN bar	m kg	objednáací kód	cena Kč	cena EUR	balení [ks]		sk
						MB	VB	
1/2"			07 004 011	26,40	1,056			E
3/4"			07 004 012	30,80	1,232			E

07 001



### redukční ventil in-line plastový 3/4" FF

	PN bar	m kg	objednáací kód	cena Kč	cena EUR	balení [ks]		sk
						MB	VB	
LO-FLO 1,4bar	6		07 001 002	322,00	13,417			N
LO-FLO 1,7bar	6		07 001 003	322,00	13,417			N
HI-FLO 2,1bar	6		07 001 013	428,00	17,833			N
HI-FLO 2,8bar	6		07 001 014	428,00	17,833			N

LO-FLO 0,7-2,7 m3/hod

HI-FLO 0,5-4,5 m3/hod

13 004

### hadice Profi

hadice MPVC, neprůhledná černá duše, neprůhledný modrý obal, dvouvrstvé opletení polyesterovou přízí



modrá  
modrá  
zelená  
modrá  
modrá  
zelená  
modrá

d mm	PN bar	m kg	objednáací kód	cena Kč	cena EUR	balení [ks]		sk
						MB	VB	
1/2" (12,7/17,3) / 25m	10		13 004 012 025m	14,50	0,604			Z
1/2" (12,7/17,3) / 50m	10		13 004 012 050m	23,10	0,963			Z
1/2" (12,7/17,3) / 25m	10		13 004 012 025z	14,50	0,604			Z
3/4" (19/26) / 25m	10		13 004 019 025m	52,00	2,167			Z
3/4" (19/26) / 50m	10		13 004 019 050m	52,00	2,167			Z
3/4" (19/26) / 25m	10		13 004 019 025z	52,00	2,167			Z
1" (25/32) / 25m	10		13 004 025 025m	72,60	3,025			Z

## Ms tvarovky a armatury

### 14 001



#### Ms koleno

G inch	PN bar	m kg	objednací kód	cena Kč	cena EUR	balení [ks]		sk
						MB	VB	
1/4"			14 001 014	30,20	1,258			E
1/2"			14 001 012	43,70	1,821			E
3/4"			14 001 034	70,20	2,925			E
1"			14 001 100	113,00	4,708			E
5/4"			14 001 114	180,20	7,508			E
6/4"			14 001 112	237,70	9,904			E
2"			14 001 200	403,80	16,825			E

### 14 040



#### Ms T-kus

G inch	PN bar	m kg	objednací kód	cena Kč	cena EUR	balení [ks]		sk
						MB	VB	
1/4"			14 040 014	35,30	1,471			E
1/2"			14 040 012	56,50	2,354			E
3/4"			14 040 034	86,80	3,617			E
1"			14 040 100	150,70	6,279			E
5/4"			14 040 114	201,50	8,396			E
6/4"			14 040 112	261,20	10,883			E
2"			14 040 200	474,30	19,763			E

### 14 041



#### Ms T-kus redukovany

G inch	PN bar	m kg	objednací kód	cena Kč	cena EUR	balení [ks]		sk
						MB	VB	
3/4" x 1/2" x 3/4"			14 041 034 012	79,30	3,304			E
1" x 1/2" x 1"			14 041 100 012	103,70	4,321			E
1" x 3/4" x 1"			14 041 100 034	120,20	5,008			E
5/4" x 1/2" x 5/4"			14 041 114 012	199,80	8,325			E
5/4" x 3/4" x 5/4"			14 041 114 034	225,30	9,388			E
5/4" x 1" x 5/4"			14 041 114 100	275,00	11,458			E

### 14 060



#### Ms spojka

G inch	PN bar	m kg	objednací kód	cena Kč	cena EUR	balení [ks]		sk
						MB	VB	
1/4"			14 060 014	19,80	0,825			E
1/2"			14 060 012	56,50	2,354			E
3/4"			14 060 034	86,80	3,617			E
1"			14 060 100	150,70	6,279			E
5/4"			14 060 114	105,80	4,408			E
6/4"			14 060 112	156,30	6,513			E
2"			14 060 200	309,70	12,904			E

### 14 085



#### Ms vsuvka

G inch	PN bar	m kg	objednací kód	cena Kč	cena EUR	balení [ks]		sk
						MB	VB	
1/4"			14 085 014	11,20	0,467			E
1/2"			14 085 012	21,70	0,904			E
3/4"			14 085 034	32,20	1,342			E
1"			14 085 100	61,70	2,571			E
5/4"			14 085 114	107,30	4,471			E
6/4"			14 085 112	134,30	5,596			E
2"			14 085 200	194,50	8,104			E

### 14 086



#### Ms vsuvka redukovana

G x G inch	PN bar	m kg	objednací kód	cena Kč	cena EUR	balení [ks]		sk
						MB	VB	
1/2" x 1/4"			14 086 012 014	33,00	1,375			E
3/4" x 1/2"			14 086 034 012	30,20	1,258			E
1" x 1/2"			14 086 100 012	60,50	2,521			E
1" x 3/4"			14 086 100 034	50,00	2,083			E
5/4" x 1"			14 086 114 100	81,70	3,404			E
6/4" x 1"			14 086 112 100	99,30	4,138			E
6/4" x 5/4"			14 086 112 114	106,00	4,417			E
2" x 1"			14 086 200 100	285,30	11,888			E
2" x 5/4"			14 086 200 114	168,20	7,008			E
2" x 6/4"			14 086 200 112	174,30	7,263			E

14 097



Ms redukce

G x G inch	PN bar	m kg	objednací kód	cena Kč	cena EUR	balení [ks]		sk
						MB	VB	
1/2" x 1/4"			14 097 012 014	20,80	0,867			E
3/4" x 1/2"			14 097 034 012	21,70	0,904			E
1" x 1/4"			14 097 100 014	146,90	6,121			E
1" x 1/2"			14 097 100 012	52,00	2,167			E
1" x 3/4"			14 097 100 034	39,20	1,633			E
5/4" x 1/2"			14 097 114 012	152,80	6,367			E
5/4" x 3/4"			14 097 114 034	88,70	3,696			E
5/4" x 1"			14 097 114 100	63,20	2,633			E
6/4" x 1/2"			14 097 112 012	237,20	9,883			E
6/4" x 3/4"			14 097 112 034	186,80	7,783			E
6/4" x 1"			14 097 112 100	108,20	4,508			E
6/4" x 5/4"			14 097 112 114	70,20	2,925			E
2" x 1/2"			14 097 200 012	327,30	13,638			E
2" x 3/4"			14 097 200 034	357,30	14,888			E
2" x 1"			14 097 200 100	191,00	7,958			E
2" x 5/4"			14 097 200 114	191,00	7,958			E
2" x 6/4"			14 097 200 112	160,50	6,688			E

14 101



Ms hadicový trn s vnějším závitem

d x G mm x inch	PN bar	m kg	objednací kód	cena Kč	cena EUR	balení [ks]		sk
						MB	VB	
d14 x 1/2"			14 101 014 012	29,70	1,238			E

14 102



Ms hadicový trn s převlečnou maticí

d x G mm x inch	PN bar	m kg	objednací kód	cena Kč	cena EUR	balení [ks]		sk
						MB	VB	
d13 x G1/2"			14 102 013 012	51,40	2,142			N
d13 x G3/4"			14 102 013 034	55,60	2,317			N
d13 x G1"			14 102 013 100	62,50	2,604			N

14 110



Ms šroubení přímé

G inch	PN bar	m kg	objednací kód	cena Kč	cena EUR	balení [ks]		sk
						MB	VB	
1/2"			14 110 012	74,20	3,092			E
3/4"			14 110 034	113,70	4,738			E
1"			14 110 100	191,50	7,979			E
5/4"			14 110 114	280,20	11,675			E
6/4"			14 110 112	367,20	15,300			E
2"			14 110 200	518,70	21,613			E

14 112



Ms půlšroubení

G inch	PN bar	m kg	objednací kód	cena Kč	cena EUR	balení [ks]		sk
						MB	VB	
1" x 5/4"			14 112 100	118,50	4,938			E

14 271



Ms zpětná klapka celokovová

G inch	PN bar	m kg	objednací kód	cena Kč	cena EUR	balení [ks]		sk
						MB	VB	
1/2"			14 271 012	96,70	4,029			E
3/4"			14 271 034	124,50	5,188			E
1"			14 271 100	213,80	8,908			E
5/4"			14 271 114	346,50	14,438			E
6/4"			14 271 112	523,30	21,804			E
2"			14 271 200	737,20	30,717			E

14 305



Ms kulový kohout zahradní

G inch	PN bar	m kg	objednací kód	cena Kč	cena EUR	balení [ks]		sk
						MB	VB	
1/2"			14 305 012	98,30	4,096			E
3/4"			14 305 034	131,00	5,458			E

## Ms tvarovky a armatury

14 302



### Ms kulový kohout vnitřní x vnitřní závit

G inch	PN bar	m kg	objednáací kód	cena Kč	cena EUR	balení [ks]		sk
						MB	VB	
1/2"			14 302 012	100,40	4,183			E
3/4"			14 302 034	131,40	5,475			E
1"			14 302 100	226,20	9,425			E
5/4"			14 302 114	384,20	16,008			E
6/4"			14 302 112	512,40	21,350			E
2"			14 302 200	784,10	32,671			E

14 303



### Ms kulový kohout vnitřní x vnější závit

G inch	PN bar	m kg	objednáací kód	cena Kč	cena EUR	balení [ks]		sk
						MB	VB	
1/2"			14 303 012	106,40	4,433			E
3/4"			14 303 034	142,20	5,925			E
1"			14 303 100	236,30	9,846			E

14 307



### Ms kulový kohout vnitřní x vnější závit, motýl

G inch	PN bar	m kg	objednáací kód	cena Kč	cena EUR	balení [ks]		sk
						MB	VB	
1/2"			14 307 012	101,70	4,238			E

14 390



### Ms odvzdušňovací ventil automatický

G inch	PN bar	m kg	objednáací kód	cena Kč	cena EUR	balení [ks]		sk
						MB	VB	
1/2"			14 390 001	230,90	9,621			E

14 140



### Ms prodloužení kované

G - L inch - mm	PN bar	m kg	objednáací kód	cena Kč	cena EUR	balení [ks]		sk
						MB	VB	
1/2" - 10			14 140 012 010	28,50	1,188			E
1/2" - 15			14 140 012 015	34,80	1,450			E
1/2" - 20			14 140 012 020	38,70	1,613			E
1/2" - 25			14 140 012 025	41,50	1,729			E
1/2" - 30			14 140 012 030	49,20	2,050			E
1/2" - 40			14 140 012 040	62,70	2,613			E
1/2" - 50			14 140 012 050	75,20	3,133			E



## PVC-U

### Materiál

PVC-U je stabilizovaný neplastifikovaný (neobsahuje změkčovadla) polyvinylchlorid a označuje se jako tvrdé PVC, neměkčené PVC nebo PVC-U. Materiál dále obsahuje barviva a stabilizátory proti UV záření a tepelné degradaci. PVC-U je materiál s velmi dobrými hydraulickými vlastnostmi, kdy se minimalizuje tvorba usazenin vzhledem k hladkosti vnitřního povrchu trubek. Materiál je klasifikován jako nesnadno hořlavý, podle ČSN EN 13501-1 je zařazen do třídy hořlavosti B. PVC je samozhášivý a hoří jen v trvalém zdroji

### fyzikální vlastnosti

vlastnost	metoda	hodnota
měrná hmotnost	ISO 1183	1,4 kg/dm <sup>3</sup>
protažení při přetržení	ISO R527	154%
modul pružnosti	ISO R527	2 600 MPa
odolnost v tahu	ISO R527	40 MPa
pevnost v tahu	ISO R527	44 MPa
bod měknutí podle Vicata 5kg	ISO 306	>76°C
tepelná vodivost při 23°C	ASTM C177	0,13 - 0,19 W/mK
koeficient délkové roztažnosti	ASTM D696	0,005 - 0,008 mm/m°C

### dovolený provozní tlak

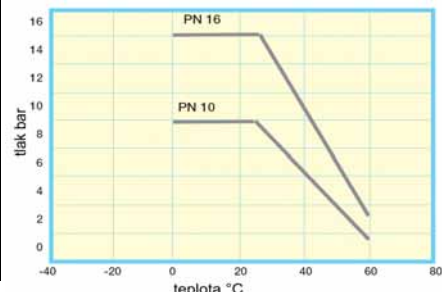

### Těsnění

Standartní těsnění jsou z EPDM (etylen-propylenová pryž), pokud není uvedeno jinak. Obvykle lze dodat také v provedení FPM (viton).

### Tlakový systém PVC

PVC trubky a tvarovky o průměru d16 až d315 lze použít pro rozvody pitné vody PN10 a PN16 podle EN nebo DIN a pro tlakové rozvody médií v průmyslových aplikacích. Trubky a tvarovky se spojují lepením, závitovými nebo přírubovými spoji.

### Oblast použití

Systém tlakových trubek, tvarovek a armatur z PVC-U, tlakových tříd PN6 - PN16, spojovaných lepením se používá všude tam, kde je vyžadována spolehlivost, snadná manipulace a montáž, mechanická a chemická odolnost potrubních dílů a v dalších oblastech, kde maximální trvalé teploty kapalin nebo okolí nepřesahují trvale 50 °C.

### Lze jej použít např. pro:

- dopravu studené pitné a užitkové vody (vně nebo uvnitř budov)
- dopravu odpadních vod podle jejich chemického složení
- dopravu pevných látek (za určených podmínek)
- úpravny a čistírny odpadních vod
- zavlažování
- dopravu technologických kapalin (celulózy, chemické, biochemické a farmaceutické provozy, elektrárny, teplárny, pivovary, laboratoře, nemocnice, strojírenství, doly, výroba kosmetiky, potravin)
- zemědělské provozy
- bazény, aquaparky
- tlakové a podtlakové (vakuové) kanalizace
- a mnoho dalších aplikací

### Dopravované kapaliny:

- většina běžných chemikálií, jako jsou vodné roztoky neoxidujících kyselin (kromě silně oxidujících kyselin jako HNO<sub>3</sub> apod.)
- vodné roztoky zásad, alkoholů, aldehydů, peroxidů, benzín, oleje, průmyslové odpadní vody
- rozsah pH roztoků 2-12

### Nelze dopravovat:

- aromatické a chlorované sloučeniny
- kapaliny s trvalou teplotou nad 50 °C
- pevné a sypké látky, které indukují vznik elektrostatického náboje

## PVC-U tlakové trubky na lepení



### PVC tlakové trubky PN16 bez hrdla, barva šedá

d x e mm	PN bar	m kg/m	objednáací kód	cena Kč/m	cena EUR	sk
12 x 1,1 / 5m	16	0,062	32 517 012 005	49,70	2,071	D
16 x 1,5 / 5m	16	0,093	32 517 016 005	32,60	1,358	B
20 x 1,5 / 5m	16	0,137	32 517 020 005	30,20	1,258	B
25 x 1,9 / 5m	16	0,212	32 517 025 005M	45,60	1,824	A
32 x 2,4 / 5m	16	0,343	32 517 032 005M	52,50	2,100	A
40 x 3,0 / 5m	16	0,526	32 517 040 005M	75,00	3,000	A
50 x 3,7 / 5m	16	0,811	32 517 050 005M	115,00	4,600	A
63 x 4,7 / 5m	16	1,290	32 517 063 005M	183,10	7,324	A
75 x 5,6 / 5m	16	1,499	32 517 075 005	327,60	13,650	B
90 x 6,7 / 5m	16	2,151	32 517 090 005	443,70	18,488	B
110 x 6,6 / 5m	16	3,196	32 517 110 005	549,50	22,896	B

#### hrdlo na lepení

125 x 7,4 / 6m	16	4,060	32 516 125 006	719,90	29,996	B
140 x 8,3 / 6m	16	4,100	32 516 140 006	798,00	33,250	B
160 x 9,5 / 6m	16	6,670	32 516 160 006	993,10	41,379	B
180 x 10,7 / 6m	16		32 516 180 006	---	---	-
200 x 11,9 / 6m	16	10,440	32 516 200 006	1 735,00	72,292	B
225 x 13,4 / 6m	16	13,510	32 516 225 006	1 913,70	79,738	B
250 x 14,8 / 6m	16	16,550	32 516 250 006	2 694,00	112,250	B
280 x 16,6 / 6m	16		32 516 280 006	---	---	-
315 x 18,7 / 6m	16		32 516 315 006	---	---	-

### PVC tlakové trubky PN10 bez hrdla, barva šedá

32 x 1,6 / 5m	10	0,239	32 511 032 005	42,60	1,775	B
40 x 1,9 / 5m	10	0,350	32 511 040 005M	50,00	2,000	A
50 x 2,4 / 5m	10	0,553	32 511 050 005M	78,10	3,124	A
63 x 3,0 / 5m	10	0,704	32 511 063 005M	121,30	4,852	A
75 x 3,6 / 5m	10	0,997	32 511 075 005M	174,40	6,976	A
90 x 4,3 / 5m	10	1,443	32 511 090 005M	228,10	9,124	A
110 x 4,2 / 5m	10	2,113	32 511 110 005M	276,90	11,076	A
125 x 4,8 / 5m	10	2,718	32 511 125 005	474,30	19,763	B
140 x 5,4 / 5m	10	6,690	32 511 140 005M	448,80	17,952	A
160 x 6,2 / 5m	10	4,491	32 511 160 005M	588,10	23,524	A
200 x 7,7 / 5m	10	6,924	32 511 200 005	1 285,10	53,546	B
250 x 9,6 / 5m	10	10,769	32 511 250 005	2 084,30	86,846	B

#### hrdlo na lepení

d x e mm	PN bar	m kg/m	objednáací kód	cena Kč/m	cena EUR	sk
125 x 4,8 / 6m	10	2,718	32 510 125 006	400,90	16,704	B
140 x 5,4 / 6m	10	3,390	32 510 140 006	512,60	21,358	B
160 x 6,2 / 6m	10	4,491	32 510 160 006M	588,10	23,524	A
180 x 6,9 / 6m	10	5,790	32 510 180 006	734,50	30,604	B
200 x 7,7 / 6m	10	6,924	32 510 200 006	1 035,80	43,158	B
225 x 8,6 / 6m	10	8,680	32 510 225 006	1 300,00	54,167	B
250 x 9,6 / 6m	10	10,770	32 510 250 006	1 917,00	79,875	B
280 x 10,7 / 6m	10	13,430	32 510 280 006	2 018,80	84,117	B
315 x 12,1 / 6m	10	17,090	32 510 315 006	2 556,20	106,508	B
355 x 13,6 / 6m	10	21,650	32 510 355 006	2 104,90	87,704	B
400 x 15,3 / 6m	10	27,440	32 510 400 006	4 834,00	201,417	B

## PVC-U tlakové trubky na lepení

### PVC transparentní trubky bez hrdla, délka 5m

d x e mm	PN bar	m kg/m	objednáací kód	cena Kč/m	cena EUR		sk
16 x 1,5	16	0,101	32 519 016 005	170,00	7,083		H
20 x 1,5	16	0,129	32 519 020 005	243,00	10,125		H
25 x 1,9	16	0,205	32 519 025 005	344,00	14,333		H
32 x 2,4	16	0,331	32 519 032 005	443,00	18,458		H
40 x 3,0	16	0,525	32 519 040 005	719,00	29,958		H
50 x 3,7	16	0,809	32 519 050 005	1 209,00	50,375		H
32 x 1,6	10	0,227	32 518 032 005	381,00	15,875		H
40 x 1,9	10	0,337	32 518 040 005	533,00	22,208		H
50 x 2,4	10	0,533	32 518 050 005	673,00	28,042		H
63 x 3,0	10	0,839	32 518 063 005	1 025,00	42,708		H

## PVC hadice

### HH

#### hadice HYDRO

Hadice z měkčeného PVC s výstužnou spirálou z tvrdého PVC, barva šedá, vnější i vnitřní povrch hladký, tolerance vnějšího průměru +0,1 až +0,3 mm, teplotní rozmezí -10 °C až +60 °C, balení - návin 25 m

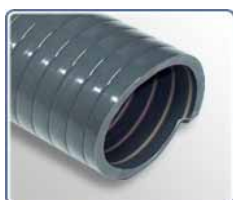

d x DN mm	PN bar	m kg/m	objednáací kód	cena Kč/m	cena EUR		sk
20 x 15	7	0,200	HH020	41,60	1,733		C
25 x 20	6		HH025	46,30	1,929		C
32 x 26	6	0,400	HH032	---	---		-
40 x 34	5	0,480	HH040	88,40	3,683		C
50 x 43 metráž	4	0,720	HH05001	135,00	5,625		E
50 x 43 návin 25m	4	0,720	HH05025	121,80	5,075		C
63 x 55 metráž	4	1,000	HH06301	186,00	7,750		E
63 x 55 návin 25m	4	1,000	HH06325	177,70	7,404		C
75 x 65	4	1,486	HH075	360,00	15,000		E

## PE korugované bazénové hadice

### HB

#### PE korugovaná bazénová hadice

UV stabilizovaná

DN32 - dělitelná po 1,1m

DN38 - dělitelná po 1,5m



DN mm	PN bar	m kg/m	objednáací kód	cena Kč/m	cena EUR	barva	sk
32 metráž		0,165	HB3201	55,50	2,313	modrá	C
32 návin 50,6m		0,165	HB3250	45,50	1,896	modrá	S
38 metráž		0,200	HB3801	64,50	2,688	modrá	C
38 návin 51m		0,200	HB3845	54,50	2,271	modrá	S
32 metráž		0,165	HB3201c	55,50	2,313	černá	C
32 návin 50,6m		0,165	HB3250c	45,50	1,896	černá	S
38 metráž		0,200	HB3801c	64,50	2,688	černá	C
38 návin 51m		0,200	HB3845c	54,50	2,271	černá	S

## PVC-UH tvarovky na lepení, závitové a přechodové

### 32 GOI



#### koleno 90° lepení

d mm	PN bar	m kg	objednací kód	cena Kč	cena EUR	balení [ks]		sk
						MB	VB	
12	16		32 GOI 012	22,70	0,95		250	E
16	16	0,009	32 GOI 016	12,30	0,49		350	A
20	16	0,015	32 GOI 020	14,70	0,59		250	A
25	16	0,025	32 GOI 025	16,00	0,64		300	A
32	16	0,041	32 GOI 032	18,50	0,74		180	A
40	16	0,090	32 GOI 040	34,70	1,39		120	A
50	16	0,143	32 GOI 050	46,40	1,86		120	A
63	16	0,235	32 GOI 063	65,20	2,61		60	A
75	16	0,375	32 GOI 075	150,20	6,01		40	A
90	16	0,622	32 GOI 090	209,30	8,37		25	A
110	16	1,078	32 GOI 110	287,20	11,49		14	A
125	16	1,390	32 GOI 125	585,00	23,40		8	A
140	16	2,050	32 GOI 140	715,40	28,62		6	A
160	16	3,450	32 GOI 160	1 091,10	43,64		4	A
180	10	5,200	32 GOI 180	4 588,20	183,53		1	A
200	10	4,890	32 GOI 200	2 147,40	85,90		2	A
225	10	7,425	32 GOI 225	2 430,50	97,22		2	A
250	10	12,480	32 GOI 250	5 134,20	205,37		1	A
280	10	17,000	32 GOI 280	7 188,20	287,53		1	A
315	10	23,326	32 GOI 315	8 831,50	353,26		1	A

### 32 002



#### koleno 90° vnitřní x vnitřní/vnější lepení

d x d mm	PN bar	m kg	objednací kód	cena Kč	cena EUR	balení [ks]		sk
						MB	VB	
20 x 20/16	16	0,012	32 002 020	43,30	1,80			E
25 x 25/20	16	0,020	32 002 025	45,60	1,90			E
32 x 32/25	16	0,038	32 002 032	56,10	2,34			E
40 x 40/32	16	0,066	32 002 040	98,60	3,94			E
50 x 40/50	16	0,125	32 002 050	61,80	2,58		100	B
63 x 50/63	16	0,274	32 002 063	92,70	3,86		50	B

### 32 GOF



#### koleno 90° závitové

G inch	PN bar	m kg	objednací kód	cena Kč	cena EUR	balení [ks]		sk
						MB	VB	
3/8"	16	0,014	32 GOF 038	25,40	1,02		350	A
1/2"	16	0,022	32 GOF 012	20,90	0,84		600	A
3/4"	16	0,037	32 GOF 034	27,20	1,09		300	A
1"	16	0,062	32 GOF 100	31,40	1,26		170	A
1 1/4"	16	0,093	32 GOF 114	51,00	2,04		100	A
1 1/2"	16	0,180	32 GOF 112	76,70	3,07		60	A
2"	16	0,310	32 GOF 200	109,40	4,38		60	A
2 1/2"	16	0,425	32 GOF 212	267,00	10,68		40	A
3"	16	0,740	32 GOF 300	379,30	15,17		25	A
4"	16	1,050	32 GOF 400	623,30	24,93		14	A

### 32 GOP



#### koleno 90° lepení x vnitřní závit

d x G mm x inch	PN bar	m kg	objednací kód	cena Kč	cena EUR	balení [ks]		sk
						MB	VB	
16 x 3/8"	16	0,013	32 GOP 016 038	20,90	0,84		350	A
20 x 1/2"	16	0,021	32 GOP 020 012	25,10	1,00		600	A
25 x 3/4"	16	0,035	32 GOP 025 034	30,00	1,20		300	A
32 x 1"	16	0,060	32 GOP 032 100	38,90	1,56		180	A
40 x 1 1/4"	16	0,091	32 GOP 040 114	68,40	2,74		100	A
50 x 1 1/2"	16	0,155	32 GOP 050 112	93,40	3,74		60	A
63 x 2"	16	0,265	32 GOP 063 200	129,80	5,19		60	A
75 x 2 1/2"	16	0,400	32 GOP 075 212	281,00	11,24		40	A
90 x 3"	16	0,670	32 GOP 090 300	403,70	16,15		25	A
110 x 4"	16	1,055	32 GOP 110 400	621,20	24,85		14	A

## PVC-UH tvarovky na lepení, závitové a přechodové

### 32 GGP



#### koleno 90° se zpev. kroužkem lepení x vnitřní závit

d x G mm x inch	PN bar	m kg	objednáací kód	cena Kč	cena EUR	balení [ks]		sk
						MB	VB	
16 x 3/8"	16	0,014	32 GGP 016 038	98,30	3,93		1000	A
20 x 1/2"	16	0,031	32 GGP 020 012	39,70	1,59		250	A
25 x 3/4"	16	0,037	32 GGP 025 034	42,50	1,70		350	A
32 x 1"	16	0,062	32 GGP 032 100	57,90	2,32		180	A
40 x 1 1/4"	16	0,095	32 GGP 040 114	82,30	3,29		100	A
50 x 1 1/2"	16	0,160	32 GGP 050 112	117,80	4,71		60	A
63 x 2"	16	0,270	32 GGP 063 200	177,80	7,11		60	A

### 32 006



#### koleno 90° lepení x vnější závit

d x G mm x inch	PN bar	m kg	objednáací kód	cena Kč	cena EUR	balení [ks]		sk
						MB	VB	
20 x 3/4"	16		32 006 020 034	35,00	1,46		200	E
25 x 1"	16		32 006 025 100	39,10	1,63		350	E
32 x 3/4"	10		32 006 032 034	39,10	1,63		250	E
32 x 1"	10		32 006 032 100	46,00	1,92		250	E
32 x 1 1/4"	10		32 006 032 114	43,20	1,80		250	E
40 x 1 1/4"	10		32 006 040 114	52,10	2,17		200	E
40 x 1 1/2"	10		32 006 040 112	53,50	2,23		175	E
50 x 1 1/4"	10		32 006 050 114	63,80	2,66		150	E
50 x 1 1/2"	10		32 006 050 112	49,40	2,06		125	E
50 x 2"	10		32 006 050 200	70,00	2,92		100	E
63 x 2"	10		32 006 063 200	70,00	2,92			E

### 32 008



#### koleno 90° lepení AIR

d x G mm x inch	PN bar	m kg	objednáací kód	cena Kč	cena EUR	balení [ks]		sk
						MB	VB	
50 x 1/2"	16		32 008 050 012	87,50	3,65		30	E
63 x 1/2"	16		32 008 063 012	119,40	4,98		30	E
75 x 1/2"	16		32 008 075 012	179,90	7,50			E
90 x 3/4"	16		32 008 090 034	316,60	13,19			E
110 x 1"	16		32 008 110 100	539,50	22,48			E
125 x 2"	16		32 008 125 200	759,20	31,63			E
160 x 2"	16		32 008 160 200	1 414,40	58,93			E
200 x 2"	10		32 008 200 200	1 833,30	76,39			E

### 32 GTI

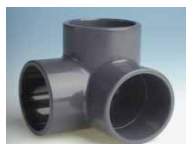

#### trojcestné koleno lepení

d mm	PN bar	m kg	objednáací kód	cena Kč	cena EUR	balení [ks]		sk
						MB	VB	
50	16	0,170	32 GTI 050	158,00	6,58			D
63	16	0,285	32 GTI 063	205,00	8,54			E

## PVC-UH tvarovky na lepení, závitové a přechodové

### 32 GYI



#### koleno 45° lepení

d mm	PN bar	m kg	objednáací kód	cena Kč	cena EUR	balení [ks]		sk
						MB	VB	
12	16		32 GYI 012	37,10	1,55		150	E
16	16	0,010	32 GYI 016	23,70	0,95		500	A
20	16	0,017	32 GYI 020	24,50	0,98		300	A
25	16	0,029	32 GYI 025	27,20	1,09		400	A
32	16	0,047	32 GYI 032	32,20	1,29		200	A
40	16	0,077	32 GYI 040	42,50	1,70		150	A
50	16	0,110	32 GYI 050	57,80	2,31		150	A
63	16	0,180	32 GYI 063	75,00	3,00		90	A
75	16	0,310	32 GYI 075	138,80	5,55		50	A
90	16	0,486	32 GYI 090	188,90	7,56		30	A
110	16	0,836	32 GYI 110	331,80	13,27		16	A
125	16	1,080	32 GYI 125	530,60	21,22		12	A
140	16	1,525	32 GYI 140	642,20	25,69		6	A
160	16	2,250	32 GYI 160	773,90	30,96		5	A
180	10		32 GYI 180	---	---			-
200	10	3,500	32 GYI 200	2 005,90	80,24		2	A
225	10	5,750	32 GYI 225	2 169,70	86,79		2	A
250	10	7,700	32 GYI 250	4 107,20	164,29		1	A
280	10	10,460	32 GYI 280	5 648,10	225,92		1	A
315	10	14,480	32 GYI 315	7 803,80	312,15		1	A

### 32 012



#### koleno 45° vnitřní x vnitřní/vnější lepení

d x d mm	PN bar	m kg	objednáací kód	cena Kč	cena EUR	balení [ks]		sk
						MB	VB	
20 x 20/16	16	0,009	32 012 020	78,30	3,26			E
25 x 25/20	16	0,016	32 012 025	79,50	3,31			E
32 x 32/25	16	0,030	32 012 032	92,40	3,85			E
40 x 40/32	16	0,051	32 012 040	126,30	5,26			E
50 x 40/50	16	0,090	32 012 050	72,10	3,00		120	B
63 x 50/63	16	0,176	32 012 063	105,50	4,40		60	B

### 32 GYF



#### koleno 45° závitové

G inch	PN bar	m kg	objednáací kód	cena Kč	cena EUR	balení [ks]		sk
						MB	VB	
3/8"	16	0,010	32 GYF 038	34,40	1,43			B
1/2"	16	0,018	32 GYF 012	43,10	1,72		300	A
3/4"	16	0,031	32 GYF 034	45,30	1,81		400	A
1"	16	0,051	32 GYF 100	58,80	2,35		200	A
1 1/4"	16	0,080	32 GYF 114	80,90	3,24		150	A
1 1/2"	16	0,155	32 GYF 112	119,80	4,79		150	A
2"	16	0,275	32 GYF 200	169,30	6,77		90	A
2 1/2"	16	0,360	32 GYF 212	381,40	15,26		50	A
3"	16	0,620	32 GYF 300	487,00	19,48		30	A
4"	16	0,830	32 GYF 400	780,90	31,24		16	A

## PVC-UH tvarovky na lepení, závitové a přechodové

### 32 015



#### koleno 45° se zpev. kroužkem lepení x vnitřní závit

d x G mm x inch	PN bar	m kg	objednací kód	cena Kč	cena EUR	balení [ks]		sk
						MB	VB	
20 x 1/2"	16	0,028	32 015 020 012	64,40	2,68		100	B
25 x 3/4"	16	0,039	32 015 025 034	73,40	3,06		100	B
32 x 1"	16	0,065	32 015 032 100	92,70	3,86		100	B
40 x 1 1/4"	16	0,089	32 015 040 114	109,40	4,56		110	B
50 x 1 1/2"	16	0,149	32 015 050 112	154,40	6,43		110	B
63 x 2"	16	0,259	32 015 063 200	208,50	8,69		55	B

### 32 CUI



R = 2d  
vstříkovaný

#### oblouk 90° lepení

d mm	PN bar	m kg	objednací kód	cena Kč	cena EUR	balení [ks]		sk
						MB	VB	
20	16	0,045	32 CUI 020	62,00	2,48		300	A
25	16	0,075	32 CUI 025	72,50	2,90		150	A
32	16	0,120	32 CUI 032	92,00	3,68		90	A
40	16	0,205	32 CUI 040	123,40	4,94		100	A
50	16	0,310	32 CUI 050	174,30	6,97		50	A
63	16	0,510	32 CUI 063	230,50	9,22		25	A
75	16	0,995	32 CUI 075	506,90	20,28		15	A
90	16	1,765	32 CUI 090	629,60	25,18		8	A
110	16	2,805	32 CUI 110	1 020,00	40,80		5	A

### 32 105/106



R = 1,8d pro d32 - d50  
R = 1,5d pro d63 - d315  
vyrobena z trubky

#### oblouk 90° lepení

d mm	PN bar	m kg	objednací kód	cena Kč	cena EUR	balení [ks]		sk
						MB	VB	
32	10		32 105 032	59,70	2,49		350	E
40	10		32 105 040	80,30	3,35		200	E
50	10		32 105 050	119,40	4,98		100	E
63	10		32 105 063	183,30	7,64		60	E
75	10		32 105 075	243,00	10,13		35	E
90	10		32 105 090	471,50	19,65		20	E
110	12,5		32 105 110	829,80	34,58		10	E
125	12,5		32 105 125	1 058,40	44,10		6	E
140	12,5		32 105 140	2 781,80	115,91		5	E
160	12,5		32 105 160	2 044,60	85,19		4	E
200	12,5		32 105 200	3 866,90	161,12		1	E
225	12,5		32 105 225	5 067,30	211,14		1	E
250	12,5		32 105 250	6 381,00	265,88		1	E
280	12,5		32 105 280	10 134,70	422,28		1	E
315	12,5		32 105 315	16 273,60	678,07		1	E
40	16		32 106 040	84,20	3,51		100	E
50	16		32 106 050	128,10	5,34		80	E
63	16		32 106 063	230,60	9,61		45	E
75	16		32 106 075	325,30	13,55		25	E
90	16		32 106 090	601,30	25,05		15	E

## PVC-UH tvarovky na lepení, závitové a přechodové

### 32 115/116



R = 1,8d pro d32 - d50  
R = 1,5d pro d63 - d315  
vyrobeno z trubky

#### oblouk 45° lepení

d mm	PN bar	m kg	objednáací kód	cena Kč	cena EUR	balení [ks]		sk
						MB	VB	
32	10		32 115 032	53,50	2,23		300	E
40	10		32 115 040	70,00	2,92		150	E
50	10		32 115 050	107,10	4,46		150	E
63	10		32 115 063	162,70	6,78		90	E
75	10		32 115 075	193,60	8,07		50	E
90	10		32 115 090	395,30	16,47		30	E
110	12,5		32 115 110	669,20	27,88		15	E
125	12,5		32 115 125	903,90	37,66		10	E
140	12,5		32 115 140	1 492,80	62,20		7	E
160	12,5		32 115 160	1 752,30	73,01		5	E
200	12,5		32 115 200	3 197,70	133,24		1	E
225	12,5		32 115 225	4 192,20	174,68		1	E
250	12,5		32 115 250	5 306,20	221,09		1	E
280	12,5		32 115 280	7 672,00	319,67		1	E
315	12,5		32 115 315	10 035,80	418,16		1	E
32	16		32 116 032	63,10	2,63		350	E
40	16		32 116 040	71,90	3,00		150	E
50	16		32 116 050	108,70	4,53		125	E
63	16		32 116 063	161,70	6,74		60	E
75	16		32 116 075	222,70	9,28		40	E
90	16		32 116 090	434,90	18,12		20	E

### 32 117



R = 2,5d  
vyrobeno z trubky

#### oblouk 30° lepení

d mm	PN bar	m kg	objednáací kód	cena Kč	cena EUR	balení [ks]		sk
						MB	VB	
90	10		32 117 090	385,10	16,05		30	E
110	12,5		32 117 110	669,20	27,88		15	E
125	12,5		32 117 125	903,90	37,66		10	E
140	12,5		32 117 140	1 494,90	62,29		7	E
160	12,5		32 117 160	1 742,00	72,58		5	E
200	12,5		32 117 200	3 195,70	133,15		1	E
225	12,5		32 117 225	4 192,20	174,68		1	E
250	12,5		32 117 250	5 304,10	221,00		1	E
280	12,5		32 117 280	8 762,60	365,11		1	E
315	12,5		32 117 315	10 035,80	418,16		1	E

### 32 119



vyrobeno z trubky

#### oblouk 22,5° lepení

d mm	PN bar	m kg	objednáací kód	cena Kč	cena EUR	balení [ks]		sk
						MB	VB	
90	10		32 119 090	395,30	16,47		30	E
110	12,5		32 119 110	669,20	27,88		15	E
125	12,5		32 119 125	903,90	37,66		10	E
140	12,5		32 119 140	1 494,90	62,29		7	E
160	12,5		32 119 160	1 742,00	72,58		5	E
200	12,5		32 119 200	3 531,40	147,14		1	E

### 32 114



vyrobeno z trubky

#### oblouk 15° lepení

d mm	PN bar	m kg	objednáací kód	cena Kč	cena EUR	balení [ks]		sk
						MB	VB	
90	10		32 114 090	224,40	9,35		25	E
110	12,5		32 114 110	378,90	15,79		15	E
125	12,5		32 114 125	488,00	20,33		10	E
140	12,5		32 114 140	790,70	32,95		7	E
160	12,5		32 114 160	986,30	41,10		6	E
200	12,5		32 114 200	1 952,00	81,33		36	E
225	12,5		32 114 225	2 242,30	93,43		1	E
250	12,5		32 114 250	2 499,70	104,15		1	E
280	12,5		32 114 280	3 030,90	126,29		1	E
315	12,5		32 114 315	3 689,80	153,74		8	E



## PVC-UH tvarovky na lepení, závitové a přechodové

### 32 TII



#### T - kus 90° lepení

d mm	PN bar	m kg	objednáací kód	cena Kč	cena EUR	balení [ks]		sk
						MB	VB	
12	16		32 TII 012	25,70	1,07		250	E
16	16	0,012	32 TII 016	16,60	0,66		300	A
20	16	0,020	32 TII 020	16,90	0,68		400	A
25	16	0,034	32 TII 025	20,50	0,82		200	A
32	16	0,054	32 TII 032	29,90	1,20		130	A
40	16	0,127	32 TII 040	48,40	1,94		70	A
50	16	0,184	32 TII 050	56,40	2,26		80	A
63	16	0,315	32 TII 063	86,30	3,45		50	A
75	16	0,139	32 TII 075	173,30	6,93		32	A
90	16	0,830	32 TII 090	242,30	9,69		20	A
110	16	1,330	32 TII 110	350,00	14,00		10	A
125	16	1,960	32 TII 125	778,10	31,12		6	A
140	16	2,730	32 TII 140	1 076,40	43,06		4	A
160	16	4,350	32 TII 160	1 276,60	51,06		3	A
180	10	6,180	32 TII 180	3 899,40	155,98		3	A
200	10	6,540	32 TII 200	2 370,50	94,82		2	A
225	10	9,800	32 TII 225	2 653,60	106,14		1	A
250	10	13,250	32 TII 250	5 544,90	221,80		1	A
280	10	17,840	32 TII 280	7 907,00	316,28		1	A
315	10	25,300	32 TII 315	10 267,80	410,71		1	A

### 32 TIF



#### T - kus 90° závitový

G inch	PN bar	m kg	objednáací kód	cena Kč	cena EUR	balení [ks]		sk
						MB	VB	
3/8"	16	0,018	32 TIF 038	25,10	1,00		700	A
1/2"	16	0,029	32 TIF 012	25,80	1,03		400	A
3/4"	16	0,050	32 TIF 034	34,10	1,36		220	A
1"	16	0,076	32 TIF 100	42,50	1,70		120	A
1 1/4"	16	0,122	32 TIF 114	59,30	2,37		70	A
1 1/2"	16	0,240	32 TIF 112	89,90	3,60		80	A
2"	16	0,411	32 TIF 200	132,50	5,30		45	A
2 1/2"	16	0,540	32 TIF 212	331,20	13,25		30	A
3"	16	0,915	32 TIF 300	426,70	17,07		18	A
4"	16	1,310	32 TIF 400	766,90	30,68		10	A

### 32 TIP



#### T - kus 90° lepení x vnitřní závit x lepení

d x G x d mm x inch x mm	PN bar	m kg	objednáací kód	cena Kč	cena EUR	balení [ks]		sk
						MB	VB	
16 x 3/8" x 16	16	0,017	32 TIP 016 038	33,90	1,36		300	A
20 x 1/2" x 20	16	0,028	32 TIP 020 012	28,60	1,14		400	A
25 x 3/4" x 25	16	0,046	32 TIP 025 034	35,60	1,42		220	A
32 x 1" x 32	16	0,074	32 TIP 032 100	46,70	1,87		120	A
40 x 1 1/4" x 40	16	0,120	32 TIP 040 114	64,10	2,56		70	A
50 x 1 1/2" x 50	16	0,195	32 TIP 050 112	96,20	3,85		80	A
63 x 2" x 63	16	0,335	32 TIP 063 200	157,60	6,30		45	A
75 x 2 1/2" x 75	16	0,505	32 TIP 075 212	301,20	12,05		30	A
90 x 3" x 90	16	0,790	32 TIP 090 300	432,30	17,29		18	A
110 x 4" x 110	16	1,325	32 TIP 110 400	712,60	28,50		10	A

### 32 TTP



#### T - kus 90° se zpev. kroužkem lep. x vnitřní závit x lep.

d x G x d mm x inch x mm	PN bar	m kg	objednáací kód	cena Kč	cena EUR	balení [ks]		sk
						MB	VB	
16 x 3/8" x 16	16	0,018	32 TTP 016 038	62,60	2,50		700	A
20 x 1/2" x 20	16	0,030	32 TTP 020 012	43,90	1,76		400	A
25 x 3/4" x 25	16	0,048	32 TTP 025 034	55,10	2,20		220	A
32 x 1" x 32	16	0,076	32 TTP 032 100	65,50	2,62		130	A
40 x 1 1/4" x 40	16	0,124	32 TTP 040 114	96,90	3,88		70	A
50 x 1 1/2" x 50	16	0,200	32 TTP 050 112	135,30	5,41		80	A
63 x 2" x 63	16	0,365	32 TTP 063 200	190,40	7,62		45	A

## PVC-UH tvarovky na lepení, závitové a přechodové

### 32 047



#### T - kus 45° lepení

d mm	PN bar	m kg	objednáací kód	cena Kč	cena EUR	balení [ks]		sk
						MB	VB	
10	10		32 047 010	97,00	4,04			E
12	10		32 047 012	97,00	4,04			E
16	10		32 047 016	108,70	4,53			E
20	10		32 047 020	58,60	2,34			A
25	16		32 047 025	64,50	2,58		70	A
32	16		32 047 032	73,90	2,96		90	A
40	16		32 047 040	98,40	3,94		50	A
50	16		32 047 050	129,00	5,16		35	A
63	10		32 047 063	176,40	7,06		18	A
75	10		32 047 075	585,50	23,42		16	B
90	10		32 047 090	875,50	35,02		9	B
110	10		32 047 110	1 794,00	71,76		3	B
125	10		32 047 125	1 949,90	81,25		3	E
140	10		32 047 140	3 078,30	128,26		2	E
160	10		32 047 160	4 289,00	178,71		2	E
200	6		32 047 200	8 417,40	350,73		1	E
225	6		32 047 225	13 791,50	574,65		1	E
250	6		32 047 250	17 104,50	712,69		1	E

### 32 CRI



#### kříž 90° lepení

d mm	PN bar	m kg	objednáací kód	cena Kč	cena EUR	balení [ks]		sk
						MB	VB	
16	16		32 CRI 016	52,50	2,19		150	E
20	16	0,030	32 CRI 020	43,90	1,76		200	A
25	16	0,060	32 CRI 025	55,10	2,20		80	A
32	16	0,110	32 CRI 032	62,80	2,51		100	A
40	16	0,180	32 CRI 040	94,90	3,80		60	A
50	16	0,270	32 CRI 050	117,80	4,71		35	A
63	16	0,510	32 CRI 063	174,30	6,97		20	A
75	16	0,750	32 CRI 075	612,80	24,51		10	A
90	16	0,933	32 CRI 090	808,80	32,35		12	A
110	16	1,588	32 CRI 110	1 163,70	46,55		7	A

### 32 049



#### Y-kus lepení

d mm	PN bar	m kg	objednáací kód	cena Kč	cena EUR	balení [ks]		sk
						MB	VB	
50	16		32 049 050	121,50	5,06		70	E
63	16		32 049 063	158,60	6,61		35	E
75	16		32 049 075	389,20	16,22		20	E



d mm	PN bar	m kg	objednáací kód	cena Kč	cena EUR	balení [ks]		sk
						MB	VB	
50	16		32 049 051	150,30	6,26		55	E
63	10		32 049 064	183,30	7,64		25	E

## PVC-UH tvarovky na lepení, závitové a přechodové

### 32 TRI



### T - kus 90° redukováný lepení

d x d x d mm	PN bar	m kg	objednací kód	cena Kč	cena EUR	balení [ks]		sk
						MB	VB	
20 x 16 x 20	16	0,016	32 TRI 020 016	17,40	0,70		180	A
25 x 16 x 25	16	0,041	32 TRI 025 016	21,60	0,86		250	A
25 x 20 x 25	16	0,042	32 TRI 025 020	21,60	0,86		250	A
32 x 16 x 32	16	0,068	32 TRI 032 016	28,60	1,14		150	A
32 x 20 x 32	16	0,066	32 TRI 032 020	28,60	1,14		150	A
32 x 25 x 32	16	0,070	32 TRI 032 025	28,60	1,14		150	A
40 x 20 x 40	16	0,105	32 TRI 040 020	46,70	1,87		70	A
40 x 25 x 40	16	0,111	32 TRI 040 025	46,70	1,87		70	A
40 x 32 x 40	16	0,112	32 TRI 040 032	46,70	1,87		70	A
50 x 20 x 50	16	0,156	32 TRI 050 020	65,50	2,62		90	A
50 x 25 x 50	16	0,162	32 TRI 050 025	65,50	2,62		90	A
50 x 32 x 50	16	0,162	32 TRI 050 032	65,50	2,62		90	A
50 x 40 x 50	16	0,168	32 TRI 050 040	65,50	2,62		90	A
63 x 20 x 63	16	0,268	32 TRI 063 020	101,10	4,04		60	A
63 x 25 x 63	16	0,270	32 TRI 063 025	101,10	4,04		60	A
63 x 32 x 63	16	0,274	32 TRI 063 032	101,10	4,04		50	A
63 x 40 x 63	16	0,277	32 TRI 063 040	101,10	4,04		50	A
65 x 50 x 63	16	0,278	32 TRI 063 050	101,10	4,04		50	A
75 x 32 x 75	16	0,463	32 TRI 075 032	187,60	7,50		35	A
75 x 40 x 75	16	0,465	32 TRI 075 040	187,60	7,50		30	A
75 x 50 x 75	16	0,464	32 TRI 075 050	187,60	7,50		30	A
75 x 63 x 75	16	0,478	32 TRI 075 063	187,60	7,50		30	A
90 x 40 x 90	16	0,702	32 TRI 090 040	274,00	10,96		20	A
90 x 50 x 90	16	0,703	32 TRI 090 050	274,00	10,96		20	A
90 x 63 x 90	16	0,713	32 TRI 090 063	274,00	10,96		20	A
90 x 75 x 90	16	0,731	32 TRI 090 075	274,00	10,96		20	A
110 x 50 x 110	16	1,245	32 TRI 110 050	426,00	17,04		12	A
110 x 63 x 110	16	1,250	32 TRI 110 063	426,00	17,04		12	A
110 x 75 x 110	16	1,255	32 TRI 110 075	426,00	17,04		10	A
110 x 90 x 110	16	1,297	32 TRI 110 090	426,00	17,04		10	A
125 x 50 x 125	16	1,930	32 TRI 125 050	898,50	37,44			E
125 x 63 x 125	16		32 TRI 125 063	1 068,10	42,72			A
125 x 75 x 125	16	1,980	32 TRI 125 075	1 068,10	42,72		8	A
125 x 90 x 125	16	2,020	32 TRI 125 090	1 068,10	42,72		8	A
125 x 110 x 125	16	2,060	32 TRI 125 110	1 068,10	42,72		8	A
140 x 90 x 140	16	2,490	32 TRI 140 090	1 410,50	56,42		4	A
140 x 110 x 140	16	2,530	32 TRI 140 110	1 410,50	56,42		4	A
140 x 125 x 140	16	2,590	32 TRI 140 125	1 410,50	56,42		4	A
160 x 90 x 160	16	3,790	32 TRI 160 090	1 560,30	62,41		3	A
160 x 110 x 160	16	3,840	32 TRI 160 110	1 560,30	62,41		3	A
160 x 125 x 160	16	3,890	32 TRI 160 125	1 560,30	62,41		3	A
160 x 140 x 160	16	3,940	32 TRI 160 140	1 560,30	62,41		3	A
200 x 110 x 200	10		32 TRI 200 110	3 599,40	143,98		1	E
200 x 160 x 200	10		32 TRI 200 160	4 268,10	170,72		2	E
250 x 110 x 250	10		32 TRI 250 110	6 170,30	246,81			A
250 x 160 x 250	10		32 TRI 250 160	6 170,30	246,81		1	A
250 x 200 x 250	10		32 TRI 250 200	6 170,30	246,81		1	A
315 x 160 x 315	8		32 TRI 315 160	11 890,50	475,62		1	D
315 x 250 x 315	8		32 TRI 315 250	11 890,50	475,62		1	D

## PVC-UH tvarovky na lepení, závitové a přechodové

### 32 130/131

#### průchodka



d1 x d2 x d3 mm x mm/inch x inch	PN bar	m kg	objednáací kód	cena Kč	cena EUR	balení [ks]		sk
						MB	VB	
20 x 25 x 3/4"			32 130 020	257,40	10,73		50	E
25 x 32 x 1"			32 130 025	280,00	11,67		50	E
32 x 40 x 1 1/4"			32 130 032	304,70	12,70		50	E
40 x 50 x 1 3/4"			32 130 040	372,70	15,53		50	E
50 x 63 x 2"			32 130 050	422,10	17,59		45	E
50 x 63 x 2 1/4"			32 130 051	422,10	17,59		45	E
63 x 75 x 2 1/2"			32 130 063	833,90	34,75		24	E
75 x 90 x 3"			32 130 075	998,60	41,61		21	E
90 x 110 x M113			32 130 090	1 369,30	57,05		10	E
110 x 125 x M133			32 130 110	1 667,80	69,49		10	E
20 x 3/4" x 3/4"			32 131 020	259,40	10,81		50	E
25 x 1" x 1"			32 131 025	280,00	11,67		50	E
32 x 1 1/4" x 1 1/4"			32 131 032	310,90	12,95		50	E
40 x 1 1/2" x 1 3/4"			32 131 040	431,20	17,97		50	E
50 x 2" x 2"			32 131 050	422,10	17,59		45	E
50 x 2" x 2 1/4"			32 131 051	488,60	20,36		45	E
63 x 2 1/2" x 2 1/2"			32 131 063	833,90	34,75		24	E
75 x 3" x 3"			32 131 075	1 026,00	42,75		21	E
90 x 4" x M113			32 131 090	1 165,00	48,54		10	E



### 32 132

#### průchodka s upínací maticí



d x G mm x inch	PN bar	m kg	objednáací kód	cena Kč	cena EUR	balení [ks]		sk
						MB	VB	
20 x 3/4"			32 132 020	179,10	7,46		100	E
25 x 1"			32 132 025	195,60	8,15		100	E
32 x 1 1/4"			32 132 032	203,90	8,50		10	E
40 x 1 3/4"			32 132 040	226,50	9,44		80	E
50 x 2"			32 132 050	442,70	18,45		45	E
63 x 2 1/2"			32 132 063	520,90	21,70		30	E

### 32 133

#### průchodka



d x G mm x inch	PN bar	m kg	objednáací kód	cena Kč	cena EUR	balení [ks]		sk
						MB	VB	
25 x 1"		0,068	32 133 025	104,50	4,35		30	C
32 x 1 1/4"		0,119	32 133 032	111,70	4,65		30	C
40 x 2"		0,275	32 133 040	178,20	7,43		16	C
50 x 2"		0,188	32 133 050	197,20	8,22		16	C
63 x 2 1/2"		0,263	32 133 063	304,10	12,67			C
75 x 3"			32 133 075	459,20	19,13			E

### 32 134

#### průchodka do dna nádrže



d x G mm x inch	PN bar	m kg	objednáací kód	cena Kč	cena EUR	balení [ks]		sk
						MB	VB	
16 x 3/4"			32 134 016	434,00	18,08			E
20 x 1"			32 134 020	609,00	25,38			E
25 x 1 1/4"			32 134 025	656,00	27,33		75	E
32 x 1 1/2"			32 134 032	555,00	23,13			E
40 x 2"			32 134 040	350,70	14,61		45	E
50 x 2 1/4"			32 134 050	966,00	40,25			E
63 x 2 3/4"			32 134 063	1 252,00	52,17			E

## PVC-UH tvarovky na lepení, závitové a přechodové

### 32 MAI



#### spojka lepení

d mm	PN bar	m kg	objednací kód	cena Kč	cena EUR	balení [ks]		sk
						MB	VB	
12	16		32 MAI 012	17,40	0,73		300	B
16	16	0,006	32 MAI 016	11,80	0,47		500	A
20	16	0,010	32 MAI 020	11,80	0,47		900	A
25	16	0,016	32 MAI 025	13,70	0,55		500	A
32	16	0,027	32 MAI 032	14,40	0,58		250	A
40	16	0,043	32 MAI 040	23,40	0,94		180	A
50	16	0,078	32 MAI 050	25,80	1,03		100	A
63	16	0,121	32 MAI 063	34,10	1,36		100	A
75	16	0,226	32 MAI 075	97,70	3,91		70	A
90	16	0,365	32 MAI 090	152,30	6,09		45	A
110	16	0,625	32 MAI 110	178,40	7,14		27	A
125	16	0,840	32 MAI 125	355,60	14,22		20	A
140	16	1,100	32 MAI 140	421,10	16,84		10	A
160	16	1,380	32 MAI 160	497,10	19,88		6	A
200	16	3,810	32 MAI 200	1 197,10	47,88		3	A
225	10	4,755	32 MAI 225	1 370,70	54,83		2	A
250	10	5,760	32 MAI 250	2 546,90	101,88		2	A
280	10	7,630	32 MAI 280	3 286,00	131,44		2	A
315	10	9,780	32 MAI 315	3 901,60	156,06		1	A
355	6	8,826	32 MAI 355	5 346,90	213,88			A
400	6	13,000	32 MAI 400	5 878,80	235,15			A

### 32 MAF



#### spojka závitová

G inch	PN bar	m kg	objednací kód	cena Kč	cena EUR	balení [ks]		sk
						MB	VB	
3/8"	16	0,008	32 MAF 038	20,90	0,84		1300	A
1/2"	16	0,018	32 MAF 012	23,00	0,92		700	A
3/4"	16	0,025	32 MAF 034	25,80	1,03		450	A
1"	16	0,045	32 MAF 100	28,60	1,14		250	A
1 1/4"	16	0,063	32 MAF 114	41,10	1,64		150	A
1 1/2"	16	0,070	32 MAF 112	59,30	2,37		100	A
2"	16	0,125	32 MAF 200	79,40	3,18		50	A
2 1/2"	16	0,188	32 MAF 212	228,70	9,15		80	A
3"	16	0,290	32 MAF 300	279,60	11,18		60	A
4"	16	0,460	32 MAF 400	396,70	15,87		35	A
6"	16	1,400	32 MAF 600	758,00	30,32			B

### 32 MAP



#### spojka lepení x vnitřní závit

d x G mm x inch	PN bar	m kg	objednací kód	cena Kč	cena EUR	balení [ks]		sk
						MB	VB	
12 x 1/4"	16		32 MAP 012 014	36,00	1,50		100	E
16 x 3/8"	16	0,009	32 MAP 016 038	21,60	0,86		1400	A
20 x 1/2"	16	0,017	32 MAP 020 012	23,70	0,95		700	A
25 x 3/4"	16	0,024	32 MAP 025 034	25,10	1,00		450	A
32 x 1"	16	0,042	32 MAP 032 100	28,60	1,14		250	A
40 x 1 1/4"	16	0,060	32 MAP 040 114	41,10	1,64		150	A
50 x 1 1/2"	16	0,087	32 MAP 050 112	62,80	2,51		100	A
63 x 2"	16	0,134	32 MAP 063 200	82,30	3,29		50	A
75 x 2 1/2"	16	0,215	32 MAP 075 212	246,80	9,87		75	A
90 x 3"	16	0,340	32 MAP 090 300	279,60	11,18		40	A
110 x 4"	16	0,550	32 MAP 110 400	405,10	16,20		25	A

## PVC-UH tvarovky na lepení, závitové a přechodové

### 32 MMP



#### spojka se zpev. kroužkem lepení x vnitřní závit

d x G mm x inch	PN bar	m kg	objednací kód	cena Kč	cena EUR	balení [ks]		sk
						MB	VB	
12 x 1/4"	16	0,010	32 MMP 012 014	79,50	3,31			E
16 x 3/8"	16	0,010	32 MMP 016 038	83,70	3,35		1500	A
20 x 1/2"	16	0,019	32 MMP 020 012	38,40	1,54		350	A
25 x 3/4"	16	0,026	32 MMP 025 034	42,50	1,70		450	A
32 x 1"	16	0,044	32 MMP 032 100	49,60	1,98		250	A
40 x 1 1/4"	16	0,063	32 MMP 040 114	62,00	2,48		150	A
50 x 1 1/2"	16	0,092	32 MMP 050 112	82,30	3,29		100	A
63 x 2"	16	0,140	32 MMP 063 200	98,40	3,94		50	A

### 32 MFP



#### spojka vnitřní/vnější lepení x vnitřní závit DOPRODEJ

d1/d2 x G mm x inch	PN bar	m kg	objednací kód	cena Kč	cena EUR	balení [ks]		sk
						MB	VB	
20/25 x 1/2"	16	0,020	32 MFP 020 012	16,20	0,65			Z
25/32 x 3/4"	16	0,032	32 MFP 025 034	18,50	0,74			Z

### 32 AFP



#### přechod vnější lepení x vnitřní závit

d x G mm x inch	PN bar	m kg	objednací kód	cena Kč	cena EUR	balení [ks]		sk
						MB	VB	
16 x 3/8"	16	0,016	32 AFP 016 038	33,40	1,34		600	A
20 x 1/2"	16	0,019	32 AFP 020 012	37,50	1,50		800	A
20 x 3/4"	16	0,024	32 AFP 020 034	41,10	1,64		600	A
25 x 1/2"	16	0,020	32 AFP 025 012	41,10	1,64		700	A
25 x 3/4"	16	0,026	32 AFP 025 034	43,40	1,74		500	A
25 x 1"	16	0,039	32 AFP 025 100	45,10	1,80		300	A
32 x 3/4"	16	0,032	32 AFP 032 034	45,10	1,80		250	A
32 x 1"	16	0,042	32 AFP 032 100	51,20	2,05		250	A
40 x 1"	16	0,050	32 AFP 040 100	53,80	2,15		220	A
40 x 1 1/4"	16	0,065	32 AFP 040 114	56,50	2,26		150	A
50 x 1 1/4"	16	0,070	32 AFP 050 114	63,50	2,54		120	A
50 x 1 1/2"	16	0,073	32 AFP 050 112	69,00	2,76		100	A
50 x 2"	16	0,080	32 AFP 050 200	95,10	3,80		100	A
63 x 1 1/2"	16	0,148	32 AFP 063 112	123,40	4,94		80	A
63 x 2"	16	0,140	32 AFP 063 200	118,60	4,74		60	A
75 x 2"	16	0,175	32 AFP 075 200	152,30	6,09		45	A
75 x 2 1/2"	16	0,225	32 AFP 075 212	157,60	6,30		35	A
75 x 3"	16	0,295	32 AFP 075 300	160,40	6,42		35	A
90 x 2 1/2"	16	0,275	32 AFP 090 212	218,90	8,76		25	A
90 x 3"	16	0,310	32 AFP 090 300	227,30	9,09		40	A
90 x 4"	16	0,450	32 AFP 090 400	234,30	9,37		35	A
110 x 3"	16	0,440	32 AFP 110 300	294,30	11,77		35	A
110 x 4"	16	0,480	32 AFP 110 400	306,80	12,27		30	A

### 32 AAP



#### přechod se zpev. kroužkem vnější lepení x vnitřní závit

d x G mm x inch	PN bar	m kg	objednací kód	cena Kč	cena EUR	balení [ks]		sk
						MB	VB	
16 x 3/8"	16	0,011	32 AAP 016 038	37,10	1,55			B
20 x 1/2"	16	0,018	32 AAP 020 012	49,10	1,96		750	A
20 x 3/4"	16	0,020	32 AAP 020 034	55,50	2,22		300	A
25 x 1/2"	16	0,025	32 AAP 025 012	55,50	2,22		700	A
25 x 3/4"	16	0,022	32 AAP 025 034	62,40	2,50		450	A
25 x 1"	16	0,028	32 AAP 025 100	64,20	2,57		400	A
32 x 3/4"	16	0,041	32 AAP 032 034	64,20	2,57		400	A
32 x 1"	16	0,034	32 AAP 032 100	73,30	2,93		270	A
40 x 1"	16	0,047	32 AAP 040 100	73,30	2,93		220	A
40 x 1 1/4"	16	0,053	32 AAP 040 114	80,80	3,23		150	A
50 x 1 1/4"	16	0,068	32 AAP 050 114	85,60	3,42		140	A
50 x 1 1/2"	16	0,074	32 AAP 050 112	96,20	3,85		100	A
50 x 2"	16	0,077	32 AAP 050 200	129,00	5,16		100	A
63 x 2"	16	0,083	32 AAP 063 200	145,60	5,82		60	A

## PVC-UH tvarovky na lepení, závitové a přechodové

### 32 AMP



#### přechod vnitřní/vnější lepení x vnější závit

d1/d2 x G mm x inch	PN bar	m kg	objednací kód	cena Kč	cena EUR	balení [ks]		sk
						MB	VB	
12/16 x 1/4"	16		32 AMP 012 014	18,50	0,77		250	E
-16 x 3/8"	16	0,009	32 AMP 012 038	18,90	0,76		1000	A
16/- x 1/4"	16		32 AMP 016 014	17,20	0,72			E
16/20 x 3/8"	16	0,010	32 AMP 016 038	18,90	0,76		500	A
16/20 x 1/2"	16	0,011	32 AMP 016 012	18,90	0,76		450	A
20/25 x 3/8"	16	0,014	32 AMP 020 038	20,10	0,80		700	A
20/25 x 1/2"	16	0,014	32 AMP 020 012	19,60	0,78		700	A
20/25 x 3/4"	16	0,018	32 AMP 020 034	19,60	0,78		700	A
25/32 x 1/2"	16	0,024	32 AMP 025 012	20,90	0,84		450	A
25/32 x 3/4"	16	0,026	32 AMP 025 034	20,90	0,84		400	A
25/32 x 1"	16	0,029	32 AMP 025 100	20,90	0,84		400	A
32/40 x 3/4"	16	0,036	32 AMP 032 034	25,80	1,03		280	A
32/40 x 1"	16	0,040	32 AMP 032 100	25,80	1,03		250	A
32/40 x 1 1/4"	16	0,045	32 AMP 032 114	25,80	1,03		200	A
40/50 x 1"	16	0,068	32 AMP 040 100	36,30	1,45		130	A
40/50 x 1 1/4"	16	0,073	32 AMP 040 114	36,30	1,45		130	A
40/50 x 1 1/2"	16	0,076	32 AMP 040 112	36,30	1,45		140	A
50/63 x 1 1/4"	16	0,110	32 AMP 050 114	55,10	2,20		100	A
50/63 x 1 1/2"	16	0,113	32 AMP 050 112	55,10	2,20		80	A
50/63 x 2"	16	0,120	32 AMP 050 200	55,10	2,20		75	A
63/75 x 1 1/2"	16	0,160	32 AMP 063 112	64,10	2,56		70	A
63/75 x 2"	16	0,150	32 AMP 063 200	64,10	2,56		60	A
63/75 x 2 1/2"	16	0,170	32 AMP 063 212	64,10	2,56		45	A
75/90 x 2"	16	0,268	32 AMP 075 200	193,80	7,75		45	A
75/90 x 2 1/2"	16	0,268	32 AMP 075 212	193,80	7,75		45	A
75/90 x 3"	16	0,280	32 AMP 075 300	193,80	7,75		25	A
90/110 x 2"	16	0,485	32 AMP 090 200	---	---		20	-
90/110 x 2 1/2"	16	0,460	32 AMP 090 212	232,80	9,31		20	A
90/110 x 3"	16	0,476	32 AMP 090 300	232,80	9,31		45	A
90/110 x 4"	16	0,485	32 AMP 090 400	232,80	9,31		30	A
110/125 x 3"	16	0,446	32 AMP 110 300	350,70	14,03		35	A
110/125 x 4"	16	0,446	32 AMP 110 400	350,70	14,03		30	A
110/125 x 5"	16	0,480	32 AMP 110 500	228,00	9,12		30	D
* 125/140 x 5"	16	0,500	32 AMP 125 500	378,00	15,75			D

\* mechanicky obroben, bez osmihranu

### 32 067



#### vsuvka na lepení

d mm	PN bar	m kg	objednací kód	cena Kč	cena EUR	balení [ks]		sk
						MB	VB	
20	16		32 067 020	18,30	0,73			A
25	16		32 067 025	16,90	0,68			A
32	16		32 067 032	18,50	0,74			A
40	16		32 067 040	35,30	1,41			A
50	16		32 067 050	49,80	1,99			A
63	16		32 067 063	56,90	2,28			A
75	16		32 067 075	180,00	7,50			H
90	16		32 067 090	246,00	10,25			H
110	16		32 067 110	358,00	14,92			H
160	16		32 067 160	969,00	40,38			H

### 32 NIF



#### vsuvka závitová

G inch	PN bar	m kg	objednací kód	cena Kč	cena EUR	balení [ks]		sk
						MB	VB	
3/8"	16	0,009	32 NIF 038	18,70	0,75		1000	A
1/2"	16	0,011	32 NIF 012	20,10	0,80		450	A
3/4"	16	0,018	32 NIF 034	23,70	0,95		700	A
1"	16	0,028	32 NIF 100	28,70	1,15		400	A
1 1/4"	16	0,046	32 NIF 114	37,50	1,50		200	A
1 1/2"	16	0,050	32 NIF 112	44,30	1,77		150	A
2"	16	0,090	32 NIF 200	58,80	2,35		200	A
2 1/2"	16	0,142	32 NIF 212	161,30	6,45		110	A
3"	16	0,221	32 NIF 300	221,40	8,86		70	A
4"	16	0,345	32 NIF 400	320,00	12,80		35	A

## PVC-UH tvarovky na lepení, závitové a přechodové

### 32 NRF



#### vsuvka závitová redukováná

G x G inch	PN bar	m kg	objednací kód	cena Kč	cena EUR	balení [ks]		sk
						MB	VB	
1/2" x 3/8"	16	0,011	32 NRF 012 038	25,80	1,03		650	A
3/4" x 1/2"	16	0,017	32 NRF 034 012	28,60	1,14		350	A
1" x 3/4"	16	0,026	32 NRF 100 034	37,00	1,48		400	A
1 1/4" x 1"	16	0,042	32 NRF 114 100	46,70	1,87		270	A
1 1/2" x 1 1/4"	16	0,048	32 NRF 112 114	55,80	2,23		150	A
2" x 1 1/2"	16	0,081	32 NRF 200 112	84,40	3,38		100	A
2 1/2" x 2"	16	0,138	32 NRF 212 200	163,10	6,52		80	A
3" x 2 1/2"	16	0,208	32 NRF 300 212	198,70	7,95		70	A
4" x 3"	16	0,339	32 NRF 400 300	307,50	12,30		24	A

### 32 MRI



#### redukcce dlouhá

d x d mm	PN bar	m kg	objednací kód	cena Kč	cena EUR	balení [ks]		sk
						MB	VB	
20 x 16	16	0,014	32 MRI 020 016	11,80	0,47		1000	A
25 x 20	16	0,022	32 MRI 025 020	14,00	0,56		500	A
32 x 25	16	0,035	32 MRI 032 025	19,60	0,78		300	A
40 x 32	16	0,053	32 MRI 040 032	25,10	1,00		150	A
50 x 40	16	0,081	32 MRI 050 040	34,10	1,36		100	A
63 x 50	16	0,120	32 MRI 063 050	48,10	1,92		60	A
75 x 63	16	0,211	32 MRI 075 063	96,20	3,85		80	A
90 x 75	16	0,350	32 MRI 090 075	154,80	6,19		50	A
110 x 90	16	0,550	32 MRI 110 090	232,80	9,31		35	A
125 x 110	16	0,740	32 MRI 125 110	370,30	14,81		16	A
140 x 110	16	0,970	32 MRI 140 110	465,80	18,63		15	A
140 x 125	16	1,025	32 MRI 140 125	571,00	22,84			A
160 x 110	16	1,220	32 MRI 160 110	780,90	31,24			A
160 x 125	16		32 MRI 160 125	---	---			-
160 x 140	16	1,350	32 MRI 160 140	780,90	31,24			A
200 x 110	10		32 MRI 200 110	1 671,00	69,63			C
200 x 125	10		32 MRI 200 125	1 671,00	69,63			C
200 x 140	10		32 MRI 200 140	1 671,00	69,63			C
200 x 160	10		32 MRI 200 160	1 560,30	62,41			A
225 x 200	10		32 MRI 225 200	1 766,10	70,64			A
250 x 200	10		32 MRI 250 200	3 475,90	139,04			E
250 x 225	10		32 MRI 250 225	3 475,90	139,04			E
315 x 250	10		32 MRI 315 250	4 601,00	184,04			E



## PVC-UH tvarovky na lepení, závitové a přechodové

32 064



### redukce dlouhá vnitřní/vnější x vnitřní lepení

d1/d2 x d3 mm	PN bar	m kg	objednací kód	cena Kč	cena EUR	balení [ks]		sk
						MB	VB	
6/10 x 8	16		32 064 006 008	23,30	0,97		250	E
8/12 x 10	16		32 064 008 010	36,20	1,51			E
12/16 x 8	16		32 064 012 008	28,00	1,17		250	E
12/16 x 10	16		32 064 012 010	23,70	0,99		250	E
16/20 x 10	16		32 064 016 010	32,20	1,34		250	E
16/20 x 12	16		32 064 016 012	26,50	1,10		250	E
20/25 x 16	16		32 064 020 016	21,30	0,85		500	A
20/25 x 20	16		32 064 020 020	21,30	0,85		500	A
25/32 x 16	16		32 064 025 016	23,00	0,92		300	A
25/32 x 20	16		32 064 025 020	23,00	0,92		300	A
25/32 x 25	16		32 064 025 025	23,00	0,92		280	A
32/40 x 16	16		32 064 032 016	32,80	1,37		125	E
32/40 x 20	16		32 064 032 020	29,50	1,18		170	A
32/40 x 25	16		32 064 032 025	29,50	1,18		170	A
32/40 x 32	16		32 064 032 032	29,50	1,18		350	A
40/50 x 20	16		32 064 040 020	36,00	1,50		75	E
40/50 x 25	16		32 064 040 025	39,00	1,56		200	A
40/50 x 32	16		32 064 040 032	39,00	1,56		200	A
50/63 x 25	16		32 064 050 025	37,00	1,48		40	A
50/63 x 32	16		32 064 050 032	37,00	1,48		125	A
50/63 x 40	16		32 064 050 040	37,00	1,48		120	A
50/63 x 50	16		32 064 050 050	56,90	2,28		100	A
63/75 x 32	16		32 064 063 032	144,10	6,00		75	E
63/75 x 40	16		32 064 063 040	72,30	2,89		80	A
63/75 x 50	16		32 064 063 050	72,30	2,89		80	A
63/75 x 63	16		32 064 063 063	108,60	4,34		60	A
75/90 x 40	16		32 064 075 040	144,10	6,00		60	E
75/90 x 50	16		32 064 075 050	135,00	5,63		45	B
75/90 x 63	16		32 064 075 063	175,30	7,01		36	A
75/90 x 75	16		32 064 075 075	208,80	8,35		36	A
90/110 x 50	16		32 064 090 050	248,50	9,94		45	A
90/110 x 63	16		32 064 090 063	248,50	9,94		45	A
90/110 x 75	16		32 064 090 075	248,50	9,94		45	A
90/110 x 90	16		32 064 090 090	285,10	11,40		45	A
110/125 x 50	16		32 064 110 050	216,30	9,01		24	B
110/125 x 63	16		32 064 110 063	376,30	15,05		42	A
110/125 x 75	16		32 064 110 075	375,50	15,02		42	A
110/125 x 90	16		32 064 110 090	376,30	15,05		42	A
110/125 x 110	16		32 064 110 110	398,10	15,92		42	A
125/140 x 75	16		32 064 125 075	357,80	14,91		24	B
125/140 x 90	16		32 064 125 090	596,90	23,88		30	A
125/140 x 110	16		32 064 125 110	596,90	23,88		20	A
125/140 x 125	16		32 064 125 125	596,90	23,88		20	A
140/160 x 110	16		32 064 140 110	940,80	37,63		16	A
140/160 x 125	16		32 064 140 125	1 245,50	49,82		12	A

32 066



### redukce dlouhá vnější x vnitřní lepení

d1 x d2 mm	PN bar	m kg	objednací kód	cena Kč	cena EUR	balení [ks]		sk
						MB	VB	
10 x 6	16		32 066 010 006	63,10	2,629			E
20 x 16	16		32 066 020 016	13,90	0,56			B

## PVC-UH tvarovky na lepení, závitové a přechodové

### 32 065



### PRO-FIT redukce dlouhá vnitřní/vnější x vnitřní/vnější lepení

d1/d2 x d3/d4 mm	PN bar	m g	objednací kód	cena Kč	cena EUR	balení [ks]		sk
						MB	VB	
12/16 x 8/12	16	0,003	32 065 012 008	36,20	1,51			E
12/16 x 10/16	16	0,006	32 065 012 010	36,20	1,51			E
16/20 x 10/16	16	0,005	32 065 016 010	36,20	1,51			E
16/20 x 12/16	16	0,005	32 065 016 012	36,20	1,51			E
20/25 x 12/16	16	0,008	32 065 020 012	37,40	1,56			E
20/25 x 16/20	16	0,008	32 065 020 016	37,40	1,56			E
25/32 x 12/16	16	0,014	32 065 025 012	46,80	1,95			E
25/32 x 16/20	16	0,015	32 065 025 016	46,80	1,95			E
25/32 x 20/25	16	0,017	32 065 025 020	46,80	1,95			E
32/40 x 16/20	16	0,024	32 065 032 016	58,50	2,44			E
32/40 x 20/25	16	0,027	32 065 032 020	58,50	2,44			E
32/40 x 25/32	16	0,032	32 065 032 025	58,50	2,44			E
40/50 x 20/25	16	0,045	32 065 040 020	72,50	3,02			E
40/50 x 25/32	16	0,051	32 065 040 025	72,50	3,02			E
40/50 x 32/40	16	0,058	32 065 040 032	72,50	3,02			E
50/63 x 25/32	16	0,093	32 065 050 025	112,20	4,68			E
50/63 x 32/40	16	0,099	32 065 050 032	112,20	4,68			E
50/63 x 40/50	16	0,111	32 065 050 040	112,20	4,68			E
63/75 x 32/40	16	0,127	32 065 063 032	237,30	9,89			E
63/75 x 40/50	16	0,139	32 065 063 040	237,30	9,89			E
63/75 x 50/63	16	0,167	32 065 063 050	237,30	9,89			E
75/90 x 40/50	16	0,232	32 065 075 040	458,20	19,09			E
75/90 x 50/63	16	0,260	32 065 075 050	458,20	19,09			E
75/90 x 63/75	16	0,275	32 065 075 063	458,20	19,09			E

### 32 MRF



### spojka závitová redukováná

G x G inch	PN bar	m kg	objednací kód	cena Kč	cena EUR	balení [ks]		sk
						MB	VB	
1/2" x 3/8"	16	0,017	32 MRF 012 038	39,70	1,59		450	A
3/4" x 1/2"	16	0,024	32 MRF 034 012	41,10	1,64		500	A
1" x 3/4"	16	0,040	32 MRF 100 034	42,50	1,70		300	A
1 1/4" x 1"	16	0,062	32 MRF 114 100	55,10	2,20		150	A
1 1/2" x 1 1/4"	16	0,072	32 MRF 112 114	76,70	3,07		100	A
2" x 1 1/2"	16	0,115	32 MRF 200 112	109,40	4,38		90	A
2 1/2" x 2"	16	0,128	32 MRF 212 200	234,30	9,37		100	A
3" x 2 1/2"	16	0,286	32 MRF 300 212	282,40	11,30		50	A
4" x 3"	16	0,436	32 MRF 400 300	403,00	16,12		40	A

### manometrový přechod



d x G mm x inch	PN bar	m kg	objednací kód	cena Kč	cena EUR	balení [ks]		sk
						MB	VB	
12 x 1/4"	16	0,010	721 916 204	129,00	5,38			H
16 x 1/2"	16	0,028	721 916 206	129,00	5,38			H

**32 MGF**



**spojka redukována vnější x vnitřní závit**

G x G inch	PN bar	m kg	objednací kód	cena Kč	cena EUR	balení [ks]		sk
						MB	VB	
3/8" x 1/2"	16	0,016	32 MGF 038 012	35,60	1,42		500	A
1/2" x 3/4"	16	0,022	32 MGF 012 034	37,60	1,50		600	A
3/4" x 1"	16	0,037	32 MGF 034 100	39,70	1,59		300	A
1" x 1 1/4"	16	0,059	32 MGF 100 114	42,50	1,70		200	A
1 1/4" x 1 1/2"	16	0,074	32 MGF 114 112	49,60	1,98		150	A
1 1/2" x 2"	16	0,110	32 MGF 112 200	64,10	2,56		90	A
2" x 2 1/2"	16	0,187	32 MGF 200 212	145,70	5,83		100	A
2 1/2" x 3"	16	0,262	32 MGF 212 300	176,40	7,06		75	A
3" x 4"	16	0,350	32 MGF 300 400	301,90	12,08		40	A

**32 RIF**



**spojka redukována vnější x vnitřní závit**

G x G inch	PN bar	m kg	objednací kód	cena Kč	cena EUR	balení [ks]		sk
						MB	VB	
1/2" x 3/8"	16	0,012	32 RIF 012 038	19,60	0,78		1200	A
3/4" x 3/8"	16	0,016	32 RIF 034 038	20,20	0,81		700	A
3/4" x 1/2"	16	0,019	32 RIF 034 012	20,20	0,81		700	A
1" x 3/8"	16	0,024	32 RIF 100 038	25,80	1,03		500	A
1" x 1/2"	16	0,026	32 RIF 100 012	25,80	1,03		500	A
1" x 3/4"	16	0,026	32 RIF 100 034	25,80	1,03		450	A
1 1/4" x 1/2"	16	0,042	32 RIF 114 012	35,60	1,42		250	A
1 1/4" x 3/4"	16	0,043	32 RIF 114 034	35,60	1,42		250	A
1 1/4" x 1"	16	0,046	32 RIF 114 100	35,60	1,42		250	A
1 1/2" x 3/4"	16	0,046	32 RIF 112 034	47,40	1,90		220	A
1 1/2" x 1"	16	0,050	32 RIF 112 100	47,40	1,90		200	A
1 1/2" x 1 1/4"	16	0,060	32 RIF 112 114	47,40	1,90		150	A
2" x 1"	16	0,085	32 RIF 200 100	63,50	2,54		100	A
2" x 1 1/4"	16	0,085	32 RIF 200 114	63,50	2,54		100	A
2" x 1 1/2"	16	0,087	32 RIF 200 112	63,50	2,54		100	A
2 1/2" x 1 1/4"	16	0,140	32 RIF 212 114	129,80	5,19		80	A
2 1/2" x 1 1/2"	16	0,138	32 RIF 212 112	129,80	5,19		60	A
2 1/2" x 2"	16	0,142	32 RIF 212 200	129,80	5,19		60	A
3" x 1 1/2"	16	0,200	32 RIF 300 112	197,40	7,90		30	A
3" x 2"	16	0,205	32 RIF 300 200	197,40	7,90		40	A
3" x 2 1/2"	16	0,215	32 RIF 300 212	197,40	7,90		30	A
4" x 2"	16	0,325	32 RIF 400 200	321,50	12,86		55	A
4" x 2 1/2"	16	0,330	32 RIF 400 212	321,50	12,86		55	A
4" x 3"	16	0,350	32 RIF 400 300	321,50	12,86		45	A

**32 096**



**redukce krátká vnější lepení x vnitřní závit**

d x G mm x inch	PN bar	m kg	objednací kód	cena Kč	cena EUR	balení [ks]		sk
						MB	VB	
16 x 1/4"	16		32 096 016 014	30,90	1,29		250	E
20 x 1/4"	16		32 096 020 014	30,90	1,29		250	E
20 x 3/8"	16		32 096 020 038	35,10	1,46		250	E
25 x 3/8"	16		32 096 025 038	41,20	1,72		250	E
25 x 1/2"	16		32 096 025 012	41,20	1,72		250	E
32 x 1/2"	16		32 096 032 012	45,30	1,89		250	E
32 x 3/4"	16		32 096 032 034	45,30	1,89		250	E
40 x 1/2"	16		32 096 040 012	65,10	2,71		200	E
40 x 3/4"	16		32 096 040 034	61,90	2,58		100	E
40 x 1"	16		32 096 040 100	59,70	2,49		100	E
50 x 1/2"	16		32 096 050 012	77,20	3,22		100	E
50 x 3/4"	16		32 096 050 034	77,20	3,22		100	E
50 x 1"	16		32 096 050 100	77,20	3,22		100	E
50 x 1 1/4"	16		32 096 050 114	77,20	3,22		100	E
63 x 1"	16		32 096 063 100	128,50	5,35		100	E
63 x 1 1/4"	16		32 096 063 114	121,50	5,06		100	E
63 x 1 1/2"	16		32 096 063 112	121,50	5,06		100	E

## PVC-UH tvarovky na lepení, závitové a přechodové

### 32 RCI



### redukcce krátká

d x d mm	PN bar	m kg	objednací kód	cena Kč	cena EUR	balení [ks]		sk
						MB	VB	
16 x 12	16		32 RCI 016 012	14,40	0,60		250	E
20 x 10	16		32 RCI 020 010	14,40	0,60		250	E
20 x 12	16		32 RCI 020 012	14,40	0,60		250	E
20 x 16	16	0,003	32 RCI 020 016	10,40	0,42		1100	A
25 x 16	16	0,008	32 RCI 025 016	11,80	0,47		2200	A
25 x 20	16	0,005	32 RCI 025 020	11,80	0,47		2200	A
32 x 16	16	0,015	32 RCI 032 016	15,30	0,61		1100	A
32 x 20	16	0,015	32 RCI 032 020	15,30	0,61		1100	A
32 x 25	16	0,010	32 RCI 032 025	15,30	0,61		1100	A
40 x 20	16	0,025	32 RCI 040 020	16,70	0,67		600	A
40 x 25	16	0,026	32 RCI 040 025	16,70	0,67		600	A
40 x 32	16	0,016	32 RCI 040 032	16,70	0,67		600	A
50 x 20	16	0,500	32 RCI 050 020	24,00	0,96		300	A
50 x 25	16	0,045	32 RCI 050 025	20,20	0,81		300	A
50 x 32	16	0,042	32 RCI 050 032	20,20	0,81		300	A
50 x 40	16	0,030	32 RCI 050 040	20,20	0,81		300	A
63 x 32	16	0,083	32 RCI 063 032	31,40	1,26		150	A
63 x 40	16	0,078	32 RCI 063 040	31,40	1,26		150	A
63 x 50	16	0,061	32 RCI 063 050	31,40	1,26		150	A
75 x 40	16	0,120	32 RCI 075 040	52,30	2,09		100	A
75 x 50	16	0,122	32 RCI 075 050	52,30	2,09		100	A
75 x 63	16	0,080	32 RCI 075 063	52,30	2,09		100	A
90 x 50	16	0,210	32 RCI 090 050	85,10	3,40		100	A
90 x 63	16	0,195	32 RCI 090 063	85,10	3,40		100	A
90 x 75	16	0,140	32 RCI 090 075	85,10	3,40		100	A
110 x 50	16	0,316	32 RCI 110 050G	280,00	11,67			H
110 x 63	16	0,365	32 RCI 110 063	122,00	4,88		60	A
110 x 75	16	0,370	32 RCI 110 075	122,00	4,88		60	A
110 x 90	16	0,273	32 RCI 110 090	122,00	4,88		60	A
125 x 75	16	0,412	32 RCI 125 075	227,30	9,09		24	A
125 x 90	16	0,450	32 RCI 125 090	227,30	9,09		24	A
125 x 110	16	0,273	32 RCI 125 110	227,30	9,09		24	A
140 x 90	16	0,550	32 RCI 140 090	320,00	12,80		30	A
140 x 110	16	0,510	32 RCI 140 110	320,00	12,80		30	A
140 x 125	16	0,320	32 RCI 140 125	320,00	12,80		30	A
160 x 90	16	1,040	32 RCI 160 090	357,70	14,31		24	A
160 x 110	16	0,820	32 RCI 160 110	357,70	14,31		20	A
160 x 125	16	0,725	32 RCI 160 125	357,70	14,31		20	A
160 x 140	16	0,555	32 RCI 160 140	357,70	14,31			A
180 x 160	16		32 RCI 180 160	392,50	15,70		20	A
200 x 160	16	1,645	32 RCI 200 160	536,90	21,48		10	A
200 x 180	16	0,870	32 RCI 200 180	529,10	21,16			A
225 x 160	10	2,300	32 RCI 225 160	874,30	34,97		7	A
225 x 200	10	1,360	32 RCI 225 200	874,30	34,97		7	A
250 x 160	10	2,784	32 RCI 250 160	1 909,60	76,38		6	A
250 x 200	10	2,700	32 RCI 250 200	1 909,60	76,38		6	A
250 x 225	10	2,100	32 RCI 250 225	1 909,60	76,38		6	A
280 x 225	10		32 RCI 280 225	2 793,00	111,72		4	A
280 x 250	10		32 RCI 280 250	2 793,00	111,72		5	A
315 x 200	10		32 RCI 315 200	2 977,80	119,11		5	A
315 x 225	10	8,100	32 RCI 315 225	2 977,80	119,11		5	A
315 x 250	10	5,080	32 RCI 315 250	2 977,80	119,11		5	A
315 x 280	10		32 RCI 315 280	2 977,80	119,11		5	A

## PVC-UH tvarovky na lepení, závitové a přechodové

### 32 RCF



#### redukce krátká vnější x vnitřní závit

G x G inch	PN bar	m kg	objednáací kód	cena Kč	cena EUR	balení [ks]		sk
						MB	VB	
3/4" x 1/2"	16	0,013	32 RCF 034 012	22,50	0,90		380	A
1" x 3/4"	16	0,019	32 RCF 100 034	28,00	1,12		500	A
1 1/4" x 1"	16	0,034	32 RCF 114 100	43,40	1,74		300	A
1 1/2" x 1 1/4"	16	0,036	32 RCF 112 114	56,50	2,26		270	A
2" x 1 1/2"	16	0,067	32 RCF 200 112	74,70	2,99		160	A
2 1/2" x 2"	16	0,135	32 RCF 212 200	165,80	6,63		90	A
3" x 2 1/2"	16	0,160	32 RCF 300 212	236,20	9,45		50	A
4" x 3"	16	0,380	32 RCF 400 300	376,00	15,04		50	A

### 32 PGI



#### hadicový trn (tulejka)

d1 x d2/d3 mm	PN bar	m kg	objednáací kód	cena Kč	cena EUR	balení [ks]		sk
						MB	VB	
10 x 10	16		32 PGI 010	25,70	1,07		100	E
12 x 12/14	16		32 PGI 012	11,20	0,45		100	A
16 x 16/18	16	0,007	32 PGI 016	19,90	0,80		450	A
20 x 20/22	16	0,013	32 PGI 020	22,20	0,89		300	A
25 x 25/27	16	0,021	32 PGI 025	19,30	0,77		150	A
32 x 32/34	16	0,030	32 PGI 032	22,00	0,88		250	A
40 x 40/42	16	0,055	32 PGI 040	29,50	1,18		280	A
50 x 50/52	16	0,078	32 PGI 050	30,10	1,20		80	A
50 x 32/38	16	0,118	32 PGI 051	66,90	2,79		60	B
63 x 60/64	16	0,142	32 PGI 063	71,40	2,86		50	A

### 32 PGF



#### hadicový trn závitový

G x d1/d2 inch x mm	PN bar	m kg	objednáací kód	cena Kč	cena EUR	balení [ks]		sk
						MB	VB	
1/4" x 12/14	16		32 PGF 014	12,60	0,50		700	A
3/8" x 16/18	16	0,011	32 PGF 038	14,70	0,59		500	A
1/2" x 20/22	16	0,016	32 PGF 012	18,20	0,73		300	A
3/4" x 25/27	16	0,024	32 PGF 034	21,60	0,86		180	A
1" x 32/34	16	0,035	32 PGF 100	25,80	1,03		250	A
1 1/4" x 40/42	16	0,060	32 PGF 114	37,00	1,48		300	A
1 1/2" x 50/52	16	0,074	32 PGF 112	48,10	1,92		100	A
1 1/2" x 32/38	16	0,098	32 PGF 113	72,10	3,00		45	B
2" x 60/64	16	0,126	32 PGF 200	76,00	3,04		50	A

### 32 PGO



#### hadicový trn s převlečnou maticí

G x d1/d2 inch x mm	PN bar	m kg	objednáací kód	cena Kč	cena EUR	balení [ks]		sk
						MB	VB	
3/4" x 16/18	16	0,023	32 PGO 016	45,30	1,81		50	A
1" x 20/22	16	0,032	32 PGO 020	49,60	1,98			A
1 1/4" x 25/27	16	0,049	32 PGO 025	62,00	2,48		50	A
1 1/2" x 32/34	16	0,068	32 PGO 032	83,30	3,33			A
2" x 40/42	16	0,110	32 PGO 040	146,20	6,09		50	E
2 1/4" x 50/53	16	0,145	32 PGO 050	158,20	6,33		50	A
2 3/4" x 60/64	16	0,220	32 PGO 063	137,00	5,48			B

### 32 CAI



#### víčko

d mm	PN bar	m kg	objednáací kód	cena Kč	cena EUR	balení [ks]		sk
						MB	VB	
12	16		32 CAI 012	18,50	0,77		250	E
16	16	0,004	32 CAI 016	14,00	0,56		500	A
20	16	0,007	32 CAI 020	14,00	0,56		500	A
25	16	0,013	32 CAI 025	15,10	0,60		350	A
32	16	0,022	32 CAI 032	16,70	0,67		400	A
40	16	0,047	32 CAI 040	23,70	0,95		250	A
50	16	0,070	32 CAI 050	31,40	1,26		180	A
63	16	0,118	32 CAI 063	42,60	1,70		100	A
75	16	0,208	32 CAI 075	96,00	3,84		60	A
90	16	0,325	32 CAI 090	133,80	5,35		65	A
110	16	0,520	32 CAI 110	160,20	6,41		40	A
125	16	0,640	32 CAI 125	350,70	14,03		30	A
140	16	0,915	32 CAI 140	376,50	15,06		20	A
160	16	1,120	32 CAI 160	529,90	21,20		13	A
200	10	2,115	32 CAI 200	1 506,00	60,24		6	A
225	10	3,800	32 CAI 225	1 669,80	66,79		2	A
250	10		32 CAI 250	3 847,20	153,89			A

## PVC-UH tvarovky na lepení, závitové a přechodové

### 32 CAF

#### víčko závitové



G inch	PN bar	m kg	objednáací kód	cena Kč	cena EUR	balení [ks]		sk
						MB	VB	
3/8"	16	0,007	32 CAF 038	22,80	0,91		1000	A
1/2"	16	0,013	32 CAF 012	20,90	0,84		1200	A
3/4"	16	0,016	32 CAF 034	26,50	1,06		300	A
1"	16	0,020	32 CAF 100	28,70	1,15		180	A
1 1/4"	16	0,035	32 CAF 114	38,40	1,54		250	A
1 1/2"	16	0,050	32 CAF 112	43,90	1,76		150	A
2"	16	0,080	32 CAF 200	62,00	2,48		90	A
2 1/2"	16	0,190	32 CAF 212	206,40	8,26		70	A
3"	16	0,270	32 CAF 300	279,60	11,18		40	A
4"	16	0,420	32 CAF 400	396,10	15,84		25	A

### 32 TAF

#### zátká



G inch	PN bar	m kg	objednáací kód	cena Kč	cena EUR	balení [ks]		sk
						MB	VB	
1/4"	16		32 TAF 014	22,10	0,92		100	E
3/8"	16	0,008	32 TAF 038	15,40	0,62		1200	A
1/2"	16	0,010	32 TAF 012	15,40	0,62		650	A
3/4"	16	0,016	32 TAF 034	17,40	0,70		400	A
1"	16	0,024	32 TAF 100	21,60	0,86		600	A
1 1/4"	16	0,041	32 TAF 114	35,50	1,42		300	A
1 1/2"	16	0,044	32 TAF 112	40,30	1,61		250	A
2"	16	0,080	32 TAF 200	51,00	2,04		150	A
2 1/2"	16	0,137	32 TAF 212	178,80	7,15		80	A
3"	16	0,210	32 TAF 300	209,20	8,37		50	A
4"	16	0,340	32 TAF 400	359,80	14,39		60	A

### 32 DAF

#### maticé



G inch	PN bar	m kg	objednáací kód	cena Kč	cena EUR	balení [ks]		sk
						MB	VB	
1/2"		0,013	32 DAF 012	27,50	1,10		700	A
3/4"		0,016	32 DAF 034	29,50	1,18		600	A
1"		0,030	32 DAF 100	40,50	1,62		500	A
1 1/4"		0,035	32 DAF 114	51,50	2,06		450	A
1 1/2"		0,045	32 DAF 112	70,80	2,83		300	A
2"		0,090	32 DAF 200	101,70	4,07		150	A
2 1/2"		0,180	32 DAF 212	115,40	4,62		100	A
3"		0,230	32 DAF 300	128,50	5,14		60	A
4"		0,340	32 DAF 400	155,20	6,21		40	A

### 32 BOI

#### šroubení



d mm	PN bar	m kg	objednáací kód	cena Kč	cena EUR	balení [ks]		sk
						MB	VB	
12	16		32 BOI 012	68,00	2,83		200	E
16	16	0,025	32 BOI 016	49,60	1,98		200	A
20	16	0,042	32 BOI 020	51,00	2,04		150	A
25	16	0,066	32 BOI 025	64,20	2,57		200	A
32	16	0,092	32 BOI 032	70,00	2,80		120	A
40	16	0,160	32 BOI 040	104,00	4,16		80	A
50	16	0,200	32 BOI 050	133,90	5,36		50	A
63	16	0,355	32 BOI 063	177,70	7,11		30	A
75	16	0,575	32 BOI 075	497,70	19,91		15	A
90	16	0,765	32 BOI 090	583,50	23,34		12	A
110	16	1,285	32 BOI 110	675,40	27,02		12	A

### 32 BGO

#### převlečná maticé pro BOI, BOF a BOP



d x G mm x inch	PN bar	m kg	objednáací kód	cena Kč	cena EUR	balení [ks]		sk
						MB	VB	
16 x 3/4"	16	0,013	32 BGO 016	20,20	0,81			A
20 x 1"	16	0,015	32 BGO 020	20,90	0,84			A
25 x 1 1/4"	16	0,025	32 BGO 025	23,70	0,95			A
32 x 1 1/2"	16	0,035	32 BGO 032	32,80	1,31			A
40 x 2"	16	0,060	32 BGO 040	41,10	1,64			A
50 x 2 1/4"	16	0,080	32 BGO 050	55,10	2,20			A
63 x 2 3/4"	16	0,130	32 BGO 063	78,00	3,12			A
75 x 3 1/2"	16	0,200	32 BGO 075	235,00	9,40			A
90 x 4"	16	0,285	32 BGO 090	315,20	12,61			A
110 x 5"	16	0,445	32 BGO 110	328,40	13,14			A

## PVC-UH tvarovky na lepení, závitové a přechodové

### 32 BFI



#### závitový díl pro BOI

d x G mm x inch	PN bar	m kg	objednáací kód	cena Kč	cena EUR	balení [ks]		sk
						MB	VB	
20 x 1"	16	0,015	32 BFI 020	30,30	1,21			A
25 x 1 1/4"	16	0,025	32 BFI 025	35,00	1,40			A
32 x 1 1/2"	16	0,034	32 BFI 032	47,20	1,89			A
40 x 2"	16	0,057	32 BFI 040	61,30	2,45			A
50 x 2 1/4"	16	0,078	32 BFI 050	78,60	3,14			A
63 x 2 3/4"	16	0,134	32 BFI 063	100,30	4,01			A

### 32 BLI



#### vložný díl pro BOI a BOP

d mm	PN bar	m kg	objednáací kód	cena Kč	cena EUR	balení [ks]		sk
						MB	VB	
16	16	0,006	32 BLI 016	11,80	0,47			A
20	16	0,009	32 BLI 020	14,00	0,56			A
25	16	0,016	32 BLI 025	15,30	0,61			A
32	16	0,022	32 BLI 032	20,90	0,84			A
40	16	0,040	32 BLI 040	25,10	1,00			A
50	16	0,043	32 BLI 050	32,80	1,31			A
63	16	0,080	32 BLI 063	46,70	1,87			A
75	16	0,150	32 BLI 075	124,80	4,99			A
90	16	0,195	32 BLI 090	152,00	6,08			A
110	16	0,350	32 BLI 110	180,50	7,22			A

### 32 BLM



#### PP-H vložný díl polyfúzní pro BOI a BOP

d mm	PN bar	m kg	objednáací kód	cena Kč	cena EUR	balení [ks]		sk
						MB	VB	
16	10	0,004	32 BLM 016	47,90	2,00			E
20	10	0,006	32 BLM 020	24,30	0,97			A
25	10	0,010	36 122 025	52,00	2,17			H
32	10	0,015	32 BLM 032	27,60	1,10			A
40	10	0,027	32 BLM 040	33,00	1,32			A
50	10	0,029	32 BLM 050	38,40	1,54			A
63	10	0,055	32 BLM 063	64,70	2,59			A

### 32 BLEP



#### PE80 vložný díl polyfúzní pro BOI a BOP

d mm	PN bar	m kg	objednáací kód	cena Kč	cena EUR	balení [ks]		sk
						MB	VB	
20	10	0,006	32 BLEP 020	78,30	3,26			E
25	10	0,013	32 BLEP 025	91,20	3,80			E
32	10	0,015	32 BLEP 032	101,70	4,24			E
40	10	0,026	32 BLEP 040	132,10	5,50			E
50	10	0,025	32 BLEP 050	154,30	6,43			E
63	10	0,044	32 BLEP 063	171,80	7,16			E

### 32 BLEY



#### PE100 SDR11 vložný díl pro BOI a BOP pro elektrotvarovku

d mm	PN bar	m kg	objednáací kód	cena Kč	cena EUR	balení [ks]		sk
						MB	VB	
20	16	0,011	32 BLEY 020	136,80	5,70			E
25	16	0,018	32 BLEY 025	163,70	6,82			E
32	16	0,027	32 BLEY 032	199,90	8,33			E
40	16	0,045	32 BLEY 040	256,00	10,67			E
50	16	0,062	32 BLEY 050	266,50	11,10			E
63	16	0,100	32 BLEY 063	389,30	16,22			E

## PVC-UH tvarovky na lepení, závitové a přechodové

### 32 BOF



#### šroubení závitové

G inch	PN bar	m kg	objednací kód	cena Kč	cena EUR	balení [ks]		sk
						MB	VB	
3/8"	16	0,027	32 BOF 038	66,90	2,68		300	A
1/2"	16	0,044	32 BOF 012	73,90	2,96		350	A
3/4"	16	0,068	32 BOF 034	83,70	3,35		200	A
1"	16	0,095	32 BOF 100	108,80	4,35		140	A
1 1/4"	16	0,165	32 BOF 114	134,50	5,38		80	A
1 1/2"	16	0,250	32 BOF 112	182,00	7,28		50	A
2"	16	0,440	32 BOF 200	247,50	9,90		30	A
2 1/2"	16	0,610	32 BOF 212	693,00	27,72		15	A
3"	16	0,770	32 BOF 300	794,10	31,76		12	A
4"	16	1,280	32 BOF 400	917,60	36,70		12	A

### 32 BFF



#### závitový díl pro BOF a BOP

G x G inch	PN bar	m kg	objednací kód	cena Kč	cena EUR	balení [ks]		sk
						MB	VB	
3/8" x 3/4"	16	0,010	32 BFF 038	24,80	0,99			A
1/2" x 1"	16	0,016	32 BFF 012	41,10	1,64			A
3/4" x 1 1/4"	16	0,027	32 BFF 034	47,20	1,89			A
1" x 1 1/2"	16	0,036	32 BFF 100	60,00	2,40			A
1 1/4" x 2"	16	0,060	32 BFF 114	70,80	2,83			A
1 1/2" x 2 1/4"	16	0,104	32 BFF 112	99,00	3,96			A
2" x 2 3/4"	16	0,180	32 BFF 200	140,80	5,63			A
2 1/2" x 3 1/2"	16	0,235	32 BFF 212	402,00	16,08			A
3" x 4"	16	0,335	32 BFF 300	468,80	18,75			A
4" x 5"	16	0,470	32 BFF 400	525,30	21,01			A

### 32 BLF



#### vložný díl pro BOF

G inch	PN bar	m kg	objednací kód	cena Kč	cena EUR	balení [ks]		sk
						MB	VB	
3/8"	16	0,007	32 BLF 038	21,60	0,86			A
1/2"	16	0,010	32 BLF 012	23,70	0,95			A
3/4"	16	0,017	32 BLF 034	27,20	1,09			A
1"	16	0,023	32 BLF 100	37,00	1,48			A
1 1/4"	16	0,042	32 BLF 114	43,90	1,76			A
1 1/2"	16	0,065	32 BLF 112	60,00	2,40			A
2"	16	0,120	32 BLF 200	82,30	3,29			A
2 1/2"	16	0,160	32 BLF 212	205,60	8,22			A
3"	16	0,235	32 BLF 300	218,90	8,76			A
4"	16	0,340	32 BLF 400	260,10	10,40			A

### 32 ORD



#### O - kroužek pro šroubení (BOI/BOF/BOP/BMP), EPDM

d mm	PN bar	m kg	objednací kód	cena Kč	cena EUR	balení [ks]		sk
						MB	VB	
16			32 ORD 016	7,60 Kč	0,304			A
20			32 ORD 020	8,90 Kč	0,356			A
25			32 ORD 025	10,10 Kč	0,404			A
32			32 ORD 032	27,80 Kč	1,112			A
40			32 ORD 040	18,30 Kč	0,732			A
50			32 ORD 050	34,80 Kč	1,392			A
63			32 ORD 063	20,20 Kč	0,808			A
75			32 ORD 075	80,30 Kč	3,212			A
90			32 ORD 090	113,60 Kč	4,544			A
110			32 ORD 110	100,50 Kč	4,020			A



## PVC-UH tvarovky na lepení, závitové a přechodové

### 32 ORV



### O - kroužek pro šroubení (BOI/BOF/BOP/BMP), FPM

d mm	PN bar	m kg	objednací kód	cena Kč	cena EUR	balení [ks]		sk
						MB	VB	
16			32 ORV 016	16,30	0,679			B
20			32 ORV 020	32,60	1,358			B
25			32 ORV 025	41,60	1,733			B
32			32 ORV 032	46,20	1,925			B
40			32 ORV 040	107,00	4,458			B
50			32 ORV 050	119,00	4,958			B
63			32 ORV 063	134,00	5,583			B
75			32 ORV 075	190,00	7,917			B
90			32 ORV 090	209,00	8,708			B
110			32 ORV 110	247,00	10,292			B

### 32 BOP



### šroubení lepení x vnitřní závit

d x G mm x inch	PN bar	m kg	objednací kód	cena Kč	cena EUR	balení [ks]		sk
						MB	VB	
16 x 3/8"	16	0,031	32 BOP 016 038	62,80	2,51		200	A
20 x 1/2"	16	0,042	32 BOP 020 012	78,00	3,12		350	A
25 x 3/4"	16	0,070	32 BOP 025 034	88,50	3,54		200	A
32 x 1"	16	0,096	32 BOP 032 100	117,80	4,71		140	A
40 x 1 1/4"	16	0,155	32 BOP 040 114	137,30	5,49		80	A
50 x 1 1/2"	16	0,237	32 BOP 050 112	194,50	7,78		50	A
63 x 2"	16	0,405	32 BOP 063 200	254,50	10,18		30	A
75 x 2 1/2"	16	0,625	32 BOP 075 212	614,30	24,57		15	A
90 x 3"	16	0,865	32 BOP 090 300	704,90	28,20		12	A
110 x 4"	16	1,340	32 BOP 110 400	827,60	33,10		12	A

### 32 BMP



### šroubení lepení x vnější závit

d x G mm x inch	PN bar	m kg	objednací kód	cena Kč	cena EUR	balení [ks]		sk
						MB	VB	
25 x 3/4"	16	0,078	32 BMP 025 034V	142,30	5,93			E
32 x 1"	16	0,102	32 BMP 032 100	126,90	5,08			A
40 x 1 1/4"	16	0,163	32 BMP 040 114	147,80	5,91			A
50 x 1 1/2"	16	0,190	32 BMP 050 112	113,10	4,52		45	B
50 x 2"	16	0,300	32 BMP 050 200	113,10	4,52		40	B
63 x 2"	16	0,375	32 BMP 063 200	156,60	6,26		25	B
75 x 2 1/2"	10	0,630	32 BMP 075 212V	862,60	35,94		25	E
90 x 3"	10	0,330	32 BMP 090 300V	1 146,90	47,79		15	E

### 32 BMO



### šroubení lepení x vnější závit s O-kroužkem

d x G mm x inch	PN bar	m kg	objednací kód	cena Kč	cena EUR	balení [ks]		sk
						MB	VB	
50 x 1 1/2"	16	0,130	32 BMO 050 112	216,20	9,01		50	E
63 x 2"	16	0,220	32 BMO 063 200	300,60	12,53		72	E

### 32 BMF



### šroubení PVC x mosaz, lepení x vnitřní závit

d x G mm x inch	PN bar	m kg	objednací kód	cena Kč	cena EUR	balení [ks]		sk
						MB	VB	
16 x 3/8"	16	0,086	32 BMF 016 038	286,20	11,93			E
20 x 1/2"	16	0,144	32 BMF 020 012	257,30	10,29		50	E
25 x 3/4"	16	0,216	32 BMF 025 034	340,60	13,62		30	E
32 x 1"	16	0,282	32 BMF 032 100	438,70	17,55		30	E
40 x 1 1/4"	16	0,375	32 BMF 040 114	691,10	27,64		20	E
50 x 1 1/2"	16	0,478	32 BMF 050 112	818,60	32,74		20	E
63 x 2"	16	0,810	32 BMF 063 200	1 284,30	51,37		12	E
75 x 2 1/2"	16	1,340	32 BMF 075 212	2 528,70	101,15		6	E
90 x 3"	16	1,650	32 BMF 090 300	2 806,00	112,24		4	E

32 BMM



šroubení PVC x mosaz, lepení x vnější závit

d x G mm x inch	PN bar	m kg	objednací kód	cena Kč	cena EUR	balení [ks]		sk
						MB	VB	
16 x 3/8"	16	0,106	32 BMM 016 038	337,70	14,07			E
20 x 1/2"	16	0,169	32 BMM 020 012	274,60	10,98		50	E
25 x 3/4"	16	0,236	32 BMM 025 034	351,50	14,06		30	E
32 x 1"	16	0,327	32 BMM 032 100	460,10	18,40		30	E
40 x 1 1/4"	16	0,450	32 BMM 040 114	722,50	28,90		20	E
50 x 1 1/2"	16	0,568	32 BMM 050 112	877,30	35,09		20	E
63 x 2"	16	0,970	32 BMM 063 200	1 345,00	53,80		12	E
75 x 2 1/2"	16	1,550	32 BMM 075 212	2 959,70	118,39		6	E
90 x 3"	16	2,140	32 BMM 090 300	3 352,80	134,11		4	E



šroubení PVC x nerez 1.4404 (316L), EPDM, lepení x vnitřní závit

d x Rp mm x inch	PN bar	m kg	objednací kód	cena Kč	cena EUR	balení [ks]		sk
						MB	VB	
16 x 3/8"	16	0,053	721 540 205	766,00	31,92			H
20 x 1/2"	16	0,096	721 540 206	796,00	33,17			H
25 x 3/4"	16	0,154	721 540 207	902,00	37,58			H
32 x 1"	16	0,212	721 540 208	1 019,00	42,46			H
40 x 1 1/4"	16	0,356	721 540 209	1 408,00	58,67			H
50 x 1 1/2"	16	0,455	721 540 210	1 630,00	67,92			H
63 x 2"	16	0,721	721 540 211	2 089,00	87,04			H



šroubení PVC x nerez 1.4404 (316L), FPM, lepení x vnitřní závit

d x Rp mm x inch	PN bar	m kg	objednací kód	cena Kč	cena EUR	balení [ks]		sk
						MB	VB	
16 x 3/8"	16	0,053	721 540 230	796,00	33,17			H
20 x 1/2"	16	0,096	721 540 231	836,00	34,83			H
25 x 3/4"	16	0,154	721 540 232	933,00	38,88			H
32 x 1"	16	0,212	721 540 233	1 127,00	46,96			H
40 x 1 1/4"	16	0,356	721 540 234	1 530,00	63,75			H
50 x 1 1/2"	16	0,455	721 540 235	1 752,00	73,00			H
63 x 2"	16	0,721	721 540 236	2 240,00	93,33			H



šroubení PVC x nerez 1.4404 (316L), EPDM, lepení x vnější závit

d x R mm x inch	PN bar	m kg	objednací kód	cena Kč	cena EUR	balení [ks]		sk
						MB	VB	
16 x 3/8"	16	0,073	721 540 705	796,00	33,17			H
20 x 1/2"	16	0,126	721 540 706	836,00	34,83			H
25 x 3/4"	16	0,174	721 540 707	933,00	38,88			H
32 x 1"	16	0,262	721 540 708	1 055,00	43,96			H
40 x 1 1/4"	16	0,476	721 540 709	1 448,00	60,33			H
50 x 1 1/2"	16	0,535	721 540 710	1 666,00	69,42			H
63 x 2"	16	0,931	721 540 711	2 561,00	106,71			H



šroubení PVC x nerez 1.4404 (316L), FPM, lepení x vnější závit

d x R mm x inch	PN bar	m kg	objednací kód	cena Kč	cena EUR	balení [ks]		sk
						MB	VB	
16 x 3/8"	16	0,073	721 540 730	877,00	36,54			H
20 x 1/2"	16	0,126	721 540 731	866,00	36,08			H
25 x 3/4"	16	0,174	721 540 732	966,00	40,25			H
32 x 1"	16	0,262	721 540 733	1 102,00	45,92			H
40 x 1 1/4"	16	0,476	721 540 734	1 561,00	65,04			H
50 x 1 1/2"	16	0,535	721 540 735	1 768,00	73,67			H
63 x 2"	16	0,931	721 540 736	2 842,00	118,42			H

## PVC-UH tvarovky na lepení, závitové a přechodové

32 128



**nátrubek s převlečnou maticí**

d x G mm x inch	PN bar	m kg	objednací kód	cena Kč	cena EUR	balení [ks]		sk
						MB	VB	
32 x 5/4"	16		32 128 032	78,40	3,27		100	E
40 x 6/4"	16		32 128 040	107,30	4,47		100	E
50 x 2"	16		32 128 050	138,00	5,75		50	E
63 x 2 1/2"	10		32 128 063	273,90	11,41		50	E
75 x 3"	6		32 128 075	362,60	15,11		25	E

32 129



**hrdlo s převlečnou maticí**

d x G mm x inch	PN bar	m kg	objednací kód	cena Kč	cena EUR	balení [ks]		sk
						MB	VB	
25 x 1"	16		32 129 025 100	73,10	3,05		250	E
32 x 1"	10		32 129 032 100	80,30	3,35		200	E
32 x 5/4"	16		32 129 032 114	80,30	3,35		250	E
40 x 5/4"	10		32 129 040 114	109,40	4,56		100	E
40 x 6/4"	16		32 129 040 112	91,40	3,81		200	E
50 x 6/4"	10		32 129 050 112	142,10	5,92		100	E
50 x 2"	16		32 129 050 200	142,10	5,92		100	E
63 x 2"	10		32 129 063 200	235,20	9,80		25	E
63 x 2 1/2"	10		32 129 063 212	235,20	9,80		50	E
75 x 2 1/2"	6		32 129 075 212	362,60	15,11		25	E
75 x 3"	6		32 129 075 300	362,60	15,11		25	E
90 x 3"	6		32 129 090 300	521,90	21,75		25	E

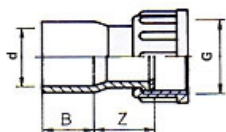

32 QRI



lemový nákrůžek vroubkovaný

d mm	PN bar	m kg	objednací kód	cena Kč	cena EUR	balení [ks]		sk
						MB	VB	
20	16	0,010	32 QRI 020	14,30	0,57		600	A
25	16	0,017	32 QRI 025	16,00	0,64		750	A
32	16	0,025	32 QRI 032	16,60	0,66		200	A
40	16	0,040	32 QRI 040	24,60	0,98		200	A
50	16	0,060	32 QRI 050	38,10	1,52		180	A
63	16	0,105	32 QRI 063	60,90	2,44		90	A
75	16	0,170	32 QRI 075	97,00	3,88		100	A
90	16	0,279	32 QRI 090	117,50	4,70		70	A
110	16	0,444	32 QRI 110	153,80	6,15		40	A
125	16	0,570	32 QRI 125	361,80	14,47		25	A
140	16	0,750	32 QRI 140	396,70	15,87		20	A
160	16	1,046	32 QRI 160	447,60	17,90		10	A
200	10	2,000	32 QRI 200	862,40	34,50		7	A
*200	16	2,700	32 QRI 201A	1 886,00	75,44			D
225	10	1,700	32 QRI 225	917,60	36,70		6	A
250	10	2,320	32 QRI 250	1 129,50	45,18		4	A
280	10	3,650	32 QRI 280	2 135,60	85,42		4	A
315	10	4,578	32 QRI 315	2 463,90	98,56		3	A
355	6	6,500	32 QRI 355	3 846,50	153,86			A
400	6	8,500	32 QRI 400	4 451,60	178,06			A

\* speciál pro uzavírací klapky s použitím FLI225

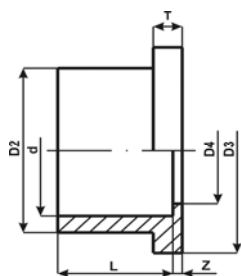

d mm	D2 mm	D3 mm	D4 mm	L mm	Z mm	T mm
20	27	34	15	16	3	6
25	33	41	21	19	3	7
32	41	50	27	22	3	7
40	50	61	36	26	3	8
50	61	73	47	31	3	8
63	76	90	58	38	3	9
75	90	106	69	44	3	10
90	107	125	82	51	5	11
110	131	150	101	61	5	12
125	147	167	117	69	5	12
140	163	187	132	76	7	13
160	185	213	149	86	6	16
180						
200	231	253	188	106	7	18
*200	248	273	193	106	24	30
225	247	274	210	119	8	19
250	273	307	239	131	10	20
280	308	329		142	10	23
315	346	379	305	161	11	27
355	391	432		185	9	25
400	437	481		206	11	25

32 FLI



příruba volná PVC-U

rozteč šroubů PN10

d/ DN mm	PN bar	m kg	objednáací kód	cena Kč	cena EUR	balení [ks]		sk
						MB	VB	
20/15	16	0,055	32 FLI 020	46,70	1,87		250	A
25/20	16	0,085	32 FLI 025	51,00	2,04		200	A
32/25	16	0,120	32 FLI 032	59,30	2,37		150	A
40/32	16	0,185	32 FLI 040	82,30	3,29		100	A
50/40	16	0,215	32 FLI 050	91,30	3,65		65	A
63/50	16	0,300	32 FLI 063	105,30	4,21		50	A
75/65	16	0,355	32 FLI 075	137,30	5,49		35	A
90/80	16	0,430	32 FLI 090	161,70	6,47		30	A
110/100	16	0,520	32 FLI 110	193,10	7,72		20	A
125/110	16	0,570	32 FLI 125 110	253,10	10,12		30	A
125/125	16	0,810	32 FLI 125 125	254,60	10,18			A
140/125	16	0,975	32 FLI 140	289,30	11,57		25	A
160/150	16	0,960	32 FLI 160	362,50	14,50		20	A
200/200	10	1,315	32 FLI 200	718,80	28,75		10	A
225/200	10	1,150	32 FLI 225	766,90	30,68		10	A
250/250	10	1,680	32 FLI 250	964,90	38,60		8	A
280/250	10	1,880	32 FLI 280	1 849,00	73,96		12	A
315/300	10	2,700	32 FLI 315	2 054,00	82,16		8	A

pro DN15 - DN175 je rozteč šroubů stejná jak pro PN10 tak pro PN16

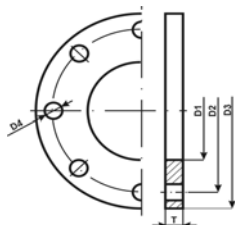

d/DN mm	D1 mm	D2 mm	D3 mm	počet děr	D4 mm	T mm
20/15	28	65	95	4	14	11
25/20	34	75	105	4	14	12
32/25	42	85	115	4	14	14
40/32	51	100	142	4	18	15
50/40	62	110	152	4	18	16
63/50	78	125	165	4	18	18
75/65	92	145	185	4	18	19
90/80	110	160	200	8	18	20
110/100	133	180	220	8	18	22
125/110	149	190	230	8	18	24
125/125	149	210	250	8	18	26
140/125	167	210	250	8	18	26
160/150	190	240	285	8	22	28
180/175		270		8	22	
200/200	235	295	340	8	22	30
225/200	250	295	340	8	22	30
250/250	280	350	395	12	22	34
280/250	310	350	395	12	22	30
315/300	349	400	445	12	22	34
355/350						
400/400						

32 KFLI

sada volné příruba FLI, lemové nákrůžky + šrouby a matice

d/DN mm	PN bar	m kg	objednáací kód	cena Kč	cena EUR	balení [ks]		sk
						MB	VB	
63/50	16		32 KFLI 063	402,60	16,10			B
75/65	16		32 KFLI 075	566,00	22,64			B
90/80	16		32 KFLI 090	786,00	31,44			B
110/100	16		32 KFLI 110	820,10	32,80			B
125/110	16		32 KFLI 125	1 471,70	58,87			B
140/125	16		32 KFLI 140	1 603,10	64,12			B
160/150	16		32 KFLI 160	2 096,40	83,86			B
200/200	10		32 KFLI 200	3 404,90	136,20			B
225/200	10		32 KFLI 225	3 635,70	145,43			B
250/250	10		32 KFLI 250	4 336,70	173,47			B
280/250	10		32 KFLI 280	7 933,40	317,34			B
315/300	10		32 KFLI 315	9 263,50	370,54			B

určeno pro vytvoření přířubového spoje, dodáváno bez těsnění

40 161/164



příruba volná PP s ocelovou vložkou

tlaková třída PN16, rozteč šroubů PN10

d/ DN mm	PN bar	m kg	objednáací kód	cena Kč	cena EUR	balení [ks]		sk
						MB	VB	
20/15	16	0,216	40 161 020	226,00	9,42			D
25/20	16	0,279	40 161 025	273,00	11,38			D
32/25	16	0,429	40 161 032	344,00	14,33			D
40/32	16	0,621	40 161 040	385,00	16,04			D
50/40	16	0,722	40 161 050C	462,00	18,48			C
63/50	16	1,084	40 161 063C	486,20	19,45			C
75/65	16	1,349	40 161 075C	547,10	21,88			C
90/80	16	1,369	40 164 090C	737,80	29,51			A
110/100	16	1,522	40 164 110C	786,30	31,45			A
125/100	16	1,250	40 164 126C	795,80	31,83			A
125/125	16	2,475	40 164 125	1 380,20	57,51			D
140/125	16	2,033	40 164 140C	963,30	38,53			A
160/150	16	3,167	40 164 160C	1 482,90	59,32			A
200/200	16	3,090	40 164 200C	1 861,30	74,45			A
225/200	16	4,448	40 164 225C	1 861,30	74,45			A
250/225	16	8,340	40 164 251	3 053,00	127,21			D
250/250	16	7,179	40 164 250C	2 601,10	104,04			A
280/250	16	5,547	40 164 280C	2 659,30	106,37			A
315/300	16	6,980	40 164 315C	3 678,30	147,13			A
355/350	16	12,465	40 164 355	8 856,40	369,02			D
400/400	16	17,607	40 164 400	10 078,40	419,93			D

pro DN15 - DN175 je vrtání přírub stejné jak pro PN10 tak pro PN16

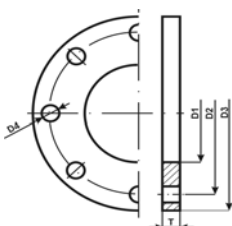

d/DN mm		D1 mm	D2 mm	D3 mm		počet děr	D4 mm	T mm
20/15		28	65	95		4	14	12
25/20		34	75	105		4	14	12
32/25		42	85	115		4	14	16
40/32		51	100	140		4	18	16
50/40		62	109	150		4	18	18
63/50		78	125	165		4	18	18
75/65		92	145	185		4	18	18
90/80		109	160	200		8	18	18
110/100		132	180	220		8	18	18
125/100		149	180	220		8	18	18
125/125		150	210	250		8	18	24
140/125		166	210	250		8	22	24
160/150		186	240	285		8	22	24
200/200		235	295	340		8	22	24
225/200		251	295	340		8	22	24
250/225		277	325	395		8	22	32
250/250		276	350	395		12	22	30
280/250		309	350	395		12	22	30
315/300		347	400	460		12	22	34
355/350		388	460	515		16	23	42
400/400		442	515	574		16	26	42

40 160/163



příruba volná PP-V

tlaková třída PN16, rozteč šroubů PN10

d/ DN mm	PN bar	m kg	objednáací kód	cena Kč	cena EUR	balení [ks]		sk
						MB	VB	
32/25	16	0,429	40 160 032	291,80	12,16			D
40/32	16	0,621	40 160 040	343,80	14,33			D
50/40	16	0,722	40 160 050	408,60	17,03			D
63/50	16	1,084	40 160 063	512,80	21,37			D
75/65	16	1,349	40 160 075	573,70	23,90			D
90/80	16	1,369	40 163 090	683,70	28,49			D
110/100	16	1,522	40 163 110	841,90	35,08			D

## PVC-UH tvarovky na lepení, závitové a přechodové

### 32 FFI



#### příruba pevná

d x DN mm	PN bar	m kg	objednáací kód	cena Kč	cena EUR	balení [ks]		sk
						MB	VB	
20 x 15	16	0,070	32 FFI 020	53,00	2,12		150	A
25 x 20	16	0,105	32 FFI 025	69,80	2,79		120	A
32 x 25	16	0,145	32 FFI 032	83,70	3,35		50	A
40 x 32	16	0,220	32 FFI 040	108,80	4,35		60	A
50 x 40	16	0,270	32 FFI 050	129,00	5,16		48	A
63 x 50	16	0,380	32 FFI 063	170,10	6,80		36	A
75 x 65	16	0,505	32 FFI 075	204,70	8,19		15	A
90 x 80	16	0,685	32 FFI 090	243,40	9,74		10	A
110 x 100	16	0,940	32 FFI 110	314,30	12,57		20	A
125 x 110	16	1,080	32 FFI 125	517,30	21,55			B
140 x 125	16	1,330	32 FFI 140	630,60	26,28			B
160 x 150	16	1,640	32 FFI 160	823,60	34,32			B

### 32 FCI



#### příruba zaslepovací

d/DN mm	PN bar	m kg	objednáací kód	cena Kč	cena EUR	balení [ks]		sk
						MB	VB	
50/40	16	0,270	32 FCI 050	134,50	5,38			A
63/50	16	0,370	32 FCI 063	171,10	6,84		40	A
75/65	16	0,495	32 FCI 075	193,10	7,72		35	A
90/80	16	0,630	32 FCI 090	225,20	9,01		30	A
110/100	16	0,800	32 FCI 110	291,30	11,65		20	A
125/110	16	0,890	32 FCI 125	383,50	15,34		18	A
140/125	16	1,000	32 FCI 140	453,20	18,13		15	A
160/150	16	1,300	32 FCI 160	506,90	20,28		10	A
200/200	10	2,480	32 FCI 200	978,80	39,15		10	A
225/200	10	2,480	32 FCI 225	1 010,20	40,41		10	A

### 32 GRN

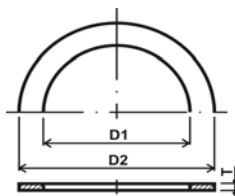

#### EPDM ploché těsnění pro přírbové spoje

d/DN mm	T mm		objednáací kód	cena Kč	cena EUR	D1 mm	D2 mm	sk
16	2		32 GRN 016	6,00	0,25	16	25	B
20/15	2		32 GRN 020	7,60	0,32	20	32	B
25/20	2		32 GRN 025	9,20	0,38	25	39	B
32/25	2		32 GRN 032	13,20	0,55	32	46	B
40/32	2		32 GRN 040	15,30	0,64	40	58	B
50/40	2		32 GRN 050	16,20	0,68	49	70	B
63/50	2		32 GRN 063	19,30	0,80	60	80	B
75/65	2		32 GRN 075	22,20	0,93	75	100	B
90/80	2		32 GRN 090	32,10	1,34	85	120	B
110/100	3		32 GRN 110	56,70	2,36	105	138	B
125/110	3		32 GRN 125	56,10	2,34	125	168	B
140/125	3		32 GRN 140	80,90	3,37	140	186	B
160/150	3		32 GRN 160	125,00	5,21	160	211	B
200/200	5		32 GRN 200	244,40	10,18	195	248	D
225/200	5		32 GRN 225	155,70	6,49	220	272	E
250/250	5		32 GRN 250	196,50	8,19	238	303	E
280/250	5		32 GRN 280	304,70	12,70	268	328	D
315/300	5		32 GRN 315	561,10	23,38	300	378	E
355/350	5		32 GRN 355	739,20	30,80			E
400/400	5		32 GRN 400	798,90	33,29			E

**35 002**

**EPDM gumokovové těsnění pro přírubové spoje G-ST-P/K**



d/DN mm	T mm	objednáací kód	cena Kč	cena EUR	D1 mm	D2 mm	sk
20/15	3/4	35 002 020	0,00	0,00			C
25/20	3/4	35 002 025	0,00	0,00			C
32/25	3/4	35 002 032	238,00	9,92			C
40/32	3/4	35 002 040	245,00	10,21			C
50/40	3/4	35 002 050	246,00	10,25			C
63/50	4/5	35 002 063	266,00	11,08			C
75/65	4/5	35 002 075	285,00	11,88			C
90/80	4/5	35 002 090	298,00	12,42			C
110/100	5/6	35 002 110	314,00	13,08			C
125/100-110	5/6	35 002 125 100	420,00	17,50			C
125/125	5/6	35 002 125 125	348,00	14,50			C
140/125	5/6	35 002 140	348,00	14,50			C
160/150	6/8	35 002 160	432,00	18,00			C
200/200	6/8	35 002 200	597,00	24,88			C
225/200	6/8	35 002 225	630,00	26,25			C
250/250	6/8	35 002 250	757,00	31,54			C
280/250	6/8	35 002 280	708,00	29,50			C
315/300	6/8	35 002 315 10	848,00	35,33			C

**35 003**

**FPM gumokovové těsnění pro přírubové spoje G-ST-P/K**



d/DN mm	T mm	objednáací kód	cena Kč	cena EUR	D1 mm	D2 mm	sk
20/15	3/4	35 003 020	0,00	0,00			E
25/20	3/4	35 003 025	0,00	0,00			E
32/25	3/4	35 003 032	1 051,00	43,79			E
40/32	3/4	35 003 040	1 088,00	45,33			E
50/40	3/4	35 003 050	1 126,00	46,92			E
63/50	4/5	35 003 063	1 198,00	49,92			E
75/65	4/5	35 003 075	1 272,00	53,00			E
90/80	4/5	35 003 090	1 361,00	56,71			E
110/100	5/6	35 003 110	1 393,00	58,04			E
125/100-110	5/6	35 003 125 100	0,00	0,00			E
140/125	5/6	35 003 140	1 470,00	61,25			E
160/150	6/8	35 003 160	1 796,00	74,83			E



32 DEI

nalepovací sedlo

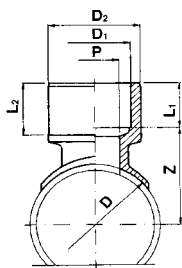

D x D1/D2 mm	PN bar	m kg	objednací kód	cena Kč	cena EUR	balení [ks]		sk
						MB	VB	
50 x 16/20	16	0,009	32 DEI 050 016	42,50	1,77		500	B
50 x 25/32	16	0,021	32 DEI 050 025	43,40	1,74		300	B
50 x 32/40	16	0,035	32 DEI 050 032	70,00	2,92		170	E
63 x 16/20	16	0,010	32 DEI 063 016	47,10	1,88		700	B
63 x 20/25	16	0,013	32 DEI 063 020	76,70	3,20		500	E
63 x 25/32	16	0,021	32 DEI 063 025	80,00	3,33		300	E
63 x 32/40	16	0,037	32 DEI 063 032	83,30	3,47		170	E
63 x 40/50	16	0,058	32 DEI 063 040	52,70	2,11		110	B
75 x 20/25	16	0,013	32 DEI 075 020	54,50	2,18		500	B
75 x 50/63	16	0,103	32 DEI 075 050	98,30	4,10		110	E
90 x 16/20	16	0,010	32 DEI 090 016	60,10	2,40		500	B
90 x 20/25	16	0,013	32 DEI 090 020	60,10	2,40		500	B
90 x 25/32	16	0,023	32 DEI 090 025	61,00	2,44		300	B
90 x 32/40	16	0,036	32 DEI 090 032	61,90	2,48		400	B
90 x 50/63	16	0,108	32 DEI 090 050	106,70	4,45		110	E
90 x 63/75	16	0,137	32 DEI 090 063	107,00	4,46		70	E
110 x 16/20	16	0,010	32 DEI 110 016	66,50	2,66		500	B
110 x 63/75	16	0,137	32 DEI 110 063	120,00	5,00		70	E
125 x 50/63	16	0,108	32 DEI 125 050	131,10	5,46		110	E
140 x 40/50	16	0,062	32 DEI 140 040	135,00	5,63		200	E
140 x 63/75	16	0,137	32 DEI 140 063	137,00	5,71		70	E
160 x 25/32	16	0,023	32 DEI 160 025	85,00	3,40		300	B
160 x 40/50	16	0,062	32 DEI 160 040	88,70	3,55		200	B
160 x 63/75	16	0,137	32 DEI 160 063	163,70	6,82		70	E
200 x 32/40	16	0,036	32 DEI 200 032	93,30	3,73		400	B
200 x 63/75	16	0,137	32 DEI 200 063	160,00	6,67		70	E
225 x 63/75	16	0,137	32 DEI 225 063	167,30	6,97		70	E
250 x 63/75	16	0,137	32 DEI 250 063	105,00	4,20		70	B
315 x 63/75	16	0,137	32 DEI 315 063	---	---		70	-

## PVC-UH tvarovky na lepení, závitové a přechodové

### 32 DEF

### nalepovací sedlo s vnitřním závitem DOPRODEJ

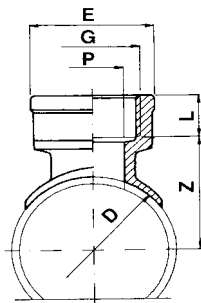

D x G mm x inch	PN bar	m kg	objednací kód	cena Kč	cena EUR	balení [ks]		sk
						MB	VB	
40 x 1/4"	16	0,010	32 DEF 040 014	15,30	0,61		500	Z
40 x 3/8"	16	0,010	32 DEF 040 038	15,00	0,63		500	Z
40 x 1/2"	16	0,015	32 DEF 040 012	25,00	1,00		500	Z
40 x 3/4"	16	0,023	32 DEF 040 034	15,00	0,60		500	Z
50 x 1/4"	16	0,010	32 DEF 050 014	16,10	0,67		500	Z
50 x 1/2"	16	0,015	32 DEF 050 012	19,20	0,80		500	Z
50 x 3/4"	16	0,023	32 DEF 050 034	16,80	0,70		270	Z
50 x 1"	16	0,030	32 DEF 050 100	17,50	0,70		170	Z
63 x 1/2"	16	0,015	32 DEF 063 012	20,50	0,85		500	Z
63 x 3/4"	16	0,023	32 DEF 063 034	19,40	0,81		270	Z
63 x 1"	16	0,039	32 DEF 063 100	19,80	0,79		170	Z
63 x 1 1/4"	16	0,060	32 DEF 063 114	21,20	0,85		110	Z
75 x 3/8"	16	0,010	32 DEF 075 038	23,40	0,98		500	Z
75 x 3/4"	16	0,022	32 DEF 075 034	22,40	0,93		270	Z
75 x 1"	16	0,037	32 DEF 075 100	22,70	0,95		170	Z
75 x 1 1/4"	16	0,060	32 DEF 075 114	24,00	0,96		65	Z
75 x 1 1/2"	16	0,095	32 DEF 075 112	24,00	0,96		120	Z
90 x 3/4"	16	0,022	32 DEF 090 034	22,40	0,90		270	Z
90 x 2"	16	0,105	32 DEF 090 200	30,10	1,20		90	Z
110 x 3/4"	16	0,023	32 DEF 110 034	27,80	1,11		270	Z
110 x 1"	16	0,037	32 DEF 110 100	28,20	1,13		170	Z
160 x 3/4"	16	0,025	32 DEF 160 034	35,70	1,43		270	Z
160 x 1"	16	0,036	32 DEF 160 100	37,10	1,48		170	Z
200 x 1"	16	0,036	32 DEF 200 100	38,80	1,55		170	Z
225 x 1 1/4"	16	0,036	32 DEF 225 114	40,60	1,62		110	Z
250 x 1 1/4"	16	0,105	32 DEF 250 114	41,60	1,66		110	Z
250 x 2"	16	0,105	32 DEF 250 200	49,00	1,96		90	Z
315 x 1 1/2"	16	0,095	32 DEF 315 112	42,50	1,70		120	Z

### 32 DMF

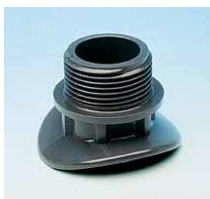

### nalepovací sedlo s vnějším závitem DOPRODEJ

D x G mm x inch	PN bar	m kg	objednací kód	cena Kč	cena EUR	balení [ks]		sk
						MB	VB	
32 x 1/2"	16	0,010	32 DMF 032 012	11,90	0,48		500	Z
40 x 1/2"	16	0,012	32 DMF 040 012	11,90	0,48		350	Z
40 x 3/4"	16	0,021	32 DMF 040 034	12,30	0,49		300	Z
50 x 1/2"	16	0,012	32 DMF 050 012	12,30	0,51		350	Z
50 x 3/4"	16	0,021	32 DMF 050 034	17,30	0,69		300	Z
50 x 1"	16	0,035	32 DMF 050 100	14,50	0,58		170	Z
63 x 1/2"	16	0,013	32 DMF 063 012	15,10	0,60		500	Z
63 x 3/4"	16	0,021	32 DMF 063 034	15,50	0,62		300	Z
63 x 1"	16	0,037	32 DMF 063 100	17,60	0,70		170	Z
63 x 1 1/4"	16	0,058	32 DMF 063 114	17,50	0,70		200	Z
90 x 1 1/2"	16	0,108	32 DMF 090 112	23,70	0,99		110	Z
140 x 1 1/2"	16	0,108	32 DMF 140 112	31,00	1,29		110	Z

## PVC-U uzavírací klapky

### 32 VFA 02



#### uzavírací klapka s pákou, EPDM

d/DN mm	PN bar	m kg	objednací kód	cena Kč	cena EUR	balení [ks]		sk
						MB	VB	
63/50	16	1,012	32 VFA 02 063	2 857,70	114,31		5	B
75/65	10	1,420	32 VFA 02 075	3 034,80	121,39		5	B
90/80	10	1,640	32 VFA 02 090	3 156,50	126,26		5	B
110/100	10	1,990	32 VFA 02 110	3 540,10	141,60		5	B
140/125	10	3,030	32 VFA 02 140	4 306,10	172,24		5	B
160/150	10	3,730	32 VFA 02 160	4 846,90	193,88		5	B
225/200	10	8,240	32 VFA 02 225	7 820,00	312,80		2	B

### 32 VFA 04



#### uzavírací klapka s pákou, EPDM, PP disk

d/DN mm	PN bar	m kg	objednací kód	cena Kč	cena EUR	balení [ks]		sk
						MB	VB	
75/65	10		32 VFA 04 075	2 116,80	84,67		4	A
90/80	10		32 VFA 04 090	2 406,80	96,27		4	A
110/100	10		32 VFA 04 110	2 648,60	105,94		4	A
140/125	10		32 VFA 04 140	3 101,90	124,08		5	A
160/150	10		32 VFA 04 160	3 610,20	144,41		5	A
225/200	10		32 VFA 04 225	5 452,80	218,11		6	A

### 32 VFA 03



#### uzavírací klapka s převodovkou, EPDM

d/DN mm	PN bar	m kg	objednací kód	cena Kč	cena EUR	balení [ks]		sk
						MB	VB	
280/250	6	18,600	32 VFA 03 280	48 823,10	1952,92		1	B
315/300	4	25,600	32 VFA 03 315	51 961,40	2078,46		1	B

### 32 SFFI



#### sada pevné přírby + šrouby a matice

d/DN mm	PN bar	m kg	objednací kód	cena Kč	cena EUR	balení [ks]		sk
						MB	VB	
63/50	16		32 SFFI 063	472,90	18,92		1	B
75/65	16		32 SFFI 075	471,90	18,88		1	B
90/80	16		32 SFFI 090	646,00	25,84		1	B
110/100	16		32 SFFI 110	1 007,00	40,28		1	B

určeno pro montáž uzavírací klapky 32 VFA 02/32 VFA 04

### 32 SFLI



#### sada volné přírby, lemové nákržky + šrouby a matice

d/DN mm	PN bar	m kg	objednací kód	cena Kč	cena EUR	balení [ks]		sk
						MB	VB	
63/50	16		32 SFLI 063	525,40	21,02		1	B
75/65	16		32 SFLI 075	649,30	25,97		1	B
90/80	16		32 SFLI 090	971,90	38,88		1	B
110/100	16		32 SFLI 110	1 108,40	44,34		1	B
125/125	16		32 SFLI 125	1 689,00	67,56		1	B
140/125	16		32 SFLI 140	1 817,80	72,71		1	B
160/150	16		32 SFLI 160	1 993,10	79,72		1	B
200/200	10		32 SFLI 200	5 928,80	237,15		1	D
225/200	10		32 SFLI 225	3 753,30	150,13		1	B
250/250	10		32 SFLI 250	5 123,60	204,94		1	B
280/250	10		32 SFLI 280	8 631,60	345,26		1	B
315/300	10		32 SFLI 315	10 946,90	437,88		1	B

určeno pro montáž uzavírací klapky 32 VFA 02/32 VFA 04

## PVC-U uzavírací klapky

### 32 VFA xxK



### uzavírací klapka s pákou a přírubovým kompletem

d/DN mm	PN bar	m kg	objednací kód	cena Kč	cena EUR	balení [ks]		sk
						MB	VB	
63/50	16		32 VFA 02K 063	3 406,00	136,24		1	B
75/65	10		32 VFA 02K 075	3 708,40	148,34		1	B
90/80	10		32 VFA 02K 090	4 153,80	166,15		1	B
110/100	10		32 VFA 02K 110	4 676,90	187,08		1	B
125/125	10		32 VFA 02K 125	6 029,50	241,18		1	B
140/125	10		32 VFA 02K 140	6 158,30	246,33		1	B
160/150	10		32 VFA 02K 160	6 878,80	275,15		1	B
200/200	10		32 VFA 02K 200	12 685,30	507,41		1	D
225/200	10		32 VFA 02K 225	11 635,90	465,44		1	B
250/250	6		32 VFA 03K 250	54 337,10	2 173,48		1	B
280/250	6		32 VFA 03K 280	57 845,30	2 313,81		1	B
315/300	4		32 VFA 03K 315	63 324,00	2 532,96		1	B
75/65	10		32 VFA 04K 075	2 605,30	104,21		1	B
90/80	10		32 VFA 04K 090	3 195,80	127,83		1	B
110/100	10		32 VFA 04K 110	3 555,70	142,23		1	B

klapka DN250 a DN300 s převodovkou

## PVC-U kulové kohouty průmyslové

řada BX: obráběná koule, PTFE sedla, dvojitý O-kroužek hřídele kličky, obrobené uložení hřídele kličky

### 32 BXI

#### kulový kohout 2 x šroubení - na lepení, EPDM



d mm	PN bar	m kg	objednací kód	cena Kč	cena EUR	balení [ks]		sk
						MB	VB	
16	16	0,140	32 BXI 016	494,70	19,79		50	A
20	16	0,140	32 BXI 020	500,50	20,02		50	A
25	16	0,200	32 BXI 025	575,50	23,02		30	A
32	16	0,300	32 BXI 032	701,50	28,06		50	A
40	16	0,450	32 BXI 040	916,70	36,67		30	A
50	16	0,690	32 BXI 050	1 137,10	45,48		20	A
63	16	1,150	32 BXI 063	1 460,50	58,42		12	A
75	16	3,100	32 BXI 075	3 423,10	136,92		3	A
90	16	3,250	32 BXI 090	4 399,20	175,97		3	A
110	16	5,500	32 BXI 110	5 712,00	228,48		2	A

### 32 BXE

#### kulový kohout 2 x šroubení, EPDM, konce PE100 SDR11



d mm	PN bar	m kg	objednací kód	cena Kč	cena EUR	balení [ks]		sk
						MB	VB	
25	16	0,200	32 BXE 025	840,20	33,61	1		A
32	16	0,300	32 BXE 032	985,60	39,42	1		A

dlouhé konce pro elektrotvarovky

řada BK: obráběná koule, PTFE sedla, dvojitý O-kroužek hřídele kličky, obrobené uložení hřídele kličky  
připraveno pro montáž pohonu a upevnění

### 32 BKI

#### kulový kohout 2 x šroubení - na lepení, EPDM



d mm	PN bar	m kg	objednací kód	cena Kč	cena EUR	balení [ks]		sk
						MB	VB	
16	16	0,140	32 BKI 016	662,30	26,49	1	50	A
20	16	0,140	32 BKI 020	676,80	27,07	1	50	A
25	16	0,200	32 BKI 025	828,20	33,13	1	20	A
32	16	0,300	32 BKI 032	984,10	39,36	1	20	A
40	16	0,450	32 BKI 040	1 263,90	50,56	1	14	A
50	16	0,690	32 BKI 050	1 615,90	64,64	1	14	A
63	16	1,150	32 BKI 063	2 003,30	80,13	1	5	A
75	16	3,100	32 BKI 075	4 758,30	190,33	1	1	A
90	16	3,250	32 BKI 090	6 104,90	244,20	1	1	A
110	16	5,500	32 BKI 110	8 506,50	340,26	1	1	A

### 32 BKIV

#### kulový kohout 2 x šroubení - na lepení, FPM



d mm	PN bar	m kg	objednací kód	cena Kč	cena EUR	balení [ks]		sk
						MB	VB	
16	16	0,140	32 BKIV 016	870,20	34,81	1	50	A
20	16	0,140	32 BKIV 020	882,60	35,30	1	50	A
25	16	0,200	32 BKIV 025	1 056,60	42,26	1	20	A
32	16	0,300	32 BKIV 032	1 284,40	51,38	1	20	A
40	16	0,450	32 BKIV 040	1 646,70	65,87	1	14	A
50	16	0,690	32 BKIV 050	2 092,70	83,71	1	14	A
63	16	1,150	32 BKIV 063	2 610,50	104,42	1	5	A
75	16	3,100	32 BKIV 075	6 195,00	247,80	1	1	A
90	16	3,250	32 BKIV 090	7 788,60	311,54	1	1	A
110	16	5,500	32 BKIV 110	10 572,20	422,89	1	1	A

32 348



sada pro montáž pneupohonu pro kohouty BK

d mm	PN bar	m kg	objednací kód	cena Kč	cena EUR	balení [ks]		sk
						MB	VB	
16-20	16	0,140	32 348 111	1 085,30	43,41	1	50	A
25	16	0,200	32 348 112	1 110,00	44,40	1	20	A
32	16	0,300	32 348 113	1 129,40	45,18	1	20	A
40	16	0,450	32 348 114	1 146,30	45,85	1	14	A
50	16	0,690	32 348 105	1 181,30	47,25	1	14	A
63	16	1,150	32 348 106	1 197,70	47,91	1	5	A
75-90	10	3,250	32 348 108	1 795,10	71,80	1	1	A
110	10	5,500	32 348 109	1 836,10	73,44	1	1	A

35 300



Pneumatický pohon jednočinný pro kohouty BK

d mm	PN bar	m kg	objednací kód	cena Kč	cena EUR	balení [ks]		sk
						MB	VB	
16 - 40		1,300	35 300 002	2 832,00	118,00			E
50 - 63		1,800	35 300 003	3 704,90	154,37			E
75 - 90		3,000	35 300 004	4 453,00	185,54			E
110		4,400	35 300 005	5 575,00	232,29			E

Pneumatický pohon dvojčinný pro kohouty BK

d mm	PN bar	m kg	objednací kód	cena Kč	cena EUR	balení [ks]		sk
						MB	VB	
16 - 40		1,100	35 300 012	2 463,00	102,63			E
50 - 63		1,600	35 300 013	2 800,00	116,67			E
75 - 110		2,700	35 300 014	3 780,00	157,50			E

32 348



sada pro montáž elektropohonu pro kohouty BK

d mm	PN bar	m kg	objednací kód	cena Kč	cena EUR	balení [ks]		sk
						MB	VB	
16-20	16	0,140	32 348 101	1 085,30	43,41	1	50	A
25	16	0,200	32 348 102	1 110,00	44,40	1	20	A
32	16	0,300	32 348 103	1 129,40	45,18	1	20	A
40	16	0,450	32 348 104	1 146,30	45,85	1	14	A
50	16	0,690	32 348 105	1 181,30	47,25	1	14	A
63	16	1,150	32 348 106	1 197,70	47,91	1	5	A
75-90	10	3,250	32 348 108	1 795,10	71,80	1	1	A
110	10	5,500	32 348 109	1 836,10	73,44	1	1	A

35 300



Elektrický pohon pro kohouty BK

d mm	PN bar	m kg	objednací kód	cena Kč	cena EUR	balení [ks]		sk
						MB	VB	
16 - 63		1,800	35 300 112	9 672,60	403,03			E
75 - 90		1,900	35 300 113	10 980,60	457,53			E
110		2,400	35 300 114	14 491,60	603,82			E

## PVC-U kulové kohouty průmyslové s pohonem

### 32 VKD



s pneupohonem DA

#### kulový kohout 2 x šroubení - na lepení, EPDM

d mm	PN bar	m kg	objednací kód	cena Kč	cena EUR	balení [ks]		sk
						MB	VB	
16	16		32 VKDIVDA 016E	10 060,00	402,40			E
20	16		32 VKDIVDA 020E	10 229,00	409,16			E
25	16		32 VKDIVDA 025E	10 229,00	409,16			E
32	16		32 VKDIVDA 032E	10 386,00	415,44			E
40	16		32 VKDIVDA 040E	10 733,00	429,32			E
50	16		32 VKDIVDA 050E	11 142,00	445,68			E
63	16		32 VKDIVDA 063E	11 562,00	462,48			E
75	16		32 VKDIVDA 075E	16 312,00	652,48			E
90	16		32 VKDIVDA 090E	20 705,00	828,20			E
110	16		32 VKDIVDA 110E	28 634,00	1145,36			E

### 32 VKD



s pneupohonem NC

#### kulový kohout 2 x šroubení - na lepení, EPDM

d mm	PN bar	m kg	objednací kód	cena Kč	cena EUR	balení [ks]		sk
						MB	VB	
16	16		32 VKDIVNC 016E	10 519,00	420,76			E
20	16		32 VKDIVNC 020E	10 519,00	420,76			E
25	16		32 VKDIVNC 025E	10 676,00	427,04			E
32	16		32 VKDIVNC 032E	10 942,00	437,68			E
40	16		32 VKDIVNC 040E	11 206,00	448,24			E
50	16		32 VKDIVNC 050E	11 873,00	474,92			E
63	16		32 VKDIVNC 063E	12 339,00	493,56			E
75	16		32 VKDIVNC 075E	17 532,00	701,28			E
90	16		32 VKDIVNC 090E	23 723,00	948,92			E
110	16		32 VKDIVNC 110E	31 003,00	1240,12			E

### 32 VKD



s pneupohonem NO

#### kulový kohout 2 x šroubení - na lepení, EPDM

d mm	PN bar	m kg	objednací kód	cena Kč	cena EUR	balení [ks]		sk
						MB	VB	
16	16		32 VKDIVNO 016E	10 519,00	420,76			E
20	16		32 VKDIVNO 020E	10 519,00	420,76			E
25	16		32 VKDIVNO 025E	10 676,00	427,04			E
32	16		32 VKDIVNO 032E	10 942,00	437,68			E
40	16		32 VKDIVNO 040E	11 206,00	448,24			E
50	16		32 VKDIVNO 050E	11 873,00	474,92			E
63	16		32 VKDIVNO 063E	12 339,00	493,56			E
75	16		32 VKDIVNO 075E	17 532,00	701,28			E
90	16		32 VKDIVNO 090E	23 723,00	948,92			E
110	16		32 VKDIVNO 110E	31 003,00	1240,12			E

### 32 VKD



s elektropohonem 90-240V AC  
možno objednat i s elektropohonem 24V AC/DC

#### kulový kohout 2 x šroubení - na lepení, EPDM

d mm	PN bar	m kg	objednací kód	cena Kč	cena EUR	balení [ks]		sk
						MB	VB	
16	16		32 VKDIVEM 016E	19 581,00	783,24			B
20	16		32 VKDIVEM 020E	17 111,00	684,44			B
25	16		32 VKDIVEM 025E	17 240,00	689,60			B
32	16		32 VKDIVEM 032E	17 368,00	694,72			B
40	16		32 VKDIVEM 040E	17 509,00	700,36			B
50	16		32 VKDIVEM 050E	17 781,00	711,24			B
63	16		32 VKDIVEM 063E	18 477,00	739,08			B
75	16		32 VKDIVEM 075E	28 974,00	1158,96			D
90	16		32 VKDIVEM 090E	31 700,00	1268,00			D
110	16		32 VKDIVEM 110E	38 410,00	1536,40			D

32 VKDIVEL

## PVC-U kulové kohouty serie AQUA

řada VSA: obráběná koule, PE sedla, dvojitý O-kroužek hřídele kličky

### 32 VSA 22I



#### kulový kohout 2 x šroubení - na lepení, EPDM, safeblock

d mm	PN bar	m kg	objednací kód	cena Kč	cena EUR	balení [ks]		sk
						MB	VB	
16	16	0,130	32 VSA 22I 016P	205,50	8,22		50	A
20	16	0,130	32 VSA 22I 020P	205,50	8,22		50	A
25	16	0,205	32 VSA 22I 025P	234,20	9,37		30	A
32	16	0,300	32 VSA 22I 032P	317,30	12,69		50	A
40	16	0,435	32 VSA 22I 040P	421,60	16,86		30	A
50	16	0,670	32 VSA 22I 050P	495,80	19,83		20	A
63	16	1,125	32 VSA 22I 063P	748,10	29,92		12	A
75	10	2,090	32 VSA 22I 075P	2 657,70	106,31		3	A
90	10	3,310	32 VSA 22I 090P	3 478,40	139,14		3	A
110	10	5,925	32 VSA 22I 110P	4 573,00	182,92		2	A

### 32 VSA 22F



#### kulový kohout 2 x šroubení - závitový, EPDM, safeblock

G inch	PN bar	m kg	objednací kód	cena Kč	cena EUR	balení [ks]		sk
						MB	VB	
3/4"	16	0,205	32 VSA 22F 034P	234,70	9,39		30	A
1"	16	0,300	32 VSA 22F 100P	342,80	13,71		50	A
1 1/4"	16	0,430	32 VSA 22F 114P	429,70	17,19		30	A
1 1/2"	16	0,655	32 VSA 22F 112P	502,80	20,11		20	A

### 32 VSA 18P



#### kulový kohout lepení x svěrná spojka, EPDM, bez safeblocku

d x d mm	PN bar	m kg	objednací kód	cena Kč	cena EUR	balení [ks]		sk
						MB	VB	
63 x 63	16	1,125	32 VSA 18P 063	190,00	7,60			Z

doprodej

### 32 VSA 21I



#### kulový kohout 2 x šroubení - na lepení, EPDM, bez safeblocku

d mm	PN bar	m kg	objednací kód	cena Kč	cena EUR	balení [ks]		sk
						MB	VB	
25	16	0,205	32 VSA 21I 025	49,00	1,96			Z

doprodej



## PVC-U kulové kohouty

### 32 KTE



#### sada těsnění pro kulové kohouty BX a BK, EPDM + PTFE

d mm	PN bar	m kg	objednací kód	cena	cena	balení [ks]		sk
				Kč	EUR	MB	VB	
16-20			32 KTE 020	57,10	2,28	1		D
25			32 KTE 025	76,20	3,05	1		D
32			32 KTE 032	105,90	4,24	1		D
40			32 KTE 040	162,80	6,51	1		D
50			32 KTE 050	235,40	9,42	1		D
63			32 KTE 063	272,20	10,89	1		D
75			32 KTE 075	360,40	14,42	1		D
90			32 KTE 090	448,20	17,93	1		D
110			32 KTE 110	574,20	22,97	1		D

### 32 KTV



#### sada těsnění pro kulové kohouty BK, FPM + PTFE

d mm	PN bar	m kg	objednací kód	cena	cena	balení [ks]		sk
				Kč	EUR	MB	VB	
16-20			32 KTV 020	286,80	11,47	1		D
25			32 KTV 025	397,90	15,92	1		D
32			32 KTV 032	538,20	21,53	1		D
40			32 KTV 040	808,60	32,34	1		D
50			32 KTV 050	1 111,80	44,47	1		D
63			32 KTV 063	1 621,30	64,85	1		D
75			32 KTV 075	1 972,70	78,91	1		D
90			32 KTV 090	2 514,10	100,56	1		D
110			32 KTV 110	2 875,00	115,00	1		D

### 32 348



#### O-kroužek EPDM pod vložný díl VSA, BX, BK

d mm	PN bar	m kg	objednací kód	cena	cena	balení [ks]		sk
				Kč	EUR	MB	VB	
16-20			32 348 011	15,80	0,63	1		A
25			32 348 012	7,90	0,33	1		E
32			32 348 013	13,80	0,58	1		E
40			32 348 014	24,40	1,02	1		E
50			32 348 015	26,40	1,10	1		E
63			32 348 016	37,50	1,56	1		E
75-90			32 348 018	29,70	1,19	1		A
110			32 348 019	28,70	1,15	1		A

### 32 HAN



#### klíčka oranžová pro kulové kohouty BX a BK

d mm	PN bar	m kg	objednací kód	cena	cena	balení [ks]		sk
				Kč	EUR	MB	VB	
16 - 20			32 HAN 020	22,20	0,89			A
25			32 HAN 025	26,90	1,08			A
32			32 HAN 032	35,10	1,40			A
40			32 HAN 040	39,20	1,57			A
50			32 HAN 050	49,80	1,99			A
63			32 HAN 063	60,00	2,40			A
75 - 90			32 HAN 090	142,10	5,68			A
110			32 HAN 110	190,00	7,60			A

### 32 HBN



#### klíčka modrá pro kulové kohouty VSA

d mm	PN bar	m kg	objednací kód	cena	cena	balení [ks]		sk
				Kč	EUR	MB	VB	
16 - 20			32 HBN 020	22,20	0,89			A
25			32 HBN 025	26,30	1,05			A
32			32 HBN 032	34,40	1,38			A
40			32 HBN 040	38,40	1,54			A
50			32 HBN 050	49,80	1,99			A
63			32 HBN 063	60,00	2,40			A
75 - 90			32 HBN 090	142,10	5,68			A
110			32 HBN 110	190,00	7,60			A

## PVC-U kulové kohouty

### 32 349



#### klíčka šedá pro kulové kohouty VSI

d mm	PN bar	m kg	objednáací kód	cena Kč	cena EUR	balení [ks]		sk
						MB	VB	
25			32 349 025	22,10	0,88			A
32			32 349 032	34,10	1,36			A
40			32 349 040	41,10	1,64			A
50			32 349 050	49,90	2,00			A
63			32 349 063	66,30	2,65			A

### 32 VCI



#### PVC-U vložný díl do kulových kohoutů - lepení

d mm	PN bar	m kg	objednáací kód	cena Kč	cena EUR	balení [ks]		sk
						MB	VB	
16	16		32 VCI 016	11,40	0,46			A
20	16		32 VCI 020	11,40	0,46			A
25	16		32 VCI 025	14,20	0,57			A
32	16		32 VCI 032	16,80	0,67			A
40	16		32 VCI 040	19,50	0,78			A
50	16		32 VCI 050	25,80	1,03			A
63	16		32 VCI 063	41,80	1,67			A
75	10		32 VCI 075P	124,60	4,98			A
90	10		32 VCI 090P	130,00	5,20			A
110	10		32 VCI 110	193,30	7,73			A

### 32 VCF



#### PVC-U vložný díl do kulových kohoutů - závit

G inch	PN bar	m kg	objednáací kód	cena Kč	cena EUR	balení [ks]		sk
						MB	VB	
3/8"	16		32 VCF 038	22,20	0,89			A
1/2"	16		32 VCF 012	22,20	0,89			A
3/4"	16		32 VCF 034	25,00	1,00			A
1"	16		32 VCF 100	27,60	1,10			A
1 1/4"	16		32 VCF 114	33,00	1,32			A
1 1/2"	16		32 VCF 112	44,40	1,78			A
2"	16		32 VCF 200	55,20	2,21			A
2 1/2"	10		32 VCF 212P	152,20	6,09			A
3"	10		32 VCF 300P	166,20	6,65			A
4"	10		32 VCF 400	235,10	9,40			A

### 32 VCY



#### PVC-U vložný nátrubek pro kulové kohouty

d mm	PN bar	m kg	objednáací kód	cena Kč	cena EUR	balení [ks]		sk
						MB	VB	
16	16		32 VCY 016	15,00	0,60			B
20	16		32 VCY 020	15,00	0,60			B
25	16		32 VCY 025	16,20	0,65			B
32	16		32 VCY 032	18,50	0,74			B
40	16		32 VCY 040	23,10	0,92			B
50	16		32 VCY 050	28,90	1,16			B

### 32 VEY



#### PE100 SDR11 vložný nátrubek pro kulové kohouty

d mm	PN bar	m kg	objednáací kód	cena Kč	cena EUR	balení [ks]		sk
						MB	VB	
20	16		32 VEY 020P	244,50	9,78			D
25	16		32 VEY 025P	144,20	5,77			A
32	16		32 VEY 032P	173,80	6,95			A
40	16		32 VEY 040P	191,30	7,65			A
50	16		32 VEY 050P	221,60	8,86			A
63	16		32 VEY 063P	274,10	10,96			A
75	10		32 VEY 075P	454,60	18,18			A
90	10		32 VEY 090P	453,90	18,16			A
110	10		32 VEY 110P	547,60	21,90			A

## PVC-U kulové kohouty

### 32 VEP



### PE100 vložný díl polyfuzní pro kulové kohouty

d mm	PN bar	m kg	objednací kód	cena Kč	cena EUR	balení [ks]		sk
						MB	VB	
20	10	0,008	32 VEP 020	93,50	3,90			E
25	10	0,012	32 VEP 025	106,40	4,43			E
32	10	0,019	32 VEP 032	116,90	4,87			E

### 32 VPP



### vložný díl PP-H do kulových kohoutů polyfuzní

d mm	PN bar	m kg	objednací kód	cena Kč	cena EUR	balení [ks]		sk
						MB	VB	
20	10		32 VPP 020	46,80	1,87			D
25	10		32 VPP 025	50,20	2,01			D
32	10		32 VPP 032	69,10	2,76			D
40	10		32 VPP 040	111,00	4,44			D
50	10		32 VPP 050	133,30	5,33			D
63	10		32 VPP 063	163,20	6,53			D

### 32 VPY



### PP-H SDR11 vložný nátrubek pro kulové kohouty

d mm	PN bar	m kg	objednací kód	cena Kč	cena EUR	balení [ks]		sk
						MB	VB	
32	10		32 VPY 032	197,60	8,23			E
40	10		32 VPY 040	50,30	2,01			B
50	10		32 VPY 050	53,00	2,12			B

### 32 31I



### kulový kohout třícestný - pro lepení, EPDM

d mm	PN bar	m kg	objednací kód	cena Kč	cena EUR	balení [ks]		sk
						MB	VB	
16	10	0,272	32 31IT 016	534,50	22,27			E
20	10	0,272	32 31IT 020	572,40	23,85			E
25	10	0,364	32 31IT 025	704,20	29,34			E
32	10	0,572	32 31IT 032	856,60	35,69			E
40	10	0,842	32 31IT 040	1 089,20	45,38			E
50	10	1,418	32 31IT 050	1 340,40	55,85			E
63	10	1,750	32 31IT 063	1 606,10	66,92			E
16	10	0,226	32 31IL 016	572,40	23,85			E
20	10	0,294	32 31IL 020	572,40	23,85			E
25	10	0,360	32 31IL 025	704,20	29,34			E
32	10	0,574	32 31IL 032	856,60	35,69			E
40	10	0,868	32 31IL 040	1 089,20	45,38			E
50	10	1,420	32 31IL 050	1 427,00	59,46			E
63	10	1,748	32 31IL 063	2 339,00	97,46			E

### kulový kohout třícestný - pro lepení, FPM

d mm	PN bar	m kg	objednací kód	cena Kč	cena EUR	balení [ks]		sk
						MB	VB	
20	10	0,272	32 31ITV 020	737,90	30,75			E
25	10	0,364	32 31ITV 025	969,30	40,39			E
32	10	0,572	32 31ITV 032	1 197,40	49,89			E
40	10	0,842	32 31ITV 040	1 497,30	62,39			E
50	10	1,418	32 31ITV 050	1 703,90	71,00			E
63	10	1,750	32 31ITV 063	2 001,70	83,40			E
20	10	0,294	32 31ILV 020	737,90	30,75			E
25	10	0,360	32 31ILV 025	1 035,70	43,15			E
32	10	0,574	32 31ILV 032	1 197,40	49,89			E
40	10	0,868	32 31ILV 040	1 497,30	62,39			E
50	10	1,420	32 31ILV 050	1 703,90	71,00			E
63	10	1,748	32 31ILV 063	2 154,60	89,78			E

## PVC-U kulové kohouty - série pro zavlažování

### 32 VSA 11I



#### kulový kohout s jedním šroubením, na lepení, EPDM

d mm	PN bar	m kg	objednací kód	cena Kč	cena EUR	balení [ks]		sk
						MB	VB	
20	16	0,100	32 VSA 11I 020	114,10	4,56		120	A
25	16	0,155	32 VSA 11I 025	153,30	6,13		80	A
32	16	0,240	32 VSA 11I 032	145,70	5,83		60	A
40	16	0,350	32 VSA 11I 040	238,80	9,55		30	A
50	16	0,550	32 VSA 11I 050	271,50	10,86		20	A
63	16	0,930	32 VSA 11I 063	449,50	17,98		10	A

### 32 VSI 12F



#### kulový kohout - vnitřní závit x vnitřní závit

G inch	PN bar	m kg	objednací kód	cena Kč	cena EUR	balení [ks]		sk
						MB	VB	
1/2"	16	0,095	32 VSI 12F 012	127,00	5,08		120	A
3/4"	16	0,150	32 VSI 12F 034	153,30	6,13		80	A
1"	16	0,220	32 VSI 12F 100	160,40	6,42		60	A
1 1/4"	16	0,320	32 VSI 12F 114	238,80	9,55		30	A
1 1/2"	16	0,490	32 VSI 12F 112	276,80	11,07		20	A
2"	16	0,830	32 VSI 12F 200	449,50	17,98		10	A
2 1/2"	10	1,525	32 VSI 12F 212	1 224,30	48,97		4	A
3"	10	2,260	32 VSI 12F 300	1 270,50	50,82		4	A
4"	6	4,370	32 VSI 12F 400	2 171,20	86,85		2	A

### 32 VSI 13F



#### kulový kohout - vnitřní závit x vnější závit

G inch	PN bar	m kg	objednací kód	cena Kč	cena EUR	balení [ks]		sk
						MB	VB	
1/2"	16	0,095	32 VSI 13F 012	120,60	4,82		120	A
3/4"	16	0,150	32 VSI 13F 034	139,90	5,60		80	A
1"	16	0,210	32 VSI 13F 100	150,40	6,02		50	A
1 1/4"	16	0,320	32 VSI 13F 114	231,20	9,25		30	A
1 1/2"	16	0,500	32 VSI 13F 112	262,80	10,51		20	A
2"	16	0,845	32 VSI 13F 200	404,40	16,18		10	A

### 32 VSI 14P



#### kulový kohout - vnitřní závit x hadicový trn

G x d inch x mm	PN bar	m kg	objednací kód	cena Kč	cena EUR	balení [ks]		sk
						MB	VB	
1" x 32	16	0,260	32 VSI 14P 032	39,00	1,56			Z

### 32 VSI 16G



#### kulový kohout - svěrný spoj x svěrný spoj

d mm	PN bar	m kg	objednací kód	cena Kč	cena EUR	balení [ks]		sk
						MB	VB	
20	16	0,156	32 VSI 16G 020	220,00	8,80		70	A
25	16	0,235	32 VSI 16G 025	220,00	8,80		40	A
32	16	0,365	32 VSI 16G 032	262,80	10,51		30	A

### 32 VSI 16P



#### kulový kohout - vnitřní závit x svěrný spoj

G x d inch x mm	PN bar	m kg	objednací kód	cena Kč	cena EUR	balení [ks]		sk
						MB	VB	
1/2" x 20	16	0,135	32 VSI 16P 020	137,50	5,50		100	A
3/4" x 25	16	0,200	32 VSI 16P 025	159,20	6,37		60	A
1" x 32	16	0,290	32 VSI 16P 032	176,20	7,05		40	A
1 1/4" x 40	16	0,460	32 VSI 16P 040	271,50	10,86		20	A
1 1/2" x 50	16	0,730	32 VSI 16P 050	311,90	12,48		15	A
2" x 63	16	1,220	32 VSI 16P 063	470,50	18,82		8	A

## PVC-U nožová šoupata, membránové ventily

32 440



### nožové šoupě na lepení

d mm	PN bar	m kg	objednací kód	cena Kč	cena EUR	balení [ks]		sk
						MB	VB	
50	3		32 440 050	699,80	29,16		25	E
63	2		32 440 063	1 060,60	44,19		12	E
75	1,5		32 440 075	1 771,30	73,80		8	E
90	1		32 440 090	2 378,90	99,12		6	E
110	1		32 440 110	3 710,40	154,60		4	E

32 441



### nožové šoupě na lepení s nerezovým nožem

d mm	PN bar	m kg	objednací kód	cena Kč	cena EUR	balení [ks]		sk
						MB	VB	
110	0,5		32 441 110	4 601,40	191,73		3	E
d125/DN100	0,5		32 441 125	7 143,00	297,63		4	E
160	0,5		32 441 160	7 423,50	309,31		1	E
200	0,5		32 441 200	16 309,70	679,57		1	E

šoupě d125 je DN100 a d125 je vnější lepení

514



### PVC-U membránový ventil, EPDM

d mm	PN bar	m kg	objednací kód	cena Kč	cena EUR	balení [ks]		sk
						MB	VB	
16	10		161 514 011	2 098,00	87,42		1	H
20	10		161 514 012	2 176,00	90,67		1	H
25	10		161 514 013	2 458,00	102,42		1	H
32	10		161 514 014	3 024,00	126,00		1	H
40	10		161 514 015	3 605,00	150,21		1	H
50	10		161 514 016	4 737,00	197,38		1	H
63	10		161 514 017	5 115,00	213,13		1	H

514



### PVC-U membránový ventil, PTFE/EPDM

d mm	PN bar	m kg	objednací kód	cena Kč	cena EUR	balení [ks]		sk
						MB	VB	
16	10		161 514 031	4 195,00	174,79		1	H
20	10		161 514 032	4 348,00	181,17		1	H
25	10		161 514 033	4 625,00	192,71		1	H
32	10		161 514 034	5 514,00	229,75		1	H
40	10		161 514 035	6 929,00	288,71		1	H
50	10		161 514 036	8 900,00	370,83		1	H
63	6		161 514 037	10 931,00	455,46		1	H

514



### PVC-U membránový ventil, FPM

d mm	PN bar	m kg	objednací kód	cena Kč	cena EUR	balení [ks]		sk
						MB	VB	
16	10		161 514 061	4 195,00	174,79		1	H
20	10		161 514 062	4 348,00	181,17		1	H
25	10		161 514 063	4 625,00	192,71		1	H
32	10		161 514 064	5 514,00	229,75		1	H
40	10		161 514 065	6 929,00	288,71		1	H
50	10		161 514 066	8 900,00	370,83		1	H
63	10		161 514 067	10 931,00	455,46		1	H

624



**PVC-U membránový ventil pneumatický NC, EPDM**

d mm	PN bar	m kg	objednací kód	cena Kč	cena EUR	balení [ks]		sk
						MB	VB	
16	10		161 624 011	7 000,00	291,67		1	H
20	10		161 624 012	7 289,00	303,71		1	H
25	10		161 624 013	7 734,00	322,25		1	H
32	10		161 624 014	8 137,00	339,04		1	H
40	10		161 624 015	10 198,00	424,92		1	H
50	10		161 624 016	12 258,00	510,75		1	H
63	10		161 624 017	15 639,00	651,63		1	H

624



**PVC-U membránový ventil pneumatický NC, PTFE/EPDM**

d mm	PN bar	m kg	objednací kód	cena Kč	cena EUR	balení [ks]		sk
						MB	VB	
16	10		161 624 031	9 099,00	379,13		1	H
20	10		161 624 032	9 337,00	389,04		1	H
25	10		161 624 033	10 026,00	417,75		1	H
32	10		161 624 034	10 600,00	441,67		1	H
40	10		161 624 035	13 291,00	553,79		1	H
50	10		161 624 036	15 924,00	663,50		1	H
63	6		161 624 037	20 279,00	844,96		1	H

624



**PVC-U membránový ventil pneumatický NC, FPM**

d mm	PN bar	m kg	objednací kód	cena Kč	cena EUR	balení [ks]		sk
						MB	VB	
16	10		161 624 061	8 090,00	337,08		1	H
20	10		161 624 062	8 455,00	352,29		1	H
25	10		161 624 063	8 923,00	371,79		1	H
32	10		161 624 064	9 547,00	397,79		1	H
40	10		161 624 065	11 665,00	486,04		1	H
50	10		161 624 066	14 794,00	616,42		1	H
63	10		161 624 067	18 273,00	761,38		1	H

## PVC-U Zpětné ventily

### 32 VRF 11I



#### zpětný ventil s PP sacím košem pro lepení

**DOPRODEJ**

d mm	PN bar	m kg	objednáací kód	cena Kč	cena EUR	balení [ks]		sk
						MB	VB	
25	16	0,120	32 VRF 11I 025	69,00	2,88			Z

### VRF 11F



#### zpětný ventil s PP sacím košem závitový

**DOPRODEJ**

G inch	PN bar	m kg	objednáací kód	cena Kč	cena EUR	balení [ks]		sk
						MB	VB	
2"	16	0,700	32 VRF 11F 200	99,00	4,13			Z

### 32 SCP



#### PP sací koš pro zpětný ventil VRF 11

**DOPRODEJ**

d mm	PN bar	m kg	objednáací kód	cena Kč	cena EUR	balení [ks]		sk
						MB	VB	
32			32 SCP 032	20,00	0,80			Z
40			32 SCP 040	21,00	0,84			Z
50			32 SCP 050	22,00	0,88			Z
75 - 90			32 SCP 090	89,00	3,56			Z

## PVC-U Zpětné ventily

### 32 CVI



#### zpětný ventil s nerezovou pružinou, EPDM, na lepení

d mm	PN bar	m kg	objednací kód	cena Kč	cena EUR	balení [ks]		sk
						MB	VB	
20	16	0,110	32 CVI 020	295,70	11,83		50	A
25	16	0,180	32 CVI 025	355,10	14,20		32	A
32	16	0,250	32 CVI 032	380,30	15,21		22	A
40	16	0,380	32 CVI 040	447,60	17,90		27	A
50	16	0,600	32 CVI 050C	664,40	26,58		18	B
63	16	1,000	32 CVI 063C	895,60	35,82		10	B
75	10	2,800	32 CVI 075C	2 094,20	83,77		5	B
90	10	3,000	32 CVI 090C	2 673,00	106,92		3	B
110	10	5,000	32 CVI 110	4 078,60	163,14		2	A

### 32 CVF



#### zpětný ventil s nerezovou pružinou, EPDM, závitový

G inch	PN bar	m kg	objednací kód	cena Kč	cena EUR	balení [ks]		sk
						MB	VB	
3/4"	16	0,180	32 CVF 034C	0,00	0,00		32	B
1"	16	0,250	32 CVF 100	410,30	16,41		22	A
1 1/4"	16	0,380	32 CVF 114C	0,00	0,00		27	B
1 1/2"	16	0,600	32 CVF 112C	690,60	27,62		18	B
2"	16	1,000	32 CVF 200C	927,40	37,10		10	B

### 32 CVIT



#### zpětný ventil s nerezovou poteflonovanou pružinou, EPDM, na lepení

d mm	PN bar	m kg	objednací kód	cena Kč	cena EUR	balení [ks]		sk
						MB	VB	
20	16	0,110	32 CVIT 020	532,00	21,28		50	A
25	16	0,180	32 CVIT 025	594,90	23,80		32	A
32	16	0,250	32 CVIT 032	622,20	24,89		22	A
40	16	0,380	32 CVIT 040	725,50	29,02		27	A
50	16	0,600	32 CVIT 050	948,40	37,94		18	A
63	16	1,000	32 CVIT 063	1 213,30	48,53		10	A
75	10	2,800	32 CVIT 075	2 523,30	100,93		5	A
90	10	3,000	32 CVIT 090	3 174,70	126,99		3	A

### 32 CVITV



#### zpětný ventil s nerezovou poteflonovanou pružinou, FPM, na lepení

d mm	PN bar	m kg	objednací kód	cena Kč	cena EUR	balení [ks]		sk
						MB	VB	
20	16	0,110	32 CVITV 020	664,00	26,56		50	A
25	16	0,180	32 CVITV 025	735,30	29,41		32	A
32	16	0,250	32 CVITV 032	778,80	31,15		22	A
40	16	0,380	32 CVITV 040	906,10	36,24		27	A
50	16	0,600	32 CVITV 050	1 162,70	46,51		18	A
63	16	1,000	32 CVITV 063	1 501,40	60,06		10	A
75	10	2,800	32 CVITV 075C	3 253,00	130,12		5	B
90	10	3,000	32 CVITV 090C	4 117,00	164,68		3	B

### 32 MOL



#### nerezová pružina pro zpětný ventil CV

d mm	PN bar	m kg	objednací kód	cena Kč	cena EUR	balení [ks]		sk
						MB	VB	
20			32 MOL 020	53,20	2,13			A
25			32 MOL 025	54,50	2,18			A
32			32 MOL 032	68,70	2,75			A
40			32 MOL 040	99,70	3,99			A
50			32 MOL 050	110,50	4,42			A
63			32 MOL 063	163,60	6,54			A
75 - 90			32 MOL 090	310,50	12,42			A
110			32 MOL 110	785,30	31,41			A



32 MOX



nerozová poteflonovaná pružina pro zpětný ventil CV

d mm	PN bar	m kg	objednací kód	cena Kč	cena EUR	balení [ks]		sk
						MB	VB	
20			32 MOX 020	295,70	11,83			A
25			32 MOX 025	309,20	12,37			A
32			32 MOX 032	321,90	12,88			A
40			32 MOX 040	344,20	13,77			A
50			32 MOX 050	350,90	14,04			A
63			32 MOX 063	421,60	16,86			A
75 - 90			32 MOX 090	562,30	22,49			A

32 HVI



zpětný ventil bez pružiny, na lepení

d mm	PN bar	m kg	objednací kód	cena Kč	cena EUR	balení [ks]		sk
						MB	VB	
20	16	0,110	32 HVI 020C	0,00	0,00	1	50	B
25	16	0,180	32 HVI 025C	0,00	0,00	1	32	B
32	16	0,250	32 HVI 032C	0,00	0,00	1	22	B
40	16	0,380	32 HVI 040C	0,00	0,00	1	27	B
50	16	0,600	32 HVI 050C	664,40	26,58	1	18	B
63	16	1,000	32 HVI 063C	895,60	35,82	1	10	B
75	10	2,800	32 HVI 075C	2 094,20	83,77	1	5	B
90	10	3,000	32 HVI 090C	2 673,00	106,92	1	3	B
110	10	5,000	32 HVI 110C	0,00	0,00	1	2	B

32 ZVD



sací koš pro HV

d mm	PN bar	m kg	objednací kód	cena Kč	cena EUR	balení [ks]		sk
						MB	VB	
20			32 ZVD 020	87,30	3,49			A
25			32 ZVD 025	100,60	4,02			A
32			32 ZVD 032	121,30	4,85			A
40			32 ZVD 040	141,10	5,64			A
50			32 ZVD 050	210,90	8,44			A
63			32 ZVD 063	252,20	10,09			A
75/90			32 ZVD 090	353,00	14,12			A
110			32 ZVD 110	383,00	15,32			A

32 450



zpětný ventil Y na lepení, s PVC koulí, EPDM

d mm	PN bar	m kg	objednací kód	cena Kč	cena EUR	balení [ks]		sk
						MB	VB	
20	10	0,099	32 450 020	444,80	18,53			E
25	10	0,154	32 450 025	516,80	21,53			E
32	10	0,216	32 450 032	827,70	34,49			E
40	10	0,420	32 450 040	934,80	38,95			E
50	10	0,691	32 450 050	1 268,40	52,85			E
63	10	1,125	32 450 063	1 805,80	75,24			E
75	10	3,420	32 450 075	3 640,40	151,68			E
90	10	4,102	32 450 090	5 188,80	216,20			E

32 AVI

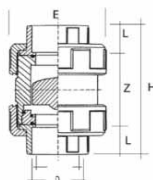

odvzdušňovací ventil, na lepení

d mm	PN bar	m kg	objednací kód	cena Kč	cena EUR	balení [ks]		sk
						MB	VB	
20	16	0,110	32 AVI 020	312,80	12,51	1	60	A
25	16	0,180	32 AVI 025	374,60	14,98	1	40	A
32	16	0,250	32 AVI 032	402,10	16,08	1	60	A
40	16	0,380	32 AVI 040	438,50	17,54	1	40	A
50	16	0,600	32 AVI 050	645,30	25,81	1	24	A
63	16	1,000	32 AVI 063	846,70	33,87	1	13	A
75	10	2,800	32 AVI 075	2 047,80	81,91	1	3	A
90	10	3,000	32 AVI 090	2 660,00	106,40	1	3	A
110	10	5,000	32 AVI 110	3 504,80	140,19	1	2	A

32 271



zpětná klapka mezipřírubová, EPDM, bez pružiny

d/DN mm	PN bar	m kg	objednací kód	cena Kč	cena EUR	balení [ks]		sk
						MB	VB	
63/50	10	0,310	32 271 063	881,00	36,71	1		B
75/65	10	0,406	32 271 075	935,00	38,96	1		B
90/80	10	0,468	32 271 090	1 100,00	45,83	1		B
110/100	10	0,660	32 271 110	1 325,00	55,21	1		B
125/110	10	0,584	32 271 125	1 551,00	64,63	1		B
140/125	10	0,850	32 271 140	1 733,00	72,21	1		B
160/150	10	1,252	32 271 160	1 886,00	78,58	1		B
200/175	10	1,369	32 271 200	2 259,00	94,13	1		B
225/200	10	2,230	32 271 225	2 703,00	112,63	1		B
280/250	10	3,380	32 271 250	3 235,00	134,79	1		B
315/300	10	4,865	32 271 315	3 871,00	161,29	1		B

32 273



zpětná klapka mezipřírubová, EPDM, bez pružiny

s přírubovým kompletem

d/DN mm	PN bar	m kg	objednací kód	cena Kč	cena EUR	balení [ks]		sk
						MB	VB	
63/50	10	2,046	32 273 063	1 278,10	51,12	1		B
75/65	10	2,278	32 273 075	1 463,90	58,56	1		B
90/80	10	3,468	32 273 090	1 827,20	73,09	1		B
110/100	10	4,120	32 273 110	2 177,70	87,11	1		B
125/110	10	4,938	32 273 125	2 908,50	116,34	1		B
140/125	10	5,346	32 273 140	3 476,80	139,07	1		B
160/150	10	7,736	32 273 160	3 864,60	154,58	1		B
200/175	10	11,608	32 273 200	5 767,00	230,68	1		B
225/200	10	9,628	32 273 225	6 405,60	256,22	1		B
250/200	10	18,835	32 273 250	8 046,20	321,85	1		B
280/250	10	17,429	32 273 280	11 585,30	463,41	1		B
315/300	10	20,745	32 273 315	13 848,50	553,94	1		B

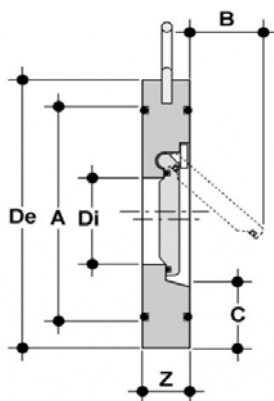

d/DN mm	Z mm	De mm	objednací kód	Di mm	A mm	Xhor bar	Xver bar	Y bar
63/50	20	109	32 271 063	32	86	0,001	0,004	0,4
75/65	20	129	32 271 075	40	105	0,001	0,004	0,3
90/80	20	144	32 271 090	54	119	0,001	0,007	0,2
110/100	22	164	32 271 110	70	146	0,001	0,007	0,2
125/110	24	170	32 271 125	82		0,001	0,010	
140/125	23	195	32 271 140	92	173	0,001	0,007	0,3
160/150	25	220	32 271 160	112	197	0,001	0,007	0,1
200/175	27	248	32 271 200	138		0,001	0,016	
225/200	35	275	32 271 225	154	225	0,001	0,012	0,1
280/250	40	330	32 271 280	192	312	0,001	0,012	0,1
315/300	45	380	32 271 315	227	363	0,001	0,012	0,1

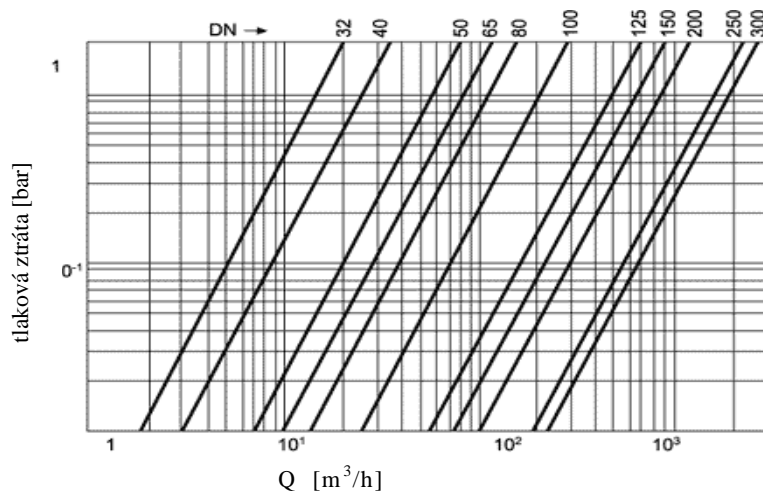

Jestliže chcete instalovat klapku na výlačnou stranu čerpadla, nikdy neinstalujte klapku přímo na přírubu čerpadla.

Dále neinstalujte klapku hned za nebo před koleno.

Na obou stranách klapky je požadována stabilizační zóna v délce pětinasobku DN klapky.

## PVC-U Filtr

### 305



### filtr transparentní, EPDM, nátrubky na lepení

d mm	PN bar	m kg	objednáací kód	cena Kč	cena EUR	balení [ks]		sk
						MB	VB	
20	10	0,122	192 305 300	987,00	41,13			H
25	10	0,170	192 305 350	1 173,00	48,88			H
32	10	0,255	192 305 400	1 542,00	64,25			H
40	10	0,384	192 305 450	1 931,00	80,46			H
50	10	0,635	192 305 500	2 607,00	108,63			H
63	10	1,059	192 305 550	3 298,00	137,42			H
75	10	1,838	192 305 600	5 282,00	220,08			H
90	10	2,565	192 305 650	5 902,00	245,92			H

### filtr transparentní, FPM, nátrubky na lepení

d mm	PN bar	m kg	objednáací kód	cena Kč	cena EUR	balení [ks]		sk
						MB	VB	
20	10	0,122	192 305 349	1 173,00	48,88			H
25	10	0,170	192 305 399	1 334,00	55,58			H
32	10	0,255	192 305 449	1 649,00	68,71			H
40	10	0,384	192 305 499	2 093,00	87,21			H
50	10	0,635	192 305 549	3 059,00	127,46			H
63	10	1,059	192 305 599	3 694,00	153,92			H
75	10	1,838	192 305 649	6 333,00	263,88			H
90	10	2,565	192 305 699	6 868,00	286,17			H

### PVC-U sítko k filtru 305, otvor 0,5mm



kv pro  $\Delta p=1\text{bar}$

d mm	m kg	kv l/min	objednáací kód	cena Kč	cena EUR	balení [ks]		sk
						MB	VB	
20	5	35	161 305 339	159,00	6,63			H
25	7	65	161 305 389	159,00	6,63			H
32	3	90	161 305 439	183,00	7,63			H
40	4	155	161 305 489	226,00	9,42			H
50	7	225	161 305 539	261,00	10,88			H
63	10	370	161 305 589	355,00	14,79			H
75	12	575	161 305 639	396,00	16,50			H
90	17	955	161 305 689	469,00	19,54			H

### PVC-U sítko k filtru 305, otvor 0,8mm

d mm	m kg	kv l/min	objednáací kód	cena Kč	cena EUR	balení [ks]		sk
						MB	VB	
20	5	35	161 305 338	159,00	6,63			H
25	7	65	161 305 388	159,00	6,63			H
32	3	90	161 305 438	183,00	7,63			H
40	4	155	161 305 488	226,00	9,42			H
50	7	225	161 305 538	261,00	10,88			H
63	10	370	161 305 588	355,00	14,79			H
75	12	575	161 305 638	396,00	16,50			H
90	17	955	161 305 688	469,00	19,54			H

### PVC-U sítko k filtru 305, otvor 1,4mm

d mm	m kg	kv l/min	objednáací kód	cena Kč	cena EUR	balení [ks]		sk
						MB	VB	
20	5	35	161 305 337	161,00	6,71			H
25	7	65	161 305 387	161,00	6,71			H
32	3	90	161 305 437	183,00	7,63			H
40	4	155	161 305 487	227,00	9,46			H
50	7	225	161 305 537	262,00	10,92			H
63	10	370	161 305 587	355,00	14,79			H
75	12	575	161 305 637	397,00	16,54			H
90	17	955	161 305 687	469,00	19,54			H

### PVC-U sítko k filtru 305, otvor 2,2mm

d mm	m kg	kv l/min	objednáací kód	cena Kč	cena EUR	balení [ks]		sk
						MB	VB	
20	5	35	161 305 336	161,00	6,71			H
25	7	65	161 305 386	161,00	6,71			H
32	3	90	161 305 436	183,00	7,63			H
40	4	155	161 305 486	227,00	9,46			H
50	7	225	161 305 536	262,00	10,92			H
63	10	370	161 305 586	355,00	14,79			H
75	12	575	161 305 636	397,00	16,54			H
90	17	955	161 305 686	469,00	19,54			H

**nerozové sítko k filtru 305, otvor 0,5mm ocel 1.4404**



kv pro  $\Delta p=1\text{bar}$

d mm	m kg	kv l/min	objednáací kód	cena Kč	cena EUR	balení [ks]		sk
						MB	VB	
20	5	35	161 486 100	205,00	8,54			H
25	7	60	161 486 101	265,00	11,04			H
32	3	85	161 486 102	286,00	11,92			H
40	4	130	161 486 103	325,00	13,54			H
50	7	200	161 486 104	397,00	16,54			H
63	10	330	161 486 105	441,00	18,38			H
75	12	460	161 486 106	753,00	31,38			H
90	17	665	161 486 107	873,00	36,38			H

**PVC-U Rotametry**

**rotametr 335**

trubice transparentní PVC-U, EPDM, PVDF plovák, PVC-U vložné díly



d	PN bar	m kg	objednáací kód	cena Kč	cena EUR	průtok l/hod.	sk
32	10	0,440	32 250 000	4 958,00	206,58	50 - 500	H
32	10	0,440	32 250 001	4 958,00	206,58	100 - 1000	H
40	10	0,620	32 250 002	5 892,00	245,50	150 - 1500	H
40	10	0,620	32 250 003	5 892,00	245,50	250 - 2500	H
50	10	0,900	32 250 004	6 683,00	278,46	200 - 2000	H
50	10	0,900	32 250 005	6 332,00	263,83	300 - 3000	H
50	10	0,900	32 250 006	6 683,00	278,46	600 - 6000	H
63	10	1,225	32 250 007	10 299,00	429,13	600 - 6000	H
63	10	1,225	32 250 008	11 194,00	466,42	1000 - 10000	H
63	10	1,225	32 250 009	10 634,00	443,08	1500 - 15000	H
75	10	2,150	32 250 010	15 512,00	646,33	2000 - 20000	H
75	10	2,150	32 250 011	15 512,00	646,33	3000 - 30000	H
75	10	2,150	32 250 012	17 585,00	732,71	8000 - 60000	H

trubice transparentní PVC-U, EPDM, PVDF plovák s magnetem, PVC-U vložné díly

d	PN bar	m kg	objednáací kód	cena Kč	cena EUR	průtok l/hod.	sk
32	10	0,440	32 250 100	6 637,00	276,54	50 - 500	H
32	10	0,440	32 250 101	6 637,00	276,54	100 - 1000	H
40	10	0,620	32 250 102	7 716,00	321,50	150 - 1500	H
40	10	0,620	32 250 103	7 863,00	327,63	250 - 2500	H
50	10	0,900	32 250 104	9 186,00	382,75	200 - 2000	H
50	10	0,900	32 250 105	9 361,00	390,04	300 - 3000	H
50	10	0,900	32 250 106	9 361,00	390,04	600 - 6000	H
63	10	1,225	32 250 107	15 011,00	625,46	600 - 6000	H
63	10	1,225	32 250 108	15 011,00	625,46	1000 - 10000	H
63	10	1,225	32 250 109	15 011,00	625,46	1500 - 15000	H
75	10	2,150	32 250 110	19 094,00	795,58	2000 - 20000	H
75	10	2,150	32 250 111	19 520,00	813,33	3000 - 30000	H
75	10	2,150	32 250 112	19 520,00	813,33	8000 - 60000	H

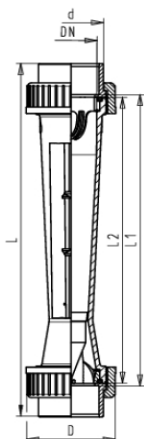

typ	L2 mm	L1 mm	L mm	D mm	d mm
d32 50-500 l/h	335	341	385	58	32
d32 100-1000 l/h	335	341	385	58	32
d40 150-1500 l/h	335	341	393	72	40
d40 250-2500 l/h	335	341	393	72	40
d50 200-2000 l/h	335	341	403	83	50
d50 300-3000 l/h	335	341	403	83	50
d50 600-6000 l/h	335	341	403	83	50
d63 600-6000 l/h	335	341	417	101	63
d63 1000-10000 l/h	335	341	417	101	63
d63 1500-15000 l/h	335	341	417	101	63
d75 2000-20000 l/h	335	341	429	135	75
d75 3000-30000 l/h	335	341	429	135	75
d75 8000-60000 l/h	335	341	429	135	75

**rotametr**

trubice transparentní PVC-U, EPDM, PVDF plovák, PVC-U vložné díly



typ	PN bar	m kg	objednáací kód	cena Kč	cena EUR	průtok l/hod.	sk
SK50-d16	10		198 803 310	3 251,00	135,46	2,5 - 25	H
SK51-d16	10		198 803 311	3 251,00	135,46	5 - 50	H
SK52-d16	10		198 803 312	3 251,00	135,46	10 - 100	H
SK60-d20	10		198 803 313	3 490,00	145,42	8 - 80	H
SK61-d20	10		198 803 314	3 490,00	145,42	15 - 150	H
SK62-d20	10		198 803 315	3 490,00	145,42	20 - 200	H
SK70-d32	10		198 803 316	4 091,00	170,46	15 - 150	H
SK71-d32	10		198 803 317	4 091,00	170,46	30 - 300	H
SK72-d32	10		198 803 318	4 091,00	170,46	50 - 500	H
SK73-d32	10		198 803 319	4 091,00	170,46	100 - 1000	H

trubice transparentní PVC-U, EPDM, PVDF plovák s magnetem, PVC-U vložné díly

typ	PN bar	m kg	objednáací kód	cena Kč	cena EUR	průtok l/hod.	sk
SK500-d16	10		198 803 320	5 354,00	223,08	2,5 - 25	H
SK510-d16	10		198 803 321	5 354,00	223,08	5 - 50	H
SK520-d16	10		198 803 322	5 354,00	223,08	10 - 100	H
SK600-d20	10		198 803 323	5 716,00	238,17	8 - 80	H
SK610-d20	10		198 803 324	5 716,00	238,17	15 - 150	H
SK620-d20	10		198 803 325	5 716,00	238,17	20 - 200	H
SK700-d32	10		198 803 326	6 678,00	278,25	15 - 150	H
SK710-d32	10		198 803 327	6 678,00	278,25	30 - 300	H
SK720-d32	10		198 803 328	6 678,00	278,25	50 - 500	H
SK730-d32	10		198 803 329	6 678,00	278,25	100 - 1000	H

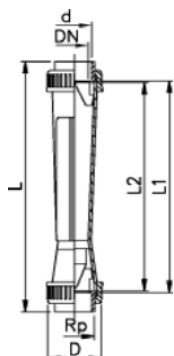

typ	L2 mm	L1 mm	L mm	D mm	d mm
SK50/SK500-d16	165	171	199	35	16
SK51/SK510-d16	165	171	199	35	16
SK52/SK520-d16	165	171	199	35	16
SK60/SK600-d20	185	191	223	43	20
SK61/SK610-d20	185	191	223	43	20
SK62/SK620-d20	185	191	223	43	20
SK70/SK700-d32	200	206	250	60	32
SK71/SK710-d32	200	206	250	60	32
SK72/SK720-d32	200	206	250	60	32
SK73/SK730-d32	200	206	250	60	32

**snímač max. průtoku pro 335, 350 a SK500-730**

typ	PN bar	m kg	objednáací kód	cena Kč	cena EUR	balení [ks]		sk
						MB	VB	
GK11			198 335 999	2 393,00	99,708			H



**snímač min. průtoku pro 335 a 350 a SK500-730**

typ	PN bar	m kg	objednáací kód	cena Kč	cena EUR	balení [ks]		sk
						MB	VB	
GK10			198 335 998	2 454,00	102,25			H

**snímač průtoku 4 - 20 mA**

typ	pro l/hod	objednáací kód	cena Kč	cena EUR	balení [ks]		sk
					MB	VB	
GK15	50 - 500	199 335 962	20 824,00	867,67			H
GK15	100 - 1000	199 335 963	20 824,00	867,67			H
GK15	150 - 1500	199 335 964	20 641,00	860,04			H
GK15	250 - 2500	199 335 965	20 824,00	867,67			H
GK15	200 - 2000	199 335 966	20 824,00	867,67			H
GK15	300 - 3000	199 335 967	21 715,00	904,79			H
GK15	600 - 6000	199 335 968	21 715,00	904,79			H
GK15	600 - 6000	199 335 969	21 715,00	904,79			H
GK15	1000 - 10000	199 335 991	23 602,00	983,42			H
GK15	1500 - 15000	199 335 992	23 602,00	983,42			H
GK15	2000 - 20000	199 335 993	21 715,00	904,79			H
GK15	3000 - 30000	199 335 994	21 715,00	904,79			H
GK15	8000 - 60000	199 335 995	21 715,00	904,79			H



## PP-H

System průmyslového potrubí z PP-H zahrnuje kompletní řadu trubek a tvarovek svařitelných polyfuzně i na tupo včetně ručních i pohonovaných armatur. Celý sortiment je vyráběn z homopolymery polypropylenu. Ten se vyznačuje vysokou hodnotou obvodové pevnosti a zajišťuje tak prodlouženou životnost zařízení bez významných mechanických či fyzikálních poškození. PP-H je termoplast ze skupiny polyolefinů s vynikajícími mechanickými vlastnostmi, tepelnou stálostí i dobrou chemickou odolností.

### Základní informace

- trubky PN6 v dimenzích od d25 mm do d400 mm
- trubky PN10 v dimenzích od d20 mm do d400 mm
- teplotní rozsah od 0°C do +80°C, krátkodobě do 95°C
- spojování svařováním na tupo nebo polyfuzně

### Hlavní charakteristiky a výhody

- plně kompatibilní systém trubek, tvarovek a ventilů
- vysoká mechanická odolnost proti napětí a tahu
- vysoká teplotní stálost
- výborná rázová houževnatost, dobré elektroizolační vlastnosti s téměř nulovou nasákavostí kondenzátu
- vynikající chemickou odolností vůči kyselinám (kromě oxidačních kyselin), zásadám a slabým rozpouštědlům
- fyziologická nezávadnost
- nízká hmotnost a snadná manipulace
- vysoká odolnost proti stárnutí
- dobrá odolnost proti povětrnostním vlivům nikoliv však proti UV záření

### Kde se PP-H používá

- chemický průmysl
- úprava vody
- odpadové hospodářství
- energetika
- strojírenství
- galvanotechnika

### Pro co se PP-H používá

- kyseliny (kromě organických), zásady a další chemikálie - viz tabulka chemické odolnosti
- chladicí voda
- pitná voda
- slaná voda
- odpadní a znečištěná voda
- bazénová technika
- alkoholy a potravinářská media

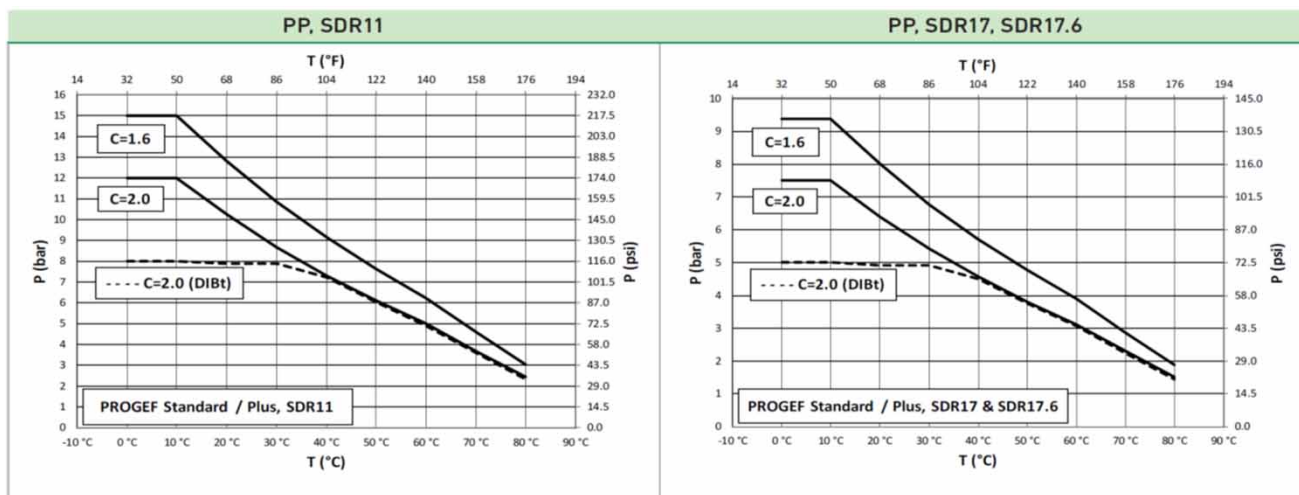

## PP-H tlakové trubky

36 506



### PP-H tlakové trubky DIN8077, SDR17,6 PN6

barva šedá RAL7032, délka 5m

d x e mm	PN bar	m kg/m	objednáací kód	cena Kč/m	cena EUR/m		sk
25 x 1,8	6		36 506 025	52,80	2,200		Z
32 x 1,9	6		36 506 032	78,00	3,250		Z
40 x 2,3	6		36 506 040	92,90	3,871		Z
50 x 2,9	6		36 506 050	123,00	5,125		Z
63 x 3,6	6		36 506 063	176,00	7,333		Z
75 x 4,3	6		36 506 075	247,00	10,292		Z
90 x 5,1	6		36 506 090	350,00	14,583		Z
110 x 6,3	6		36 506 110	485,00	20,208		Z
125 x 7,1	6		36 506 125	663,00	27,625		Z
140 x 8,0	6		36 506 140	810,00	33,750		Z
160 x 9,1	6		36 506 160	1 035,00	43,125		Z
180 x 10,2	6		36 506 180	1 373,00	57,208		Z
200 x 11,4	6		36 506 200	1 807,00	75,292		Z
225 x 12,8	6		36 506 225	2 144,00	89,333		Z
250 x 14,2	6		36 506 250	2 685,00	111,875		Z
280 x 15,9	6		36 506 280	3 296,00	137,333		Z
315 x 17,9	6		36 506 315	4 186,00	174,417		Z
355 x 20,1	6		36 506 355	6 237,00	259,875		Z
400 x 22,7	6		36 506 400	7 853,00	327,208		Z

36 510



### PP-H tlakové trubky DIN8077, SDR11 PN10

barva šedá RAL7032, délka 5m

d x e mm	PN bar	m kg/m	objednáací kód	cena Kč/m	cena EUR/m		sk
16 x 1,8	10		36 510 016	35,50	1,479		Z
20 x 1,9	10		36 510 020	40,10	1,671		Z
25 x 2,3	10		36 510 025	58,50	2,438		Z
32 x 3,0	10		36 510 032	78,00	3,250		Z
40 x 3,7	10		36 510 040	108,00	4,500		Z
50 x 4,6	10		36 510 050	157,00	6,542		Z
63 x 5,8	10		36 510 063	247,00	10,292		Z
75 x 6,9	10		36 510 075	349,00	14,542		Z
90 x 8,2	10		36 510 090	496,00	20,667		Z
110 x 10,0	10		36 510 110	733,00	30,542		Z
125 x 11,4	10		36 510 125	966,00	40,250		Z
140 x 12,8	10		36 510 140	1 215,00	50,625		Z
160 x 14,6	10		36 510 160	1 549,00	64,542		Z
180 x 16,4	10		36 510 180	2 107,00	87,792		Z
200 x 18,2	10		36 510 200	2 557,00	106,542		Z
225 x 20,5	10		36 510 225	3 251,00	135,458		Z
250 x 22,8	10		36 510 250	4 130,00	172,083		Z
280 x 25,5	10		36 510 280	4 982,00	207,583		Z
315 x 28,7	10		36 510 315	6 428,00	267,833		Z
355 x 32,3	10		36 510 355	9 750,00	406,250		Z
400 x 36,4	10		36 510 400	12 299,00	512,458		Z

## PP-H tvarovky polyfuzní

36 001



**koleno 90° polyfuzní**

d mm	PN bar	m kg	objednáací kód	cena Kč	cena EUR	balení [ks]		sk
						MB	VB	
16	10	0,015	36 001 016	74,00	3,083			H
20	10	0,020	36 001 020	79,00	3,292			H
25	10	0,029	36 001 025	89,00	3,708			H
32	10	0,050	36 001 032	103,00	4,292			H
40	10	0,076	36 001 040	132,00	5,500			H
50	10	0,127	36 001 050	247,00	10,292			H
63	10	0,230	36 001 063	308,00	12,833			H
75	10	0,317	36 001 075	660,00	27,500			H
90	10	0,512	36 001 090	812,00	33,833			H
110	10	0,874	36 001 110	1 211,00	50,458			H

36 005



**koleno 90° polyfuzní x vnitřní závit se zpevňujícím kroužkem**

d x Rp mm x inch	PN bar	m kg	objednáací kód	cena Kč	cena EUR	balení [ks]		sk
						MB	VB	
20 x 1/2"	10	0,022	36 005 020 012	156,00	6,500			H
25 x 3/4"	10	0,029	36 005 025 034	173,00	7,208			H
32 x 1"	10	0,054	36 005 032 100	220,00	9,167			H
40 x 5/4"	10	0,087	36 005 040 114	325,00	13,542			H

36 011



**koleno 45° polyfuzní**

d mm	PN bar	m kg	objednáací kód	cena Kč	cena EUR	balení [ks]		sk
						MB	VB	
16	10	0,008	36 011 016	96,00	4,000			H
20	10	0,016	36 011 020	106,00	4,417			H
25	10	0,024	36 011 025	118,00	4,917			H
32	10	0,036	36 011 032	132,00	5,500			H
40	10	0,059	36 011 040	159,00	6,625			H
50	10	0,084	36 011 050	217,00	9,042			H
63	10	0,185	36 011 063	278,00	11,583			H
75	10	0,234	36 011 075	577,00	24,042			H
90	10	0,405	36 011 090	771,00	32,125			H
110	10	0,657	36 011 110	1 231,00	51,292			H

36 040



**T-kus 90° polyfuzní**

d mm	PN bar	m kg	objednáací kód	cena Kč	cena EUR	balení [ks]		sk
						MB	VB	
16	10	0,019	36 040 016	83,00	3,458			H
20	10	0,027	36 040 020	89,00	3,708			H
25	10	0,038	36 040 025	94,00	3,917			H
32	10	0,058	36 040 032	110,00	4,583			H
40	10	0,094	36 040 040	132,00	5,500			H
50	10	0,158	36 040 050	236,00	9,833			H
63	10	0,288	36 040 063	330,00	13,750			H
75	10	0,380	36 040 075	735,00	30,625			H
90	10	0,739	36 040 090	1 203,00	50,125			H
110	10	1,070	36 040 110	1 529,00	63,708			H

36 045



**T-kus 90° polyfuzní x vnitřní závit se zpevňujícím kroužkem x polyfuzní**

d x Rp x d mm x inch x mm	PN bar	m kg	objednáací kód	cena Kč	cena EUR	balení [ks]		sk
						MB	VB	
20 x 1/2" x 20	10	0,030	36 045 020 012	223,00	9,292			H
25 x 3/4" x 25	10	0,042	36 045 025 034	281,00	11,708			H
32 x 1" x 32	10	0,069	36 045 032 100	281,00	11,708			H
40 x 5/4" x 40	10	0,107	36 045 040 114	388,00	16,167			H



## PP-H tvarovky polyfuzní

### 36 060



#### spojka polyfuzní

d mm	PN bar	m kg	objednáací kód	cena Kč	cena EUR	balení [ks]		sk
						MB	VB	
16	10	0,010	36 060 016	49,00	2,042			H
20	10	0,013	36 060 020	51,00	2,125			H
25	10	0,019	36 060 025	51,00	2,125			H
32	10	0,026	36 060 032	68,00	2,833			H
40	10	0,042	36 060 040	83,00	3,458			H
50	10	0,075	36 060 050	152,00	6,333			H
63	10	0,129	36 060 063	231,00	9,625			H
75	10	0,144	36 060 075	320,00	13,333			H
90	10	0,257	36 060 090	459,00	19,125			H
110	10	0,405	36 060 110	723,00	30,125			H

### 36 063



#### reduktce polyfuzní vnější x vnitřní

d x d mm x mm	PN bar	m kg	objednáací kód	cena Kč	cena EUR	balení [ks]		sk
						MB	VB	
20 x 16	10	0,009	36 063 020 016	59,00	2,458			H
25 x 16	10	0,010	36 063 025 016	74,00	3,083			H
25 x 20	10	0,014	36 063 025 020	74,00	3,083			H
32 x 20	10	0,016	36 063 032 020	89,00	3,708			H
32 x 25	10	0,020	36 063 032 025	89,00	3,708			H
40 x 20	10	0,022	36 063 040 020	100,00	4,167			H
40 x 25	10	0,026	36 063 040 025	100,00	4,167			H
40 x 32	10	0,031	36 063 040 032	100,00	4,167			H
50 x 20	10	0,034	36 063 050 020	137,00	5,708			H
50 x 25	10	0,035	36 063 050 025	137,00	5,708			H
50 x 32	10	0,040	36 063 050 032	137,00	5,708			H
50 x 40	10	0,047	36 063 050 040	137,00	5,708			H
63 x 25	10	0,058	36 063 063 025	159,00	6,625			H
63 x 32	10	0,061	36 063 063 032	159,00	6,625			H
63 x 40	10	0,068	36 063 063 040	159,00	6,625			H
63 x 50	10	0,082	36 063 063 050	159,00	6,625			H
75 x 63	10	0,098	36 063 075 063	284,00	11,833			H
90 x 63	10	0,181	36 063 090 063	396,00	16,500			H
90 x 75	10	0,134	36 063 090 075	396,00	16,500			H
110 x 90	10	0,247	36 063 110 090	540,00	22,500			H

### 36 073



#### přechodová spojka polyfuzní x vnitřní závit se zpevňujícím kroužkem

d x Rp mm x inch	PN bar	m kg	objednáací kód	cena Kč	cena EUR	balení [ks]		sk
						MB	VB	
20 x 3/8"	10	0,017	36 073 020 038	118,00	4,917			H
20 x 1/2"	10	0,017	36 073 020 012	119,00	4,958			H
25 x 3/4"	10	0,023	36 073 025 034	146,00	6,083			H
32 x 1"	10	0,038	36 073 032 100	181,00	7,542			H
40 x 5/4"	10	0,056	36 073 040 114	223,00	9,292			H
50 x 6/4"	10	0,089	36 073 050 112	366,00	15,250			H
63 x 2"	10	0,137	36 073 063 200	454,00	18,917			H

### 36 076



#### přechod polyfuzní vnější x vnitřní závit se zpevňujícím kroužkem

d x Rp mm x inch	PN bar	m kg	objednáací kód	cena Kč	cena EUR	balení [ks]		sk
						MB	VB	
20 x 1/4"	10	0,008	36 076 020 014	158,00	6,583			H
20 x 3/8"	10	0,011	36 076 020 038	158,00	6,583			H
25 x 1/2"	10	0,015	36 076 025 012	173,00	7,208			H
32 x 3/4"	10	0,023	36 076 032 034	214,00	8,917			H
40 x 1"	10	0,039	36 076 040 100	259,00	10,792			H
50 x 5/4"	10	0,061	36 076 050 114	363,00	15,125			H

## PP-H tvarovky polyfuzní

36 078



**přechod** polyfuzní vnější x vnější závit

d x R mm x inch	PN bar	m kg	objednáací kód	cena Kč	cena EUR	balení [ks]		sk
						MB	VB	
16 x 3/8"	10	0,008	36 078 016 038	140,00	5,833			H
20 x 1/2"	10	0,012	36 078 020 012	140,00	5,833			H
25 x 3/4"	10	0,016	36 078 025 034	156,00	6,500			H
32 x 1"	10	0,027	36 078 032 100	209,00	8,708			H
40 x 5/4"	10	0,041	36 078 040 114	450,00	18,750			H
50 x 6/4"	10	0,062	36 078 050 112	496,00	20,667			H
63 x 2"	10	0,100	36 078 063 200	673,00	28,042			H

36 100



**hadicový trn** polyfuzní

d x d mm x mm	PN bar	m kg	objednáací kód	cena Kč	cena EUR	balení [ks]		sk
						MB	VB	
20 x 20	10	0,009	36 100 020	120,00	5,000			H
25 x 25	10	0,015	36 100 025	152,00	6,333			H
32 x 32	10	0,026	36 100 032	181,00	7,542			H
40 x 40	10	0,040	36 100 040	310,00	12,917			H
50 x 50	10	0,061	36 100 050	483,00	20,125			H
63 x 60	10	0,096	36 100 063	501,00	20,875			H

36 105



**víčko** polyfuzní

d mm	PN bar	m kg	objednáací kód	cena Kč	cena EUR	balení [ks]		sk
						MB	VB	
16	10	0,006	36 105 016	72,00	3,000			H
20	10	0,010	36 105 020	74,00	3,083			H
25	10	0,015	36 105 025	82,00	3,417			H
32	10	0,024	36 105 032	83,00	3,458			H
40	10	0,036	36 105 040	106,00	4,417			H
50	10	0,061	36 105 050	143,00	5,958			H
63	10	0,098	36 105 063	202,00	8,417			H
75	10	0,146	36 105 075	332,00	13,833			H
90	10	0,273	36 105 090	417,00	17,375			H
110	10	0,417	36 105 110	553,00	23,042			H

36 152



**lemový nákrůžek** polyfuzní

d mm	PN bar	m kg	objednáací kód	cena Kč	cena EUR	balení [ks]		sk
						MB	VB	
20	10	0,011	36 152 020	74,00	3,083			H
25	10	0,022	36 152 025	77,00	3,208			H
32	10	0,033	36 152 032	77,00	3,208			H
40	10	0,046	36 152 040	91,00	3,792			H
50	10	0,062	36 152 050	101,00	4,208			H
63	10	0,090	36 152 063	140,00	5,833			H
75	10	0,163	36 152 075	281,00	11,708			H
90	10	0,233	36 152 090	463,00	19,292			H
110	10	0,319	36 152 110	660,00	27,500			H

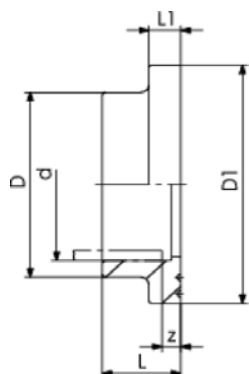

d mm		D mm	D1 mm			L mm	Z mm	L1 mm
20		27	45			19	5	7
25		33	58			21	5	9
32		41	68			23	5	10
40		50	78			25	5	11
50		61	88			28	5	12
63		76	102			32	5	14
75		90	122			36	5	16
90		108	138			42	7	17
110		131	158			48	7	18

40 160/163



příruba PP-V pro polyfuzní lemové nákrůžky

d/DN mm	PN bar	m kg	objednáací kód	cena Kč	cena EUR	balení [ks]		sk
						MB	VB	
20/15	16	0,080	40 160 020	202,40	8,433			D
25/20	16	0,100	40 160 025	227,90	9,496			D
32/25	16	0,140	40 160 032	291,80	12,158			D
40/32	16	0,220	40 160 040	343,80	14,325			D
50/40	16	0,210	40 160 050	408,60	17,025			D
63/50	16	0,380	40 160 063	512,80	21,367			D
75/65	16	0,480	40 160 075	573,70	23,904			D
90/80	16	0,520	40 163 090	683,70	28,488			D
110/100	16	0,680	40 163 110	841,90	35,079			D

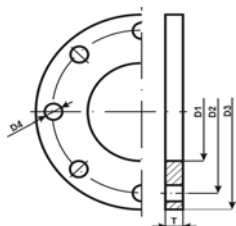

d/DN mm		D1 mm	D2 mm	D3 mm		počet děr	D4 mm	T mm
20/15		28	65	95		4	14	16
25/20		34	75	105		4	14	17
32/25		42	85	115		4	14	18
40/32		51	100	140		4	18	20
50/40		62	110	150		4	18	22
63/50		78	125	165		4	18	24
75/65		92	145	185		4	18	26
90/80		110	160	200		8	18	27
110/100		133	180	220		8	18	28

35 002



EPDM gumokovové těsnění pro přírubové spoje

d/DN mm	PN bar	m kg	objednáací kód	cena Kč	cena EUR	balení [ks]		sk
						MB	VB	
20/15	10		35 002 020	0,00	0,000			C
25/20	10		35 002 025	0,00	0,000			C
32/25	10		35 002 032	238,00	9,917			C
40/32	10		35 002 040	245,00	10,208			C
50/40	10		35 002 050	246,00	10,250			C
63/50	10		35 002 063	266,00	11,083			C
75/65	10		35 002 075	285,00	11,875			C
90/80	10		35 002 090	298,00	12,417			C
110/100	10		35 002 110	314,00	13,083			C

35 003



FPM gumokovové těsnění pro přírubové spoje

d/DN mm	PN bar	m kg	objednáací kód	cena Kč	cena EUR	balení [ks]		sk
						MB	VB	
20/15	10		35 003 020	0,00	0,000			E
25/20	10		35 003 025	0,00	0,000			E
32/25	10		35 003 032	1 051,00	43,792			E
40/32	10		35 003 040	1 088,00	45,333			E
50/40	10		35 003 050	1 126,00	46,917			E
63/50	10		35 003 063	1 198,00	49,917			E
75/65	10		35 003 075	1 272,00	53,000			E
90/80	10		35 003 090	1 361,00	56,708			E
110/100	10		35 003 110	1 393,00	58,042			E

d/DN mm			D1 mm	D2 mm	tl. mm			
20/15			20	51	3/4			
25/20			22	61	3/4			
32/25			28	71	3/4			
40/32			40	82	3/4			
50/40			46	92	3/4			
63/50			58	107	4/5			
75/65			69	127	4/5			
90/80			84	142	4/5			
110/100			104	162	5/6			

36 110



šroubení EPDM polyfuzní

d mm	PN bar	m kg	objednáací kód	cena Kč	cena EUR	balení [ks]		sk
						MB	VB	
16	10	0,020	36 110 016	363,00	15,125			H
20	10	0,038	36 110 020	378,00	15,750			H
25	10	0,062	36 110 025	411,00	17,125			H
32	10	0,079	36 110 032	495,00	20,625			H
40	10	0,137	36 110 040	660,00	27,500			H
50	10	0,180	36 110 050	926,00	38,583			H
63	10	0,312	36 110 063	1 317,00	54,875			H
75	10	0,450	36 110 075	2 001,00	83,375			H
90	10	0,645	36 110 090	2 639,00	109,958			H
110	10	1,020	36 110 110	3 533,00	147,208			H

36 111



šroubení FPM polyfuzní

d mm	PN bar	m kg	objednáací kód	cena Kč	cena EUR	balení [ks]		sk
						MB	VB	
16	10	0,020	36 111 016	419,00	17,458			H
20	10	0,038	36 111 020	443,00	18,458			H
25	10	0,062	36 111 025	496,00	20,667			H
32	10	0,079	36 111 032	585,00	24,375			H
40	10	0,137	36 111 040	821,00	34,208			H
50	10	0,180	36 111 050	1 098,00	45,750			H
63	10	0,312	36 111 063	1 517,00	63,208			H
75	10	0,450	36 111 075	2 379,00	99,125			H
90	10	0,645	36 111 090	3 025,00	126,042			H
110	10	1,020	36 111 110	4 338,00	180,750			H

36 120



O-kroužek pro šroubení EPDM

d mm	PN bar	m kg	objednáací kód	cena Kč	cena EUR	D1 mm	D2 mm	sk
20	10	0,002	36 120 020	43,00	1,792	20,2	3,5	H
25	10	0,002	36 120 025	43,00	1,792	28,2	3,5	H
32	10	0,002	36 120 032	86,00	3,583	32,9	3,5	H
40	10	0,006	36 120 040	86,00	3,583	40,6	5,3	H
50	10	0,007	36 120 050	86,00	3,583	47,0	5,3	H
63	10	0,010	36 120 063	88,00	3,667	59,7	5,3	H
75	10	0,012	36 120 075	114,00	4,750	81,9	5,3	H
90	10	0,015	36 120 090	189,00	7,875	101,0	5,3	H
110	10	0,031	36 120 110	200,00	8,333	120,0	7,0	H

36 121



O-kroužek pro šroubení FPM

d mm	PN bar	m kg	objednáací kód	cena Kč	cena EUR	D1 mm	D2 mm	sk
20	10	0,002	36 121 020	117,00	4,875	20,2	3,5	H
25	10	0,002	36 121 025	138,00	5,750	28,2	3,5	H
32	10	0,002	36 121 032	163,00	6,792	32,9	3,5	H
40	10	0,006	36 121 040	260,00	10,833	40,6	5,3	H
50	10	0,007	36 121 050	284,00	11,833	47,0	5,3	H
63	10	0,010	36 121 063	326,00	13,583	59,7	5,3	H
75	10	0,012	36 121 075	513,00	21,375	81,9	5,3	H
90	10	0,015	36 121 090	613,00	25,542	101,0	5,3	H
110	10	0,031	36 121 110	1 121,00	46,708	120,0	7,0	H

## PP-H tvarovky

### 36 122



#### vložný díl do šroubení polyfuzní

d mm	PN bar	m kg	objednáací kód	cena Kč	cena EUR	balení [ks]		sk
						MB	VB	
16	10	0,004	36 122 016	41,00	1,708			H
20	10	0,006	36 122 020	46,00	1,917			H
25	10	0,011	36 122 025	52,00	2,167			H
32	10	0,014	36 122 032	58,00	2,417			H
40	10	0,025	36 122 040	76,00	3,167			H
50	10	0,024	36 122 050	90,00	3,750			H
63	10	0,042	36 122 063	93,00	3,875			H
75	10	0,085	36 122 075	415,00	17,292			H
90	10	0,130	36 122 090	526,00	21,917			H
110	10	0,220	36 122 110	643,00	26,792			H

### 36 123



#### převlečná matice na šroubení

d mm	PN bar	m kg	objednáací kód	cena Kč	cena EUR	balení [ks]		sk
						MB	VB	
16	10	0,008	36 123 016	157,00	6,542			H
20	10	0,021	36 123 020	179,00	7,458			H
25	10	0,034	36 123 025	184,00	7,667			H
32	10	0,042	36 123 032	221,00	9,208			H
40	10	0,068	36 123 040	300,00	12,500			H
50	10	0,100	36 123 050	453,00	18,875			H
63	10	0,168	36 123 063	730,00	30,417			H
75	10	0,205	36 123 075	913,00	38,042			H
90	10	0,288	36 123 090	1 095,00	45,625			H
110	10	0,460	36 123 110	1 410,00	58,750			H

### 36 112



#### šroubení EPDM závitové

G inch	PN bar	m kg	objednáací kód	cena Kč	cena EUR	balení [ks]		sk
						MB	VB	
1"	10	0,080	36 112 100	181,30	7,252		120	E

### 36 108



#### zátka závitová

G inch	PN bar	m kg	objednáací kód	cena Kč	cena EUR	balení [ks]		sk
						MB	VB	
5/4"	10	0,040	36 108 114	77,30	3,221		350	E

## PP-H tvarovky na tupo

### 36 020



#### oblouk 90° SDR11 na tupo

d mm	PN bar	m kg	objednáací kód	cena Kč	cena EUR	balení [ks]		sk
						MB	VB	
20	10		36 020 020	83,00	3,458			H
25	10		36 020 025	89,00	3,708			H
32	10		36 020 032	67,00	2,792			H
40	10		36 020 040	119,00	4,958			H
50	10		36 020 050	150,00	6,250			H
63	10		36 020 063	158,00	6,583			H
75	10		36 020 075	312,00	13,000			H
90	10		36 020 090	442,00	18,417			H
110	10		36 020 110	842,00	35,083			H
125	10		36 020 125	1 198,00	49,917			H
140	10		36 020 140	1 514,00	63,083			H
160	10		36 020 160	1 871,00	77,958			H
180	10		36 020 180	2 221,00	92,542			H
200	10		36 020 200	3 343,00	139,292			H
225	10		36 020 225	4 205,00	175,208			H
250	10		36 020 250	8 227,00	342,792			H
280	10		36 020 280	10 717,00	446,542			H
315	10		36 020 315	14 809,00	617,042			H
355	10		36 020 355	24 898,00	1 037,417			H
400	10		36 020 400	35 610,00	1 483,750			H

### 36 021



#### oblouk 90° SDR17,6 na tupo

d mm	PN bar	m kg	objednáací kód	cena Kč	cena EUR	balení [ks]		sk
						MB	VB	
50	6		36 021 050	159,00	6,625			H
63	6		36 021 063	220,00	9,167			H
75	6		36 021 075	300,00	12,500			H
90	6		36 021 090	393,00	16,375			H
110	6		36 021 110	823,00	34,292			H
125	6		36 021 125	1 035,00	43,125			H
140	6		36 021 140	1 448,00	60,333			H
160	6		36 021 160	1 622,00	67,583			H
180	6		36 021 180	1 968,00	82,000			H
200	6		36 021 200	2 504,00	104,333			H
225	6		36 021 225	3 206,00	133,583			H
250	6		36 021 250	5 603,00	233,458			H
280	6		36 021 280	7 292,00	303,833			H
315	6		36 021 315	10 049,00	418,708			H
355	6		36 021 355	19 149,00	797,875			H
400	6		36 021 400	25 566,00	1 065,250			H

### 36 012



#### koleno 45° SDR11 na tupo

d mm	PN bar	m kg	objednáací kód	cena Kč	cena EUR	balení [ks]		sk
						MB	VB	
20	10		36 012 020	121,00	5,042			H
25	10		36 012 025	129,00	5,375			H
32	10		36 012 032	156,00	6,500			H
40	10		36 012 040	197,00	8,208			H
50	10		36 012 050	223,00	9,292			H
63	10		36 012 063	369,00	15,375			H
75	10		36 012 075	518,00	21,583			H
90	10		36 012 090	641,00	26,708			H
110	10		36 012 110	1 180,00	49,167			H
125	10		36 012 125	1 678,00	69,917			H
140	10		36 012 140	2 366,00	98,583			H
160	10		36 012 160	2 557,00	106,542			H
180	10		36 012 180	0,00	0,000			H
200	10		36 012 200	3 958,00	164,917			H
225	10		36 012 225	4 493,00	187,208			H
250	10		36 012 250	10 479,00	436,625			H
280	10		36 012 280	15 810,00	658,750			H
315	10		36 012 315	19 195,00	799,792			H

## PP-H tvarovky na tupo

### 36 013



#### koleno 45° SDR17,6 na tupo

d mm	PN bar	m kg	objednáací kód	cena Kč	cena EUR	balení [ks]		sk
						MB	VB	
50	6		36 013 050	209,00	8,708			H
63	6		36 013 063	369,00	15,375			H
75	6		36 013 075	490,00	20,417			H
90	6		36 013 090	620,00	25,833			H
110	6		36 013 110	1 180,00	49,167			H
125	6		36 013 125	1 678,00	69,917			H
140	6		36 013 140	2 366,00	98,583			H
160	6		36 013 160	2 557,00	106,542			H
180	6		36 013 180	0,00	0,000			H
200	6		36 013 200	3 958,00	164,917			H
225	6		36 013 225	4 493,00	187,208			H
250	6		36 013 250	9 016,00	375,667			H
280	6		36 013 280	13 864,00	577,667			H
315	6		36 013 315	16 931,00	705,458			H

### 36 041



#### T-kus 90° SDR11 na tupo

d mm	PN bar	m kg	objednáací kód	cena Kč	cena EUR	balení [ks]		sk
						MB	VB	
20	10		36 041 020	72,00	3,000			H
25	10		36 041 025	74,00	3,083			H
32	10		36 041 032	83,00	3,458			H
40	10		36 041 040	150,00	6,250			H
50	10		36 041 050	203,00	8,458			H
63	10		36 041 063	292,00	12,167			H
75	10		36 041 075	595,00	24,792			H
90	10		36 041 090	846,00	35,250			H
110	10		36 041 110	1 231,00	51,292			H
125	10		36 041 125	1 859,00	77,458			H
140	10		36 041 140	2 373,00	98,875			H
160	10		36 041 160	4 047,00	168,625			H
180	10		36 041 180	5 247,00	218,625			H
200	10		36 041 200	6 270,00	261,250			H
225	10		36 041 225	8 181,00	340,875			H
250	10		36 041 250	10 943,00	455,958			H
280	10		36 041 280	14 050,00	585,417			H
315	10		36 041 315	19 964,00	831,833			H
355	10		36 041 355	28 855,00	1 202,292			H
400	10		36 041 400	43 909,00	1 829,542			H

### 36 042



#### T-kus 90° SDR17,6 na tupo

d mm	PN bar	m kg	objednáací kód	cena Kč	cena EUR	balení [ks]		sk
						MB	VB	
50	6		36 042 050	163,00	6,792			H
63	6		36 042 063	263,00	10,958			H
75	6		36 042 075	460,00	19,167			H
90	6		36 042 090	643,00	26,792			H
110	6		36 042 110	1 048,00	43,667			H
125	6		36 042 125	1 594,00	66,417			H
140	6		36 042 140	1 892,00	78,833			H
160	6		36 042 160	3 611,00	150,458			H
180	6		36 042 180	4 669,00	194,542			H
200	6		36 042 200	5 115,00	213,125			H
225	6		36 042 225	6 863,00	285,958			H
250	6		36 042 250	9 181,00	382,542			H
280	6		36 042 280	10 293,00	428,875			H
315	6		36 042 315	13 632,00	568,000			H
355	6		36 042 355	21 910,00	912,917			H
400	6		36 042 400	33 929,00	1 413,708			H

## PP-H tvarovky na tupo

### 36 043



#### T-kus 90° SDR11 redukovany, na tupo

d x d mm	PN bar	m kg	objednací kód	cena Kč	cena EUR	balení [ks]		sk
						MB	VB	
63 x 32	10		36 043 063 032	501,00	20,875			H
63 x 50	10		36 043 063 050	501,00	20,875			H
75 x 32	10		36 043 075 032	723,00	30,125			H
75 x 50	10		36 043 075 050	723,00	30,125			H
75 x 63	10		36 043 075 063	723,00	30,125			H
90 x 50	10		36 043 090 050	903,00	37,625			H
90 x 63	10		36 043 090 063	1 026,00	42,750			H
90 x 75	10		36 043 090 075	1 026,00	42,750			H
110 x 32	10		36 043 110 032	1 297,00	54,042			H
110 x 50	10		36 043 110 050	1 327,00	55,292			H
110 x 63	10		36 043 110 063	1 451,00	60,458			H
110 x 75	10		36 043 110 075	1 500,00	62,500			H
110 x 90	10		36 043 110 090	1 500,00	62,500			H
160 x 63	10		36 043 160 063	3 845,00	160,208			H
160 x 75	10		36 043 160 075	3 874,00	161,417			H
160 x 90	10		36 043 160 090	3 874,00	161,417			H
160 x 110	10		36 043 160 110	3 932,00	163,833			H
225 x 90	10		36 043 225 090	8 896,00	370,667			H
225 x 110	10		36 043 225 110	8 896,00	370,667			H
225 x 160	10		36 043 225 160	8 984,00	374,333			H

### 36 044



#### T-kus 90° SDR17,6 redukovany, na tupo

d x d mm	PN bar	m kg	objednací kód	cena Kč	cena EUR	balení [ks]		sk
						MB	VB	
63 x 32 SDR11	6		36 044 063 032	480,00	20,000			H
63 x 50	6		36 044 063 050	480,00	20,000			H
75 x 32 SDR11	6		36 044 075 032	723,00	30,125			H
75 x 50	6		36 044 075 050	723,00	30,125			H
75 x 63	6		36 044 075 063	753,00	31,375			H
90 x 50	6		36 044 090 050	963,00	40,125			H
90 x 63	6		36 044 090 063	963,00	40,125			H
90 x 75	6		36 044 090 075	1 026,00	42,750			H
110 x 32 SDR11	6		36 044 110 032	1 360,00	56,667			H
110 x 50	6		36 044 110 050	1 417,00	59,042			H
110 x 63	6		36 044 110 063	1 297,00	54,042			H
110 x 75	6		36 044 110 075	1 417,00	59,042			H
110 x 90	6		36 044 110 090	1 417,00	59,042			H
160 x 63	6		36 044 160 063	3 498,00	145,750			H
160 x 75	6		36 044 160 075	3 559,00	148,292			H
160 x 90	6		36 044 160 090	3 559,00	148,292			H
160 x 110	6		36 044 160 110	3 586,00	149,417			H
225 x 90	6		36 044 225 090	8 450,00	352,083			H
225 x 110	6		36 044 225 110	8 450,00	352,083			H
225 x 160	6		36 044 225 160	8 538,00	355,750			H



## PP-H tvarovky na tupo

36 064



redukce SDR11 na tupo

d x d mm	PN bar	m kg	objednáací kód	cena Kč	cena EUR	balení [ks]		sk
						MB	VB	
25 x 20	10		36 064 025 020	119,00	4,958			H
32 x 20	10		36 064 032 020	147,00	6,125			H
32 x 25	10		36 064 032 025	147,00	6,125			H
40 x 20	10		36 064 040 020	164,00	6,833			H
40 x 25	10		36 064 040 025	164,00	6,833			H
40 x 32	10		36 064 040 032	164,00	6,833			H
50 x 25	10		36 064 050 025	169,00	7,042			H
50 x 32	10		36 064 050 032	169,00	7,042			H
50 x 40	10		36 064 050 040	169,00	7,042			H
63 x 32	10		36 064 063 032	202,00	8,417			H
63 x 40	10		36 064 063 040	202,00	8,417			H
63 x 50	10		36 064 063 050	202,00	8,417			H
75 x 40	10		36 064 075 040	270,00	11,250			H
75 x 50	10		36 064 075 050	270,00	11,250			H
75 x 63	10		36 064 075 063	270,00	11,250			H
90 x 63	10		36 064 090 063	288,00	12,000			H
90 x 75	10		36 064 090 075	288,00	12,000			H
110 x 75	10		36 064 110 075	360,00	15,000			H
110 x 90	10		36 064 110 090	360,00	15,000			H
125 x 110	10		36 064 125 110	465,00	19,375			H
140 x 110	10		36 064 140 110	577,00	24,042			H
140 x 125	10		36 064 140 125	577,00	24,042			H
160 x 110	10		36 064 160 110	670,00	27,917			H
160 x 140	10		36 064 160 140	660,00	27,500			H
180 x 90	10		36 064 180 090	1 160,00	48,333			H
180 x 110	10		36 064 180 110	1 056,00	44,000			H
180 x 125	10		36 064 180 125	963,00	40,125			H
180 x 140	10		36 064 180 140	1 023,00	42,625			H
180 x 160	10		36 064 180 160	908,00	37,833			H
200 x 160	10		36 064 200 160	2 425,00	101,042			H
200 x 180	10		36 064 200 180	2 227,00	92,792			H
225 x 110	10		36 064 225 110	3 063,00	127,625			H
225 x 160	10		36 064 225 160	2 561,00	106,708			H
225 x 180	10		36 064 225 180	2 823,00	117,625			H
225 x 200	10		36 064 225 200	2 154,00	89,750			H
250 x 160	10		36 064 250 160	3 442,00	143,417			H
250 x 225	10		36 064 250 225	2 767,00	115,292			H
280 x 225	10		36 064 280 225	2 767,00	115,292			H
280 x 250	10		36 064 280 250	3 589,00	149,542			H
315 x 225	10		36 064 315 225	4 223,00	175,958			H
315 x 250	10		36 064 315 250	4 280,00	178,333			H
315 x 280	10		36 064 315 280	4 164,00	173,500			H
355 x 250	10		36 064 355 250	11 428,00	476,167			H
355 x 280	10		36 064 355 280	10 626,00	442,750			H
355 x 315	10		36 064 355 315	10 274,00	428,083			H
400 x 315	10		36 064 400 315	31 790,00	1 324,583			H
400 x 355	10		36 064 400 355	23 647,00	985,292			H

## PP-H tvarovky na tupo

### 36 065



#### redukcce SDR17,6 na tupo

d x d mm	PN bar	m kg	objednáací kód	cena Kč	cena EUR	balení [ks]		sk
						MB	VB	
50 x 40	6		36 065 050 040	156,00	6,500			H
63 x 40	6		36 065 063 040	198,00	8,250			H
63 x 50	6		36 065 063 050	203,00	8,458			H
75 x 40	6		36 065 075 040	270,00	11,250			H
75 x 50	6		36 065 075 050	270,00	11,250			H
75 x 63	6		36 065 075 063	259,00	10,792			H
90 x 63	6		36 065 090 063	289,00	12,042			H
90 x 75	6		36 065 090 075	289,00	12,042			H
110 x 75	6		36 065 110 075	346,00	14,417			H
110 x 90	6		36 065 110 090	360,00	15,000			H
125 x 110	6		36 065 125 110	465,00	19,375			H
140 x 110	6		36 065 140 110	577,00	24,042			H
140 x 125	6		36 065 140 125	577,00	24,042			H
160 x 110	6		36 065 160 110	687,00	28,625			H
160 x 140	6		36 065 160 140	687,00	28,625			H
180 x 90	6		36 065 180 090	1 441,00	60,042			H
180 x 110	6		36 065 180 110	1 441,00	60,042			H
180 x 125	6		36 065 180 125	1 501,00	62,542			H
180 x 140	6		36 065 180 140	1 391,00	57,958			H
180 x 160	6		36 065 180 160	878,00	36,583			H
200 x 160	6		36 065 200 160	2 047,00	85,292			H
200 x 180	6		36 065 200 180	2 149,00	89,542			H
225 x 110	6		36 065 225 110	3 296,00	137,333			H
225 x 160	6		36 065 225 160	2 482,00	103,417			H
225 x 180	6		36 065 225 180	2 646,00	110,250			H
225 x 200	6		36 065 225 200	2 081,00	86,708			H
250 x 160	6		36 065 250 160	3 436,00	143,167			H
250 x 225	6		36 065 250 225	2 793,00	116,375			H
280 x 225	6		36 065 280 225	3 589,00	149,542			H
280 x 250	6		36 065 280 250	3 254,00	135,583			H
315 x 225	6		36 065 315 225	4 075,00	169,792			H
315 x 250	6		36 065 315 250	3 788,00	157,833			H
315 x 280	6		36 065 315 280	3 888,00	162,000			H
355 x 280	6		36 065 355 280	10 804,00	450,167			H
355 x 315	6		36 065 355 315	10 469,00	436,208			H
400 x 315	6		36 065 400 315	27 922,00	1 163,417			H
400 x 355	6		36 065 400 355	18 019,00	750,792			H

### 36 074



#### přechod SDR11 na tupo s vnitřním závitem se zpevňujícím kroužkem

d x Rp mm x inch	PN bar	m kg	objednáací kód	cena Kč	cena EUR	balení [ks]		sk
						MB	VB	
20 x 1/2"	10	0,017	36 074 020 012	218,00	9,083			H
25 x 3/4"	10	0,022	36 074 025 034	258,00	10,750			H
32 x 1"	10	0,038	36 074 032 100	320,00	13,333			H
40 x 5/4"	10	0,066	36 074 040 114	366,00	15,250			H
50 x 6/4"	10	0,090	36 074 050 112	577,00	24,042			H
63 x 2"	10	0,140	36 074 063 200	670,00	27,917			H

### 36 077



#### přechod SDR11 na tupo s vnějším závitem

d x R mm x inch	PN bar	m kg	objednáací kód	cena Kč	cena EUR	balení [ks]		sk
						MB	VB	
20 x 1/2"	10	0,013	36 077 020 012	169,00	7,042			H
25 x 3/4"	10	0,026	36 077 025 034	203,00	8,458			H
32 x 1"	10	0,028	36 077 032 100	258,00	10,750			H
40 x 5/4"	10	0,041	36 077 040 114	308,00	12,833			H
50 x 6/4"	10	0,062	36 077 050 112	501,00	20,875			H
63 x 2"	10	0,096	36 077 063 200	633,00	26,375			H

## PP-H tvarovky na tupo

### 36 101



#### hadicový trn SDR11 na tupo

d x d mm	PN bar	m kg	objednáací kód	cena Kč	cena EUR	balení [ks]		sk
						MB	VB	
20 x 20	10	0,008	36 101 020	133,00	5,542			H
25 x 25	10	0,012	36 101 025	173,00	7,208			H
32 x 32	10	0,022	36 101 032	209,00	8,708			H
40 x 40	10	0,030	36 101 040	310,00	12,917			H
50 x 50	10	0,060	36 101 050	521,00	21,708			H
63 x 60	10	0,095	36 101 063	609,00	25,375			H

### 36 106



#### víčko SDR11 na tupo

d mm	PN bar	m kg	objednáací kód	cena Kč	cena EUR	balení [ks]		sk
						MB	VB	
20	10		36 106 020	143,00	5,958			H
25	10		36 106 025	178,00	7,417			H
32	10		36 106 032	226,00	9,417			H
40	10		36 106 040	278,00	11,583			H
50	10		36 106 050	360,00	15,000			H
63	10		36 106 063	473,00	19,708			H
75	10		36 106 075	735,00	30,625			H
90	10		36 106 090	1 113,00	46,375			H
110	10		36 106 110	1 352,00	56,333			H
125	10		36 106 125	1 478,00	61,583			H
140	10		36 106 140	1 757,00	73,208			H
160	10		36 106 160	2 011,00	83,792			H
180	10		36 106 180	2 319,00	96,625			H
200	10		36 106 200	2 556,00	106,500			H
225	10		36 106 225	3 098,00	129,083			H
250	10		36 106 250	3 816,00	159,000			H
280	10		36 106 280	5 167,00	215,292			H
315	10		36 106 315	7 058,00	294,083			H
355	10		36 106 355	11 466,00	477,750			H
400	10		36 106 400	21 111,00	879,625			H

### 36 107



#### víčko SDR17,6 na tupo

d mm	PN bar	m kg	objednáací kód	cena Kč	cena EUR	balení [ks]		sk
						MB	VB	
50	6		36 107 050	347,00	14,458			H
63	6		36 107 063	473,00	19,708			H
75	6		36 107 075	735,00	30,625			H
90	6		36 107 090	1 113,00	46,375			H
110	6		36 107 110	1 352,00	56,333			H
125	6		36 107 125	1 478,00	61,583			H
140	6		36 107 140	1 791,00	74,625			H
160	6		36 107 160	2 011,00	83,792			H
180	6		36 107 180	2 268,00	94,500			H
200	6		36 107 200	2 556,00	106,500			H
225	6		36 107 225	3 098,00	129,083			H
250	6		36 107 250	3 662,00	152,583			H
280	6		36 107 280	5 167,00	215,292			H
315	6		36 107 315	7 058,00	294,083			H
355	6		36 107 355	11 466,00	477,750			H
400	6		36 107 400	20 244,00	843,500			H

### 36 114



#### šroubení SDR11 EPDM na tupo

d mm	PN bar	m kg	objednáací kód	cena Kč	cena EUR	balení [ks]		sk
						MB	VB	
20	10		36 114 020	443,00	18,458			H
25	10		36 114 025	550,00	22,917			H
32	10		36 114 032	566,00	23,583			H
40	10		36 114 040	803,00	33,458			H
50	10		36 114 050	1 000,00	41,667			H
63	10		36 114 063	1 317,00	54,875			H
75	10		36 114 075	2 108,00	87,833			H
90	10		36 114 090	2 466,00	102,750			H
110	10		36 114 110	3 188,00	132,833			H

## PP-H tvarovky na tupo

### 36 115



#### šroubení SDR11 FPM na tupo

d mm	PN bar	m kg	objednáací kód	cena Kč	cena EUR	balení [ks]		sk
						MB	VB	
20	10		36 115 020	496,00	20,667			H
25	10		36 115 025	620,00	25,833			H
32	10		36 115 032	629,00	26,208			H
40	10		36 115 040	946,00	39,417			H
50	10		36 115 050	1 158,00	48,250			H
63	10		36 115 063	1 494,00	62,250			H
75	10		36 115 075	2 475,00	103,125			H
90	10		36 115 090	2 722,00	113,417			H
110	10		36 115 110	3 403,00	141,792			H

### 36 116



#### šroubení SDR17,6 EPDM na tupo

d mm	PN bar	m kg	objednáací kód	cena Kč	cena EUR	balení [ks]		sk
						MB	VB	
75	6		36 116 075	2 074,00	86,417			H
90	6		36 116 090	2 413,00	100,542			H
110	6		36 116 110	2 966,00	123,583			H

### 36 117



#### šroubení SDR17,6 FPM na tupo

d mm	PN bar	m kg	objednáací kód	cena Kč	cena EUR	balení [ks]		sk
						MB	VB	
75	6		36 117 075	2 441,00	101,708			H
90	6		36 117 090	3 086,00	128,583			H
110	6		36 117 110	3 323,00	138,458			H

### 36 124



#### vložný díl do šroubení SDR11 na tupo

d mm	PN bar	m kg	objednáací kód	cena Kč	cena EUR	balení [ks]		sk
						MB	VB	
20	10		36 124 020	119,00	4,958			H
25	10		36 124 025	150,00	6,250			H
32	10		36 124 032	150,00	6,250			H
40	10		36 124 040	246,00	10,250			H
50	10		36 124 050	246,00	10,250			H
63	10		36 124 063	271,00	11,292			H
75	10		36 124 075	397,00	16,542			H
90	10		36 124 090	480,00	20,000			H
110	10		36 124 110	666,00	27,750			H

### 36 125



#### vložný díl do šroubení SDR17,6 na tupo

d mm	PN bar	m kg	objednáací kód	cena Kč	cena EUR	balení [ks]		sk
						MB	VB	
75	6		36 125 075	403,00	16,792			H
90	6		36 125 090	490,00	20,417			H
110	6		36 125 110	677,00	28,208			H

### 36 126



#### tělo šroubení SDR11 na tupo

d mm	PN bar	m kg	objednáací kód	cena Kč	cena EUR	balení [ks]		sk
						MB	VB	
20	10		36 126 020	168,00	7,000			H
25	10		36 126 025	211,00	8,792			H
32	10		36 126 032	211,00	8,792			H
40	10		36 126 040	310,00	12,917			H
50	10		36 126 050	310,00	12,917			H
63	10		36 126 063	362,00	15,083			H
75	10		36 126 075	709,00	29,542			H
90	10		36 126 090	950,00	39,583			H
110	10		36 126 110	1 265,00	52,708			H

## PP-H tvarovky na tupo

36 127



tělo šroubení SDR17,6 na tupo

d mm	PN bar	m kg	objednáací kód	cena Kč	cena EUR	balení [ks]		sk
						MB	VB	
75	6		36 127 075	723,00	30,125			H
90	6		36 127 090	966,00	40,250			H
110	6		36 127 110	1 287,00	53,625			H

36 150



lemový nákrůžek SDR11 na tupo dlouhý

d mm	PN bar	m kg	objednáací kód	cena Kč	cena EUR	balení [ks]		sk
						MB	VB	
32	10		36 150 032 11	---	---			-
40	10		36 150 040 11	---	---			-
50	10		36 150 050 11	---	---			-
63	10		36 150 063 11	---	---			-
75	10		36 150 075 11	---	---			-
90	10		36 150 090 11	---	---			-
110	10		36 150 110 11	645,20	26,883			D
125	10		36 150 125 11	---	---			-
140	10		36 150 140 11	---	---			-
160	10		36 150 160 11	---	---			-
180	10		36 150 180 11	---	---			-
200	10		36 150 200 11	---	---			-
225	10		36 150 225 11	2 208,10	92,004			D
250	10		36 150 250 11	---	---			-
280	10		36 150 280 11	---	---			-
315	10		36 150 315 11	---	---			-

36 151



lemový nákrůžek SDR11 na tupo

d mm	PN bar	m kg	objednáací kód	cena Kč	cena EUR	balení [ks]		sk
						MB	VB	
20	10		36 151 020 11	78,00	3,250			H
25	10		36 151 025 11	87,00	3,625			H
32	10		36 151 032 11	112,00	4,667			H
40	10		36 151 040 11	132,00	5,500			H
50	10		36 151 050 11	164,00	6,833			H
63	10		36 151 063 11	181,00	7,542			H
75	10		36 151 075 11	203,00	8,458			H
90	10		36 151 090 11	321,00	13,375			H
110	10		36 151 110 11	362,00	15,083			H
125	10		36 151 125 11	480,00	20,000			H
140	10		36 151 140 11	532,00	22,167			H
160	10		36 151 160 11	661,00	27,542			H
180	10		36 151 180 11	1 046,00	43,583			H
200	10		36 151 200 11	1 083,00	45,125			H
225	10		36 151 225 11	1 268,00	52,833			H
250	10		36 151 250 11	1 994,00	83,083			H
280	10		36 151 280 11	2 111,00	87,958			H
315	10		36 151 315 11	2 569,00	107,042			H
355	10		36 151 355 11	4 508,00	187,833			H
400	10		36 151 400 11	9 340,00	389,167			H

## PP-H tvarovky na tupo

36 151



### lemový nákrůžek SDR17,6 na tupo

d mm	PN bar	m kg	objednací kód	cena Kč	cena EUR	balení [ks]		sk
						MB	VB	
50	6		36 151 050 17	132,00	5,500			H
63	6		36 151 063 17	163,00	6,792			H
75	6		36 151 075 17	385,00	16,042			H
90	6		36 151 090 17	262,00	10,917			H
110	6		36 151 110 17	332,00	13,833			H
125	6		36 151 125 17	450,00	18,750			H
140	6		36 151 140 17	499,00	20,792			H
160	6		36 151 160 17	611,00	25,458			H
180	6		36 151 180 17	999,00	41,625			H
200	6		36 151 200 17	1 076,00	44,833			H
225	6		36 151 225 17	1 224,00	51,000			H
250	6		36 151 250 17	1 853,00	77,208			H
280	6		36 151 280 17	1 977,00	82,375			H
315	6		36 151 315 17	2 433,00	101,375			H
355	6		36 151 355 17	4 277,00	178,208			H
400	6		36 151 400 17	9 020,00	375,833			H

40 160



### PP-V otočná příruba na tupo

PP plněný skelným vláknem (30%), tlaková třída PN16, rozteč šroubů PN10/PN16

d/DN mm	PN bar	m kg	objednací kód	cena Kč	cena EUR	balení [ks]		sk
						MB	VB	
d20/DN15	16		40 160 020	202,40	8,43			D
d25/DN20	16		40 160 025	227,90	9,50			D
d32/DN25	16		40 160 032	291,80	12,16			D
d40/DN32	16		40 160 040	343,80	14,33			D
d50/DN40	16		40 160 050	408,60	17,03			D
d63/DN50	16		40 160 063	512,80	21,37			D
d75/DN65	16		40 160 075	573,70	23,90			D
d90/DN80	16		40 160 090	683,70	28,49			D
d110/DN100	16		40 160 110	841,90	35,08			D

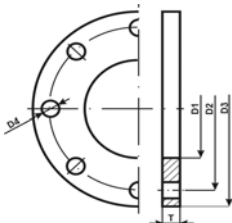

d/DN mm	D1 mm	D2 mm	D3 mm	počet děr	D4 mm	T mm
d20/DN15	28	65	95	4	14	16
d25/DN20	34	75	105	4	14	17
d32/DN25	42	85	115	4	14	18
d40/DN32	51	100	140	4	18	20
d50/DN40	62	110	150	4	18	22
d63/DN50	78	125	165	4	18	24
d75/DN65	92	145	185	4	18	26
d90/DN80	110	160	200	8	18	27
d110/DN100	133	180	220	8	18	28

## PP-H tvarovky na tupo

40 161



### PP-V otočná příruba s ocelovou vložkou, na tupo

tlaková třída PN16, rozteč šroubů do DN150 PN10/PN16, od DN200 PN10

d/DN mm	PN bar	m kg	objednací kód	cena Kč	cena EUR	balení [ks]		sk
						MB	VB	
d20/DN15	16		40 161 020	226,00	9,42			D
d25/DN20	16		40 161 025	273,00	11,38			D
d32/DN25	16		40 161 032	344,00	14,33			D
d40/DN32	16		40 161 040	385,00	16,04			D
d50/DN40	16		40 161 050C	462,00	18,48			C
d63/DN50	16		40 161 063C	486,20	19,45			C
d75/DN65	16		40 161 075C	547,10	21,88			C
d90/DN80	16		40 161 090C	737,80	29,51			A
d110/DN100	16		40 161 110C	786,30	31,45			A
d125/DN100	16		40 161 125C	795,80	31,83			A
d140/DN125	16		40 161 140C	963,30	38,53			A
d160/DN150	16		40 161 160C	1 482,90	59,32			A
d180/DN150	16		40 161 180	1 564,00	65,17			D
d200/DN200	16		40 161 200 10C	1 861,30	74,45			A
d225/DN200	16		40 161 225 10C	1 861,30	74,45			A
d250/DN250	16		40 161 250 10C	2 601,10	104,04			A
d280/DN250	16		40 161 280 10C	2 659,30	106,37			A
d315/DN300	16		40 161 315 10C	3 678,30	147,13			A
d355/DN350	16		40 161 355 10	8 316,00	346,50			D
d400/DN400	16		40 161 400 10	9 463,00	394,29			D

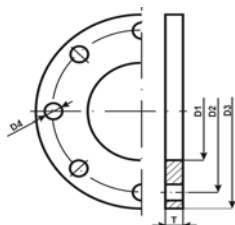

d/DN mm	D1 mm	D2 mm	D3 mm	počet děr	D4 mm	T mm
d20/DN15	28	65	95	4	14	12
d25/DN20	34	75	105	4	14	12
d32/DN25	42	85	115	4	14	16
d40/DN32	51	100	140	4	18	16
d50/DN40	62	110	150	4	18	20
d63/DN50	78	125	165	4	18	20
d75/DN65	92	145	185	4	18	20
d90/DN80	108	160	200	8	18	20
d110/DN100	128	180	220	8	18	20
d125/DN100	135	180	220	8	18	20
d140/DN125	158	210	250	8	18	24
d160/DN150	178	240	285	8	22	24
d180/DN150	188	240	285	8	22	24
d200/DN200	235	295	340	8	22	27
d225/DN200	238	295	340	8	22	27
d250/DN250	288	350	395	12	22	30
d280/DN250	294	350	395	12	22	30
d315/DN300	338	400	445	12	22	34
d355/DN350	376	460	515	16	22	40
d400/DN400	430	515	574	16	26	40

35 002

EPDM profilované gumokovové těsnění



d/DN mm	PN bar	m kg	objednací kód	cena Kč	cena EUR	balení [ks]		sk
						MB	VB	
d32/DN25 PN10-16	16		35 002 032	238,00	9,917			C
d40/DN32 PN10-16	16		35 002 040	245,00	10,208			C
d50/DN40 PN10-16	16		35 002 050	246,00	10,250			C
d63/DN50 PN10-16	16		35 002 063	266,00	11,083			C
d75/DN65 PN10-16	16		35 002 075	285,00	11,875			C
d90/DN80 PN10-16	16		35 002 090	298,00	12,417			C
d110/DN100 PN10-16	16		35 002 110	314,00	13,083			C
d125/DN100 PN10-16	16		35 002 125 100	420,00	17,500			C
d140/DN125 PN10-16	16		35 002 140	348,00	14,500			C
d160-d180/DN150 PN10-16	16		35 002 160	432,00	18,000			C
d200-d225/DN200 PN10-16	16		35 002 200	597,00	24,875			C
d250-d280/DN250 PN10-16	16		35 002 250	757,00	31,542			C
d315/DN300 PN10	10		35 002 315 10	848,00	35,333			C
d355/DN350 PN10	10		35 002 355 10	968,00	40,333			C
d400/DN400 PN10	10		35 002 400 10	1 177,00	49,042			C
d450-d500/DN500 PN10	10		35 002 450 10	---	---			-
d560-d630/DN600 PN10	10		35 002 560 10	---	---			-

35 003

FPM gumokovové těsnění pro přírubové spoje



d/DN mm	PN bar	m kg	objednací kód	cena Kč	cena EUR	balení [ks]		sk
						MB	VB	
d20/DN15 PN10-16	16		35 003 020	0,00	0,000			E
d25/DN20 PN10-16	16		35 003 025	0,00	0,000			E
d32/DN25 PN10-16	16		35 003 032	1 051,00	43,792			E
d40/DN32 PN10-16	16		35 003 040	1 088,00	45,333			E
d50/DN40 PN10-16	16		35 003 050	1 126,00	46,917			E
d63/DN50 PN10-16	16		35 003 063	1 198,00	49,917			E
d75/DN65 PN10-16	16		35 003 075	1 272,00	53,000			E
d90/DN80 PN10-16	16		35 003 090	1 361,00	56,708			E
d110/DN100 PN10-16	16		35 003 110	1 393,00	58,042			E
d125/DN100 PN10-16	16		35 003 125 100	0,00	0,000			E
d140/DN125 PN10-16	16		35 003 140	1 470,00	61,250			E
d160-d180/DN150 PN10-16	16		35 003 160	1 796,00	74,833			E



**kulový kohout 546, EPDM, polyfuzní**



d16-d63



d75-d110

d mm	PN bar	m kg	objednáací kód	cena Kč	cena EUR		$k_v$ l/min	sk
16	10	0,115	167 546 401	1 379,00	57,458		71	H
20	10	0,115	167 546 402	1 428,00	59,500		185	H
25	10	0,180	167 546 403	1 699,00	70,792		350	H
32	10	0,255	167 546 404	2 084,00	86,833		700	H
40	10	0,440	167 546 405	2 608,00	108,667		1 000	H
50	10	0,610	167 546 406	3 396,00	141,500		1 600	H
63	10	1,145	167 546 407	4 197,00	174,875		3 100	H
75	10	3,700	167 546 408	9 707,00	404,458		5 000	H
90	10	5,500	167 546 409	12 082,00	503,417		7 000	H
110	10	8,700	167 546 410	14 512,00	604,667		11 000	H

$k_v$  pro  $\Delta p = 1\text{bar}$

**kulový kohout 546, FPM, polyfuzní**

d mm	PN bar	m kg	objednáací kód	cena Kč	cena EUR		$k_v$ l/min	sk
16	10	0,115	167 546 411	1 679,00	69,958		71	H
20	10	0,115	167 546 412	1 728,00	72,000		185	H
25	10	0,180	167 546 413	2 024,00	84,333		350	H
32	10	0,255	167 546 414	2 548,00	106,167		700	H
40	10	0,440	167 546 415	3 148,00	131,167		1 000	H
50	10	0,610	167 546 416	4 197,00	174,875		1 600	H
63	10	1,145	167 546 417	5 330,00	222,083		3 100	H
75	10	3,700	167 546 418	11 906,00	496,083		5 000	H
90	10	5,500	167 546 419	14 816,00	617,333		7 000	H
110	10	8,700	167 546 420	17 778,00	740,750		11 000	H

$k_v$  pro  $\Delta p = 1\text{bar}$

**kulový kohout 546, EPDM, vnitřní závity Rp se zpevňujícím kroužkem**

matice pro ukotvení



Rp inch	PN bar	m kg	objednáací kód	cena Kč	cena EUR		$k_v$ l/min	sk
3/8"	10	0,120	167 546 021	1 871,00	77,958		71	H
1/2"	10	0,120	167 546 022	1 940,00	80,833		185	H
3/4"	10	0,180	167 546 023	2 261,00	94,208		350	H
1"	10	0,270	167 546 024	2 773,00	115,542		700	H
5/4"	10	0,160	167 546 025	3 455,00	143,958		1 000	H
6/4"	10	0,635	167 546 026	4 363,00	181,792		1 600	H
2"	10	0,190	167 546 027	5 291,00	220,458		3 100	H

$k_v$  pro  $\Delta p = 1\text{bar}$

**kulový kohout 546, FPM, vnitřní závity Rp se zpevňujícím kroužkem**

matice pro ukotvení



Rp inch	PN bar	m kg	objednáací kód	cena Kč	cena EUR		$k_v$ l/min	sk
3/8"	10	0,120	167 546 031	2 264,00	94,333		71	H
1/2"	10	0,120	167 546 032	2 258,00	94,083		185	H
3/4"	10	0,180	167 546 033	2 586,00	107,750		350	H
1"	10	0,270	167 546 034	3 376,00	140,667		700	H
5/4"	10	0,160	167 546 035	4 168,00	173,667		1 000	H
6/4"	10	0,635	167 546 036	5 382,00	224,250		1 600	H
2"	10	0,190	167 546 037	6 424,00	267,667		3 100	H

$k_v$  pro  $\Delta p = 1\text{bar}$



d16-d63



d75-d110

**kulový kohout 546, EPDM, SDR11 na tupo, matice pro ukotvení**

d mm	PN bar	m kg	objednáací kód	cena Kč	cena EUR		k <sub>v</sub> l/min	sk
20	10		167 546 442	1 508,00	62,833		185	H
25	10		167 546 443	1 798,00	74,917		350	H
32	10		167 546 444	2 221,00	92,542		700	H
40	10		167 546 445	2 745,00	114,375		1 000	H
50	10		167 546 446	3 564,00	148,500		1 600	H
63	10		167 546 447	4 335,00	180,625		3 100	H
75	10		167 546 448	9 707,00	404,458		5 000	H
90	10		167 546 449	12 082,00	503,417		7 000	H
110	10		167 546 450	14 512,00	604,667		11 000	H

**kulový kohout 546, FPM, SDR11 na tupo, matice pro ukotvení**

d mm	PN bar	m kg	objednáací kód	cena Kč	cena EUR		k <sub>v</sub> l/min	sk
20	10		167 546 452	1 823,00	75,958		185	H
25	10		167 546 453	2 124,00	88,500		350	H
32	10		167 546 454	2 686,00	111,917		700	H
40	10		167 546 455	3 288,00	137,000		1 000	H
50	10		167 546 456	4 363,00	181,792		1 600	H
63	10		167 546 457	5 469,00	227,875		3 100	H
75	10		167 546 458	12 264,00	511,000		5 000	H
90	10		167 546 459	14 816,00	617,333		7 000	H
110	10		167 546 460	17 778,00	740,750		11 000	H

**kulový kohout 546, EPDM, SDR17 na tupo, matice pro ukotvení**

d mm	PN bar	m kg	objednáací kód	cena Kč	cena EUR		k <sub>v</sub> l/min	sk
50	10		167 546 066	3 564,00	148,500		1 600	H
63	10		167 546 067	4 335,00	180,625		3 100	H
75	10		167 546 068	9 545,00	397,708		5 000	H
90	10		167 546 069	11 924,00	496,833		7 000	H
110	10		167 546 070	14 264,00	594,333		11 000	H

**kulový kohout 546, FPM, SDR17 na tupo, matice pro ukotvení**

d mm	PN bar	m kg	objednáací kód	cena Kč	cena EUR		k <sub>v</sub> l/min	sk
50	10		167 546 076	4 550,00	189,583		1 600	H
63	10		167 546 077	5 469,00	227,875		3 100	H
75	10		167 546 078	12 249,00	510,375		5 000	H
90	10		167 546 079	14 657,00	610,708		7 000	H
110	10		167 546 080	18 280,00	761,667		11 000	H



**kulový kohout třicečný 543, EPDM, vrtání L, polyfuzní**

d mm	PN bar	m kg	objednáací kód	cena Kč	cena EUR		k <sub>v</sub> l/min	sk
16	10	0,161	167 543 001	2 947,00	122,792		50	H
20	10	0,165	167 543 002	3 020,00	125,833		75	H
25	10	0,237	167 543 003	3 439,00	143,292		150	H
32	10	0,361	167 543 004	4 382,00	182,583		280	H
40	10	0,616	167 543 005	4 909,00	204,542		480	H
50	10	0,912	167 543 006	5 779,00	240,792		620	H
63	10	1,773	167 543 007	6 955,00	289,792		1 230	H

k<sub>v</sub> pro Δp = 1bar



**kulový kohout třicečný 543, FPM, vrtání L, polyfuzní**

d mm	PN bar	m kg	objednáací kód	cena Kč	cena EUR		k <sub>v</sub> l/min	sk
16	10	0,161	167 543 011	3 733,00	155,542		50	H
20	10	0,165	167 543 012	3 679,00	153,292		75	H
25	10	0,237	167 543 013	4 208,00	175,333		150	H
32	10	0,361	167 543 014	5 404,00	225,167		280	H
40	10	0,616	167 543 015	5 945,00	247,708		480	H
50	10	0,912	167 543 016	7 181,00	299,208		620	H
63	10	1,773	167 543 017	9 031,00	376,292		1 230	H

k<sub>v</sub> pro Δp = 1bar



**kulový kohout třicečný 543, EPDM, vrtání T, polyfuzní**

d mm	PN bar	m kg	objednáací kód	cena Kč	cena EUR		k <sub>v</sub> l/min	sk
16	10	0,160	167 543 201	2 947,00	122,792		140	H
20	10	0,164	167 543 202	3 020,00	125,833		200	H
25	10	0,236	167 543 203	3 439,00	143,292		470	H
32	10	0,357	167 543 204	4 382,00	182,583		793	H
40	10	0,609	167 543 205	4 909,00	204,542		1 290	H
50	10	0,898	167 543 206	5 779,00	240,792		1 910	H
63	10	1,744	167 543 207	6 955,00	289,792		3 100	H

k<sub>v</sub> pro Δp = 1bar



**kulový kohout třicečný 543, FPM, vrtání T, polyfuzní**

d mm	PN bar	m kg	objednáací kód	cena Kč	cena EUR		k <sub>v</sub> l/min	sk
16	10	0,160	167 543 211	3 581,00	149,208		140	H
20	10	0,164	167 543 212	3 679,00	153,292		200	H
25	10	0,236	167 543 213	4 208,00	175,333		470	H
32	10	0,357	167 543 214	5 404,00	225,167		793	H
40	10	0,609	167 543 215	5 945,00	247,708		1 290	H
50	10	0,898	167 543 216	7 488,00	312,000		1 910	H
63	10	1,744	167 543 217	9 031,00	376,292		3 100	H

k<sub>v</sub> pro Δp = 1bar



**uzavírací klapka 567, EPDM, s pákou**

d/DN mm	PN bar	m kg	objednáací kód	cena Kč	cena EUR		k <sub>v</sub> l/min	sk
d63/DN50	10		167 567 002	7 209,00	300,375			H
d75/DN65	10		167 567 003	7 689,00	320,375			H
d90/DN80	10		167 567 004	8 704,00	362,667			H
d110/DN100	10		167 567 005	10 466,00	436,083			H
d140/DN125	10		167 567 006	13 613,00	567,208			H
d160/DN150	10		167 567 007	15 001,00	625,042			H
d225/DN200	10		167 567 008	19 272,00	803,000			H
d280/DN250	8		167 567 009	56 447,00	2 351,958			H
d315/DN300	8		167 567 010	71 429,00	2 976,208			H



**uzavírací klapka 567, FPM, s pákou**

d/DN mm	PN bar	m kg	objednáací kód	cena Kč	cena EUR		k <sub>v</sub> l/min	sk
d63/DN50	10		167 567 022	9 344,00	389,333			H
d75/DN65	10		167 567 023	10 090,00	420,417			H
d90/DN80	10		167 567 024	11 104,00	462,667			H
d110/DN100	10		167 567 025	13 452,00	560,500			H
d140/DN125	10		167 567 026	17 244,00	718,500			H
d160/DN150	10		167 567 027	20 712,00	863,000			H
d225/DN200	10		167 567 028	24 182,00	1 007,583			H
d280/DN250	8		167 567 029	66 957,00	2 789,875			H
d315/DN300	8		167 567 030	88 518,00	3 688,250			H



**uzavírací klapka 567, EPDM, s převodovkou**

d/DN mm	PN bar	m kg	objednáací kód	cena Kč	cena EUR		k <sub>v</sub> l/min	sk
d63/DN50	10		167 567 042	12 249,00	510,375			H
d75/DN65	10		167 567 043	12 497,00	520,708			H
d90/DN80	10		167 567 044	13 302,00	554,250			H
d110/DN100	10		167 567 045	14 824,00	617,667			H
d140/DN125	10		167 567 046	18 211,00	758,792			H
d160/DN150	10		167 567 047	18 652,00	777,167			H
d225/DN200	10		167 567 048	22 265,00	927,708			H
d280/DN250	8		167 567 049	56 776,00	2 365,667			H
d315/DN300	8		167 567 050	70 141,00	2 922,542			H



**uzavírací klapka 567, FPM, s převodovkou**

d/DN mm	PN bar	m kg	objednáací kód	cena Kč	cena EUR		k <sub>v</sub> l/min	sk
d63/DN50	10		167 567 062	14 470,00	602,917			H
d75/DN65	10		167 567 063	14 469,00	602,875			H
d90/DN80	10		167 567 064	15 360,00	640,000			H
d110/DN100	10		167 567 065	17 313,00	721,375			H
d140/DN125	10		167 567 066	20 525,00	855,208			H
d160/DN150	10		167 567 067	24 496,00	1 020,667			H
d225/DN200	10		167 567 068	26 415,00	1 100,625			H
d280/DN250	8		167 567 069	68 982,00	2 874,250			H
d315/DN300	8		167 567 070	85 677,00	3 569,875			H



**membránový ventil 514, EPDM, polyfuzní**

d mm	PN bar	m kg	objednáací kód	cena Kč	cena EUR		k <sub>v</sub> l/min	sk
20	10	0,267	167 514 012	2 489,00	103,708		125	H
25	10	0,391	167 514 013	2 690,00	112,083		271	H
32	10	1,080	167 514 014	3 286,00	136,917		481	H
40	10	1,277	167 514 015	3 932,00	163,833		759	H
50	10	1,386	167 514 016	5 126,00	213,583		1 263	H
63	10	3,030	167 514 017	6 408,00	267,000		1 728	H

k<sub>v</sub> pro Δp = 1bar



**membránový ventil 514, PTFE s EPDM podkladem, polyfuzní**

d mm	PN bar	m kg	objednáací kód	cena Kč	cena EUR		k <sub>v</sub> l/min	sk
20	10	0,267	167 514 032	5 126,00	213,583		125	H
25	10	0,391	167 514 033	5 195,00	216,458		271	H
32	10	1,080	167 514 034	6 002,00	250,083		481	H
40	10	1,277	167 514 035	7 677,00	319,875		759	H
50	10	1,386	167 514 036	9 754,00	406,417		1 263	H
63	10	3,030	167 514 037	12 121,00	505,042		1 728	H

k<sub>v</sub> pro Δp = 1bar



**membránový ventil 514, FPM, polyfuzní**

d mm	PN bar	m kg	objednáací kód	cena Kč	cena EUR		k <sub>v</sub> l/min	sk
20	10	0,267	167 514 062	5 126,00	213,583		125	H
25	10	0,391	167 514 063	5 195,00	216,458		271	H
32	10	1,080	167 514 064	6 002,00	250,083		481	H
40	10	1,277	167 514 065	7 677,00	319,875		759	H
50	10	1,386	167 514 066	9 754,00	406,417		1 263	H
63	10	3,030	167 514 067	12 121,00	505,042		1 728	H

k<sub>v</sub> pro Δp = 1bar

**membránový ventil pneumatický DIASTAR, FC, EPDM**

polyfuzní



d mm	PN bar	m kg	objednáací kód	cena Kč	cena EUR		$k_v$ l/min	sk
20	10	0,526	167 624 012	8 365,00	348,542		125	H
25	10	1,071	167 624 013	8 936,00	372,333		271	H
32	10	1,286	167 624 014	9 453,00	393,875		481	H
40	10	2,152	167 624 015	11 859,00	494,125		759	H
50	10	3,623	167 624 016	14 342,00	597,583		1 263	H
63	10	5,032	167 624 017	18 100,00	754,167		1 728	H

$k_v$  pro  $\Delta p = 1\text{bar}$

**membránový ventil pneumatický DIASTAR, FC, PTFE/EPDM**

polyfuzní



d mm	PN bar	m kg	objednáací kód	cena Kč	cena EUR		$k_v$ l/min	sk
20	10	0,526	167 624 032	10 770,00	448,750		125	H
25	10	1,071	167 624 033	11 572,00	482,167		271	H
32	10	1,286	167 624 034	12 374,00	515,583		481	H
40	10	2,152	167 624 035	15 410,00	642,083		759	H
50	10	3,623	167 624 036	18 446,00	768,583		1 263	H
63	6	5,032	167 624 037	23 768,00	990,333		1 728	H

$k_v$  pro  $\Delta p = 1\text{bar}$

**membránový ventil pneumatický DIASTAR, FC, FPM**

polyfuzní



d mm	PN bar	m kg	objednáací kód	cena Kč	cena EUR		$k_v$ l/min	sk
20	10	0,526	167 624 062	8 531,00	355,458		125	H
25	10	1,071	167 624 063	8 659,00	360,792		271	H
32	10	1,286	167 624 064	9 472,00	394,667		481	H
40	10	2,152	167 624 065	12 248,00	510,333		759	H
50	10	3,623	167 624 066	15 310,00	637,917		1 263	H
63	10	5,032	167 624 067	20 912,00	871,333		1 728	H

$k_v$  pro  $\Delta p = 1\text{bar}$

**membránový ventil pneumatický DIASTAR, FO, EPDM**

polyfuzní



d mm	PN bar	m kg	objednáací kód	cena Kč	cena EUR		$k_v$ l/min	sk
20	10	0,515	167 644 012	5 787,00	241,125		125	H
25	10	0,919	167 644 013	6 245,00	260,208		271	H
32	10	1,079	167 644 014	6 530,00	272,083		481	H
40	10	1,726	167 644 015	8 249,00	343,708		759	H
50	10	3,533	167 644 016	10 368,00	432,000		1 263	H
63	10	4,266	167 644 017	12 546,00	522,750		1 728	H

$k_v$  pro  $\Delta p = 1\text{bar}$

**membránový ventil pneumatický DIASTAR, FO, PTFE/EPDM**

polyfuzní



d mm	PN bar	m kg	objednáací kód	cena Kč	cena EUR		$k_v$ l/min	sk
20	10	0,515	167 644 032	8 266,00	344,417		125	H
25	10	0,919	167 644 033	8 810,00	367,083		271	H
32	10	1,079	167 644 034	9 022,00	375,917		481	H
40	10	1,726	167 644 035	11 170,00	465,417		759	H
50	10	3,533	167 644 036	14 782,00	615,917		1 263	H
63	10	4,266	167 644 037	17 918,00	746,583		1 728	H

$k_v$  pro  $\Delta p = 1\text{bar}$

**membránový ventil pneumatický DIASTAR, DA, EPDM**

polyfuzní



d mm	PN bar	m kg	objednáací kód	cena Kč	cena EUR		k <sub>v</sub> l/min	sk
20	10	0,499	167 654 012	6 094,00	253,917		125	H
25	10	0,883	167 654 013	6 577,00	274,042		271	H
32	10	1,077	167 654 014	6 879,00	286,625		481	H
40	10	1,666	167 654 015	8 688,00	362,000		759	H
50	10	2,783	167 654 016	10 921,00	455,042		1 263	H
63	10	3,516	167 654 017	13 214,00	550,583		1 728	H

k<sub>v</sub> pro Δp = 1bar

**membránový ventil pneumatický DIASTAR, DA, PTFE/EPDM**

polyfuzní



d mm	PN bar	m kg	objednáací kód	cena Kč	cena EUR		k <sub>v</sub> l/min	sk
20	10	0,499	167 654 032	8 266,00	344,417		125	H
25	10	0,883	167 654 033	8 365,00	348,542		271	H
32	10	1,077	167 654 034	8 936,00	372,333		481	H
40	10	1,666	167 654 035	11 170,00	465,417		759	H
50	10	2,783	167 654 036	14 035,00	584,792		1 263	H
63	10	3,516	167 654 037	17 013,00	708,875		1 728	H

k<sub>v</sub> pro Δp = 1bar

**zpětný ventil 561, EPDM, polyfuzní**



d mm	PN bar	m kg	objednáací kód	cena Kč	cena EUR		k <sub>v</sub> l/min	sk
16	10	0,080	167 561 001	1 808,00	75,333		190	H
20	10	0,080	167 561 002	1 808,00	75,333		180	H
25	10	0,180	167 561 003	1 917,00	79,875		380	H
32	10	0,190	167 561 004	2 126,00	88,583		460	H
40	10	0,340	167 561 005	2 527,00	105,292		850	H
50	10	0,480	167 561 006	2 864,00	119,333		1 080	H
63	10	0,974	167 561 007	4 202,00	175,083		1 670	H
75	10	2,310	167 561 008	8 398,00	349,917		2 950	H
90	10	3,580	167 561 009	10 498,00	437,417		3 600	H
110	10	5,930	167 561 010	12 599,00	524,958		4 150	H

k<sub>v</sub> pro Δp = 1bar

**zpětný ventil 561, FPM, polyfuzní**



d mm	PN bar	m kg	objednáací kód	cena Kč	cena EUR		k <sub>v</sub> l/min	sk
16	10	0,080	167 561 011	2 169,00	90,375		190	H
20	10	0,080	167 561 012	2 169,00	90,375		180	H
25	10	0,180	167 561 013	2 301,00	95,875		380	H
32	10	0,190	167 561 014	2 550,00	106,250		460	H
40	10	0,340	167 561 015	3 033,00	126,375		850	H
50	10	0,480	167 561 016	3 436,00	143,167		1 080	H
63	10	0,974	167 561 017	5 041,00	210,042		1 670	H
75	10	2,310	167 561 018	10 077,00	419,875		2 950	H
90	10	3,580	167 561 019	12 599,00	524,958		3 600	H
110	10	5,930	167 561 020	15 117,00	629,875		4 150	H

k<sub>v</sub> pro Δp = 1bar



**zpětný ventil 562, EPDM, s nerezovou pružinou 1.4310, polyfuzní**

d mm	PN bar	m kg	objednáací kód	cena Kč	cena EUR		$k_v$ l/min	sk
16	10	0,080	167 562 001	2 084,00	86,833		190	H
20	10	0,080	167 562 002	2 084,00	86,833		180	H
25	10	0,180	167 562 003	2 235,00	93,125		380	H
32	10	0,190	167 562 004	2 466,00	102,750		460	H
40	10	0,340	167 562 005	2 938,00	122,417		850	H
50	10	0,480	167 562 006	3 373,00	140,542		1 080	H
63	10	0,974	167 562 007	4 922,00	205,083		1 670	H
75	10	2,310	167 562 008	9 840,00	410,000		2 950	H
90	10	3,580	167 562 009	12 301,00	512,542		3 600	H
110	10	5,930	167 562 010	15 391,00	641,292		4 150	H

$k_v$  pro  $\Delta p = 1\text{bar}$



**zpětný ventil 562, FPM, s nerezovou pružinou 1.4310, polyfuzní**

d mm	PN bar	m kg	objednáací kód	cena Kč	cena EUR		$k_v$ l/min	sk
16	10	0,080	167 562 011	2 549,00	106,208		190	H
20	10	0,080	167 562 012	2 445,00	101,875		180	H
25	10	0,180	167 562 013	2 618,00	109,083		380	H
32	10	0,190	167 562 014	2 890,00	120,417		460	H
40	10	0,340	167 562 015	3 444,00	143,500		850	H
50	10	0,480	167 562 016	3 945,00	164,375		1 080	H
63	10	0,974	167 562 017	5 762,00	240,083		1 670	H
75	10	2,310	167 562 018	12 012,00	500,500		2 950	H
90	10	3,580	167 562 019	15 014,00	625,583		3 600	H
110	10	5,930	167 562 020	18 018,00	750,750		4 150	H

$k_v$  pro  $\Delta p = 1\text{bar}$



## PE

Polyetylen je nejznámějším užívaným plastem, jehož stavební prvky tvoří pouze vodík a uhlík. Jedná se vlastně o částečně krystalizovaný termoplast s vynikajícími mechanickými vlastnostmi, výbornou chemickou odolností, vysokou houževnatostí a odolností proti UV záření. Jako jeden z mála odolává povětrnostním vlivům a dosahuje tak dlouhé životnosti. Široký teplotní rozsah umožňuje jeho časté použití. Polyetylen je nejrozšířenější materiál pro realizaci zemních rozvodů vody a plynu. S výhodou je však využíván i pro domácí technologie a průmyslové rozvody plyných a kapalných médií. PE je podobně jako PP-H nepolární materiál. Polyetylen je těžko zápalný a ve většině rozpouštědel nerozpustný materiál. Spojování se provádí svařováním buď pomocí elektrotvarovek, nebo na tupo.

Ve výstavbě průmyslových potrubních rozvodů se nejvíce používá vysokomolekulární typ vysoké hustoty označovaný jako PE100. Mezi výhody dále patří nízká hmotnost a snadná manipulace, která nabývá na významu hlavně u montáže potrubí velkých dimenzí.

Každá elektrotvarovka je označena štítkem s čárovým kódem a tabulkou pro manuální zadání dat, včetně údaje o době chladnutí. Dále obsahuje údaje o výrobku – typ granulátu, výrobní dávka, atp. (tzv. zpětná sledovatelnost).

Svařitelnost je zaručena s trubkami z PE80 a PE100 za předpokladu, že index toku taveniny materiálu trubek je v rozmezí 0,2 až 1,4 g/10min.

### Základní informace

- trubky v dimenzích od d16 mm do d1200 mm
- tvarovky v dimenzích od d20 mm do d1200 mm
- provozní tlaky PN6, PN10, PN16, PN20 a PN25
- teplotní rozsah: od -40°C do +100°C, pro použití v tlakových potrubních systémech od -20°C do +60°C
- spojování svařováním elektrotvarovkami, na tupo nebo polyfúzně

### Hlavní charakteristika a výhody

- nízká hmotnost a snadná manipulace
- dobrá chemická odolnost - široké použití na velký počet druhů kyselin a louhů. Podmíněně je odolný pro nasazení na uhlovodíky, chlor a ozon.
- odolnost proti korozi
- rázová houževnatost i při nízkých teplotách
- odolnost proti stárnutí vlivem povětrnostních vlivů a UV záření
- svařitelnost
- fyziologická nezávadnost
- ekonomické výhody vyplývající z materiálu i snadné manipulace a rychlosti montáže

### Kde se polyetylen používá

- vodovody a kanalizace
- plynovody
- bazénové technologie
- chemický průmysl
- energetika
- strojírenství
- čistírny odpadních vod

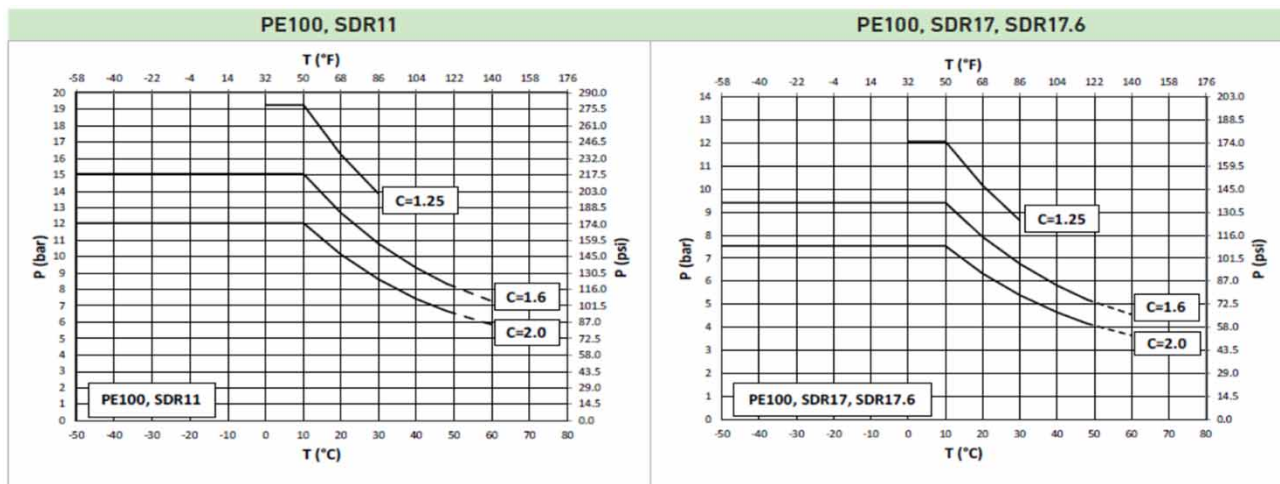

## PE tlakové trubky

40 506

**LDPE40 SDR11 PN6, barva černá**



d x e mm	PN bar	m kg/m	objednáací kód	cena Kč/m	cena EUR/m	návin m	sk
16 x 2	6	0,100	40 506 016 200	9,40	0,39	200	E
20 x 2	6	0,118	40 506 020 200	10,90	0,45	200	E
25 x 2,3	6	0,160	40 506 025 100	14,70	0,61	100	E
32 x 2,9	6	0,260	40 506 032 100	24,00	1,00	100	E
40 x 3,7	6	0,410	40 506 040 100	37,70	1,57	100	E
50 x 4,6	6	0,660	40 506 050 050	60,70	2,53	50	E
63 x 5,8	6	1,000	40 506 063 050	92,30	3,85	50	E

40 510

**HDPE100 SDR17 PN10 barva černá s modrým pruhem**



d x e mm	PN bar	m kg/m	objednáací kód	cena Kč/m	cena EUR/m	délky m	sk
50 x 3,0	10	0,450	40 510 050 006	47,10	1,96	6, 12, 100	E
63 x 3,8	10	0,710	40 510 063 006	79,50	3,31	6, 12, 100	E
75 x 4,5	10	1,010	40 510 075 006	110,90	4,62	6, 12, 100	E
90 x 5,4	10	1,450	40 510 090 006	153,00	6,38	6, 12, 100	E
110 x 6,6	10	2,150	40 510 110 006	233,70	9,74	6, 12, 100	E
125 x 7,4	10	2,740	40 510 125 006	301,50	12,56	6, 12	E
140 x 8,3	10	3,490	40 510 140 006	367,10	15,30	6, 12	E
160 x 9,5	10	4,560	40 510 160 006	485,60	20,23	6, 12	E
180 x 10,7	10	5,760	40 510 180 006	605,40	25,23	6, 12	E
200 x 11,9	10	7,110	40 510 200 006	747,90	31,16	6, 12	E
225 x 13,4	10	9,010	40 510 225 006	957,30	39,89	6, 12	E
250 x 14,8	10	11,000	40 510 250 006	1 157,00	48,21	6, 12	E
280 x 16,6	10	13,900	40 510 280 006	1 463,00	60,96	6, 12	E
315 x 18,7	10	17,600	40 510 315 006	1 852,00	77,17	6, 12	E
355 x 21,1	10	22,300	40 510 355 006	2 346,00	97,75	6, 12	E
400 x 23,7	10	28,200	40 510 400 006	2 967,00	123,63	6, 12	E

40 510 xxx 006 = tyč 6m

40 510 xxx 012 = tyč 12m

40 510 xxx 100 = návin 100m

40 516

**HDPE100 SDR11 PN16, barva černá s modrým pruhem**



d x e mm	PN bar	m kg/m	objednáací kód	cena Kč/m	cena EUR/m	délky m	sk
16 x 1,8	16	0,084	40 516 016 006	15,00	0,63	6	E
20 x 1,9	16	0,113	40 516 020 006	20,40	0,85	6	E
25 x 2,3	16	0,172	40 516 025 006	19,70	0,82	6, 12, 100	E
32 x 3,0	16	0,279	40 516 032 006	29,70	1,24	6, 12, 100	E
40 x 3,7	16	0,433	40 516 040 006	44,60	1,86	6, 12, 100	E
50 x 4,6	16	0,627	40 516 050 006	70,00	2,92	6, 12, 100	E
63 x 5,8	16	1,060	40 516 063 006	112,20	4,68	6, 12, 100	E
75 x 6,8	16	1,480	40 516 075 006	151,20	6,30	6, 12, 100	E
90 x 8,2	16	2,140	40 516 090 006	215,30	8,97	6, 12, 100	E
110 x 10,0	16	3,170	40 516 110 006	330,40	13,77	6, 12, 100	E
125 x 11,4	16	4,110	40 516 125 006	428,80	17,87	6, 12	E
140 x 12,7	16	5,120	40 516 140 006	538,60	22,44	6, 12	E
160 x 14,6	16	6,720	40 516 160 006	706,30	29,43	6, 12	E
180 x 16,4	16	8,490	40 516 180 006	893,00	37,21	6, 12	E
200 x 18,2	16	10,500	40 516 200 006	1 104,00	46,00	6, 12	E
225 x 20,5	16	13,300	40 516 225 006	1 396,00	58,17	6, 12	E
250 x 22,7	16	16,300	40 516 250 006	1 715,00	71,46	6, 12	E
280 x 25,4	16	20,400	40 516 280 006	2 147,00	89,46	6, 12	E
315 x 28,6	16	25,900	40 516 315 006	2 724,00	113,50	6, 12	E
355 x 32,2	16	32,800	40 516 355 006	3 450,00	143,75	6, 12	E
400 x 36,3	16	41,600	40 516 400 006	4 375,00	182,29	6, 12	E

40 516 xxx 006 = tyč 6m

40 516 xxx 012 = tyč 12m

40 516 xxx 100 = návin 100m

## 40 536

### HDPE100 RC TECH SDR17 PN10 PAS1075-2 dvouvrstvá

Potrubi RC TECH je vyrobeno z nového materiálu PE 100 RC, což je materiál mimořádně odolný vůči bodové zátěži a následnému šíření trhliny stěnou trubky. Trubky RC TECH odolávají zejména vlivům při pokládce do výkopu bez pískového lože a dlouhodobým bodovým zatížením. Jádro potrubí černé, venkovní vrstva modrá (10% tloušťky stěny).



d x e mm	PN bar	m kg/m	objednací kód	cena Kč/m	cena EUR/m	délky m	sk
50 x 3,0	10	0,450	40 536 050 006	60,50	2,52	6, 12, 100	E
63 x 3,8	10	0,710	40 536 063 006	90,70	3,78	6, 12, 100	E
75 x 4,5	10	1,010	40 536 075 006	124,40	5,18	6, 12, 100	E
90 x 5,4	10	1,450	40 536 090 006	177,10	7,38	6, 12, 100	E
110 x 6,6	10	2,150	40 536 110 006	246,20	10,26	6, 12, 100	E
125 x 7,4	10	2,740	40 536 125 006	315,40	13,14	6, 12	E
140 x 8,3	10	3,490	40 536 140 006	393,10	16,38	6, 12	E
160 x 9,5	10	4,560	40 536 160 006	513,20	21,38	6, 12	E
180 x 10,7	10	5,760	40 536 180 006	648,90	27,04	6, 12	E
200 x 11,9	10	7,110	40 536 200 006	805,20	33,55	6, 12	E
225 x 13,4	10	9,010	40 536 225 006	1 016,00	42,33	6, 12	E
250 x 14,8	10	11,000	40 536 250 006	1 261,00	52,54	6, 12	E
280 x 16,6	10	13,900	40 536 280 006	1 589,00	66,21	6, 12	E
315 x 18,7	10	17,600	40 536 315 006	2 009,00	83,71	6, 12	E
355 x 21,1	10	22,300	40 536 355 006	2 557,00	106,54	6, 12	E
400 x 23,7	10	28,200	40 536 400 006	3 258,00	135,75	6, 12	E

40 536 xxx 006 = tyč 6m

40 536 xxx 012 = tyč 12m

40 536 xxx 100 = návin 100m

## 40 537

### HDPE100 RC TECH SDR11 PN16 PAS1075-2 dvouvrstvá

Potrubi RC TECH je vyrobeno z nového materiálu PE 100 RC, což je materiál mimořádně odolný vůči bodové zátěži a následnému šíření trhliny stěnou trubky. Trubky RC TECH odolávají zejména vlivům při pokládce do výkopu bez pískového lože a dlouhodobým bodovým zatížením. Jádro potrubí černé, venkovní vrstva modrá (10% tloušťky stěny).



d x e mm	PN bar	m kg/m	objednací kód	cena Kč/m	cena EUR/m	délky m	sk
25 x 2,3	16	0,172	40 537 025 006	---	---	6, 12, 100	-
32 x 3,0	16	0,279	40 537 032 006	33,70	1,40	6, 12, 100	E
40 x 3,7	16	0,433	40 537 040 006	51,00	2,13	6, 12, 100	E
50 x 4,6	16	0,627	40 537 050 006	82,10	3,42	6, 12, 100	E
63 x 5,8	16	1,060	40 537 063 006	125,30	5,22	6, 12, 100	E
75 x 6,8	16	1,480	40 537 075 006	171,10	7,13	6, 12, 100	E
90 x 8,2	16	2,140	40 537 090 006	250,60	10,44	6, 12, 100	E
110 x 10,0	16	3,170	40 537 110 006	362,90	15,12	6, 12, 100	E
125 x 11,4	16	4,110	40 537 125 006	457,10	19,05	6, 12	E
140 x 12,7	16	5,120	40 537 140 006	578,90	24,12	6, 12	E
160 x 14,6	16	6,720	40 537 160 006	756,90	31,54	6, 12	E
180 x 16,4	16	8,490	40 537 180 006	952,10	39,67	6, 12	E
200 x 18,2	16	10,500	40 537 200 006	1 179,00	49,13	6, 12	E
225 x 20,5	16	13,300	40 537 225 006	1 489,00	62,04	6, 12	E
250 x 22,7	16	16,300	40 537 250 006	1 857,00	77,38	6, 12	E
280 x 25,4	16	20,400	40 537 280 006	2 329,00	97,04	6, 12	E
315 x 28,6	16	25,900	40 537 315 006	2 954,00	123,08	6, 12	E
355 x 32,2	16	32,800	40 537 355 006	4 033,00	168,04	6, 12	E
400 x 36,3	16	41,600	40 537 400 006	4 787,00	199,46	6, 12	E

40 537 xxx 006 = tyč 6m

40 537 xxx 012 = tyč 12m

40 537 xxx 100 = návin 100m

## PE Polyfuzní tvarovky

40 002



### PE80 koleno 90° polyfuzní

d mm	PN bar	m kg	objednáací kód	cena Kč	cena EUR	balení [ks]		sk
						MB	VB	
20	10		40 002 020	118,00	4,92			H
25	10		40 002 025	137,00	5,71			H
32	10		40 002 032	161,00	6,71			H
40	10		40 002 040	213,00	8,88			H
50	10		40 002 050	383,00	15,96			H
63	10		40 002 063	498,00	20,75			H

40 012



### PE80 koleno 45° polyfuzní

d mm	PN bar	m kg	objednáací kód	cena Kč	cena EUR	balení [ks]		sk
						MB	VB	
20	10		40 012 020	158,00	6,58			H
25	10		40 012 025	181,00	7,54			H
32	10		40 012 032	181,00	7,54			H
40	10		40 012 040	281,00	11,71			H
50	10		40 012 050	362,00	15,08			H
63	10		40 012 063	475,00	19,79			H

40 043



### PE80 T-kus polyfuzní

d mm	PN bar	m kg	objednáací kód	cena Kč	cena EUR	balení [ks]		sk
						MB	VB	
20	10		40 043 020	158,00	6,58			H
25	10		40 043 025	158,00	6,58			H
32	10		40 043 032	181,00	7,54			H
40	10		40 043 040	229,00	9,54			H
50	10		40 043 050	383,00	15,96			H
63	10		40 043 063	518,00	21,58			H

40 070



### PE80 spojka polyfuzní

d mm	PN bar	m kg	objednáací kód	cena Kč	cena EUR	balení [ks]		sk
						MB	VB	
20	10		40 070 020	87,00	3,63			H
25	10		40 070 025	91,00	3,79			H
32	10		40 070 032	120,00	5,00			H
40	10		40 070 040	147,00	6,13			H
50	10		40 070 050	229,00	9,54			H
63	10		40 070 063	303,00	12,63			H

40 071



### PE80 redukce polyfuzní vnější x vnitřní

d x d mm	PN bar	m kg	objednáací kód	cena Kč	cena EUR	balení [ks]		sk
						MB	VB	
25 x 20	10		40 071 025 020	118,00	4,92			H
32 x 25	10		40 071 032 025	137,00	5,71			H
40 x 20	10		40 071 040 020	201,00	8,38			H
40 x 25	10		40 071 040 025	201,00	8,38			H
40 x 32	10		40 071 040 032	201,00	8,38			H
50 x 32	10		40 071 050 032	281,00	11,71			H
50 x 40	10		40 071 050 040	281,00	11,71			H
63 x 20	10		40 071 063 020	383,00	15,96			H
63 x 25	10		40 071 063 025	325,00	13,54			H
63 x 32	10		40 071 063 032	325,00	13,54			H
63 x 40	10		40 071 063 040	325,00	13,54			H
63 x 50	10		40 071 063 050	325,00	13,54			H

## PE Polyfuzní tvarovky

40 109



### PE80 víčko polyfuzní

d mm	PN bar	m kg	objednáací kód	cena Kč	cena EUR	balení [ks]		sk
						MB	VB	
20	10		40 109 020	201,00	8,38			H
25	10		40 109 025	201,00	8,38			H
32	10		40 109 032	201,00	8,38			H
40	10		40 109 040	217,00	9,04			H
50	10		40 109 050	281,00	11,71			H
63	10		40 109 063	356,00	14,83			H

40 100



### PE100 hadicový trn polyfuzní

d x d mm	PN bar	m kg	objednáací kód	cena Kč	cena EUR	balení [ks]		sk
						MB	VB	
20 x 20	10		40 100 020	120,00	5,00			H
25 x 25	10		40 100 025	150,00	6,25			H
32 x 32	10		40 100 032	181,00	7,54			H
40 x 40	10		40 100 040	306,00	12,75			H
50 x 50	10		40 100 050	533,00	22,21			H
63 x 60	10		40 100 063	612,00	25,50			H

40 077



### PE80 přechod polyfuzní x vnitřní závit

d x Rp mm x inch	PN bar	m kg	objednáací kód	cena Kč	cena EUR	balení [ks]		sk
						MB	VB	
20 x 1/2"	10		40 077 020 012	137,00	5,71			H
25 x 3/4"	10		40 077 025 034	173,00	7,21			H
32 x 1"	10		40 077 032 100	219,00	9,13			H
40 x 5/4"	10		40 077 040 114	270,00	11,25			H
50 x 6/4"	10		40 077 050 112	438,00	18,25			H
63 x 2"	10		40 077 063 200	598,00	24,92			H

40 079



### PE80 přechod polyfuzní vnější x vnitřní závit

d x Rp mm x inch	PN bar	m kg	objednáací kód	cena Kč	cena EUR	balení [ks]		sk
						MB	VB	
20 x 3/8"	10		40 079 020 038	177,00	7,38			H
25 x 1/2"	10		40 079 025 012	198,00	8,25			H
32 x 3/4"	10		40 079 032 034	223,00	9,29			H
40 x 1"	10		40 079 040 100	284,00	11,83			H
50 x 5/4"	10		40 079 050 114	385,00	16,04			H

40 110



### PE80 šroubení polyfuzní

d mm	PN bar	m kg	objednáací kód	cena Kč	cena EUR	balení [ks]		sk
						MB	VB	
20	10		40 110 020	---	---			-
25	10		40 110 025	703,00	29,29			H
32	10		40 110 032	792,00	33,00			H
40	10		40 110 040	1 220,00	50,83			H
50	10		40 110 050	1 346,00	56,08			H
63	10		40 110 063	1 616,00	67,33			H

## PE100 Elektrotvarovky

40 060



### Elektrospojka PE100 SDR11

d mm	PN bar	m kg	objednáací kód	cena Kč	cena EUR	balení [ks]		sk
						MB	VB	
20	16		40 060 020 11	135,00	5,63		50	D
25	16		40 060 025 11	132,00	5,50		50	D
32	16		40 060 032 11	123,00	5,13		50	D
40	16		40 060 040 11	136,00	5,67		50	D
50	16		40 060 050 11	204,00	8,50		10	D
63	16		40 060 063 11	211,00	8,79		10	D
75	16		40 060 075 11	284,10	11,36		12	A
90	16		40 060 090 11	304,50	12,18		10	A
110	16		40 060 110 11	377,60	15,10		5	A
125	16		40 060 125 11	532,40	21,30		5	A
140	16		40 060 140 11	661,70	26,47		5	A
160	16		40 060 160 11	743,30	29,73		6	A
180	16		40 060 180 11	1 029,10	41,16		5	A
200	16		40 060 200 11	1 284,30	51,37		4	A
225	16		40 060 225 11	1 547,90	61,92		3	A
250	16		40 060 250 11	2 389,90	95,60		2	A
280	16		40 060 280 11	3 413,90	136,56		1	A
315	16		40 060 315 11	3 908,90	156,36		1	A
355	16		40 060 355 11	6 616,90	264,68		1	A
400	16		40 060 400 11	8 770,40	350,82			A
450	16		40 060 450 11	12 303,30	492,13			A
500	16		40 060 500 11	16 501,40	660,06			A
560	16		40 060 560 11	22 538,30	901,53			A
630	16		40 060 630 11	41 148,90	1 645,96			A

40 060



### Elektrospojka PE100 SDR17

d mm	PN bar	m kg	objednáací kód	cena Kč	cena EUR	balení [ks]		sk
						MB	VB	
160	10		40 060 160 171	705,90	28,24		6	A
180	10		40 060 180 171	973,00	38,92		5	A
200	10		40 060 200 171	1 035,90	41,44		4	A
225	10		40 060 225 171	1 364,20	54,57		3	A
250	10		40 060 250 171	2 070,10	82,80		2	A
280	10		40 060 280 171	2 752,20	110,09		1	A
315	10		40 060 315 171	3 289,70	131,59		1	A
355	10		40 060 355 171	5 171,00	206,84		1	A
400	10		40 060 400 171	6 412,80	256,51		1	A
450	10		40 060 450 171	10 132,90	405,32		1	A
500	10		40 060 500 171	11 995,50	479,82		1	A
560	10		40 060 560 171	14 062,20	562,49		1	A
630	10		40 060 630 171	19 231,50	769,26		1	A

elektrospojky dodáváme v následujícím rozsahu:

SDR26 PN6: d110 - d1600

SDR17 PN10: d90 - d1200

SDR11 PN16: d20 - d1200

SDR7,4 PN25: d32 - d500

40 063



### Elektrospojka PE100 SDR11 pro náviny

d mm	PN bar	m kg	objednáací kód	cena Kč	cena EUR	balení [ks]		sk
						MB	VB	
32	16		40 063 032	279,00	11,63			E
40	16		40 063 040	292,00	12,17			E
50	16		40 063 050	448,00	18,67			E
63	16		40 063 063	472,00	19,67			E

Svařování bez nutnosti použití držáků či fixačních zařízení

40 062



## Elektroredukcce PE100 SDR11

d x d mm x mm	PN bar	m kg	objednáací kód	cena Kč	cena EUR	balení [ks]		sk
						MB	VB	
25 x 20	16		40 062 025 020	381,00	15,88		20	D
32 x 20	16		40 062 032 020	381,00	15,88		20	D
32 x 25	16		40 062 032 025	203,00	8,46		20	D
40 x 20	16		40 062 040 020	489,00	20,38		20	D
40 x 25	16		40 062 040 025	339,00	14,13		20	D
40 x 32	16		40 062 040 032	229,00	9,54		20	D
50 x 32	16		40 062 050 032	286,00	11,92		10	D
50 x 40	16		40 062 050 040	281,00	11,71		15	D
63 x 32	16		40 062 063 032	369,00	15,38		10	D
63 x 40	16		40 062 063 040	369,00	15,38		10	D
63 x 50	16		40 062 063 050	369,00	15,38		10	D
75 x 50	16		40 062 075 050I	498,40	19,94			A
75 x 63	16		40 062 075 063I	498,40	19,94			A
90 x 50	16		40 062 090 050I	537,50	21,50			A
90 x 63	16		40 062 090 063I	537,50	21,50			A
90 x 75	16		40 062 090 075I	537,50	21,50			A
110 x 63	16		40 062 110 063I	724,60	28,98			A
110 x 75	16		40 062 110 075I	724,60	28,98			A
110 x 90	16		40 062 110 090I	724,60	28,98			A
125 x 63	16		40 062 125 063I	1 182,20	47,29			A
125 x 90	16		40 062 125 090I	1 182,20	47,29			A
125 x 110	16		40 062 125 110I	1 182,20	47,29			A
140 x 90	16		40 062 140 090I	1 406,70	56,27			A
160 x 90	16		40 062 160 090I	1 551,30	62,05			A
160 x 110	16		40 062 160 110I	1 551,30	62,05			A
160 x 125	16		40 062 160 125I	1 551,30	62,05			A
180 x 90	16		40 062 180 090I	2 253,80	90,15			A
180 x 125	16		40 062 180 125I	2 253,80	90,15			A
180 x 140	16		40 062 180 140I	2 253,80	90,15			A
180 x 160	16		40 062 180 160I	2 253,80	90,15			A
200 x 160	16		40 062 200 160I	3 308,40	132,34			A
200 x 180	16		40 062 200 180I	3 308,40	132,34			A
225 x 160	16		40 062 225 160I	4 449,80	177,99			A
225 x 200	16		40 062 225 200	12 645,00	526,88			D
250 x 160	16		40 062 250 160	15 338,00	639,08		2	D
250 x 180	16		40 062 250 180I	7 441,90	297,68			A
250 x 200	16		40 062 250 200	15 462,00	644,25		2	D
250 x 225	16		40 062 250 225	15 294,00	637,25			D
315 x 200	16		40 062 315 200I	13 026,30	521,05			A
315 x 250	16		40 062 315 250I	13 026,30	521,05			A

## PE100 Elektrotvarovky

40 001



### Elektrokoleno 90° PE100 SDR11

d mm	PN bar	m kg	objednáací kód	cena Kč	cena EUR	balení [ks]		sk
						MB	VB	
20	16		40 001 020	538,00	22,42		10	D
25	16		40 001 025	381,00	15,88		10	D
32	16		40 001 032	313,00	13,04		10	D
40	16		40 001 040	374,00	15,58		10	D
50	16		40 001 050	463,00	19,29		10	D
63	16		40 001 063	526,00	21,92			D
75	16		40 001 075I	724,60	28,98			A
90	16		40 001 090I	753,50	30,14			A
110	16		40 001 110I	1 025,70	41,03			A
125	16		40 001 125I	1 449,30	57,97			A
140	16		40 001 140I	2 277,60	91,10			A
160	16		40 001 160I	2 522,60	100,90			A
180	16		40 001 180I	3 391,80	135,67			A
200	16		40 001 200I	4 963,50	198,54			A
225	16		40 001 225I	6 162,70	246,51			A
250	16		40 001 250I	10 753,70	430,15			A
280	16		40 001 280F	24 185,00	1 007,71			E
315	16		40 001 315I	16 130,60	645,22			A

40 011



### Elektrokoleno 45° PE100 SDR11

d mm	PN bar	m kg	objednáací kód	cena Kč	cena EUR	balení [ks]		sk
						MB	VB	
20	16		40 011 020I	391,60	15,66			D
25	16		40 011 025I	391,60	15,66			D
32	16		40 011 032	379,00	15,79		20	D
40	16		40 011 040	374,00	15,58		10	D
50	16		40 011 050	463,00	19,29		10	D
63	16		40 011 063	530,00	22,08			D
75	16		40 011 075I	724,60	28,98			A
90	16		40 011 090I	753,50	30,14			A
110	16		40 011 110I	1 025,70	41,03			A
125	16		40 011 125I	1 449,30	57,97		6	A
140	16		40 011 140I	2 277,60	91,10			A
160	16		40 011 160I	2 522,60	100,90			A
180	16		40 011 180I	3 391,80	135,67		1	A
200	16		40 011 200I	4 963,50	198,54		1	A
225	16		40 011 225I	6 162,70	246,51		1	A
250	16		40 011 250I	10 132,90	405,32		1	A
280	16		40 011 280F	23 693,00	987,21			E
315	16		40 011 315I	15 302,20	612,09		1	A

40 017



### Elektrokoleno 30° PE100 SDR11

d mm	PN bar	m kg	objednáací kód	cena Kč	cena EUR	balení [ks]		sk
						MB	VB	
90	16		40 017 090 11	1 371,00	57,13			E
110	16		40 017 110 11	2 022,00	84,25			E
125	16		40 017 125 11	2 918,00	121,58			E
160	16		40 017 160 11	5 262,00	219,25			E
180	16		40 017 180 11	7 068,00	294,50			E
200	16		40 017 200 11	9 648,00	402,00			E
225	16		40 017 225 11	10 436,00	434,83			E

40 018



### Elektrokoleno 22,5° PE100 SDR11

d mm	PN bar	m kg	objednáací kód	cena Kč	cena EUR	balení [ks]		sk
						MB	VB	
90	16		40 018 090 11I	867,50	34,70			A
125	16		40 018 125 11I	1 779,30	71,17			A
180	16		40 018 180 11I	3 908,90	156,36			A
250	16		40 018 250 11I	12 820,40	512,82			A
315	16		40 018 315 11I	19 437,30	777,49			A



## PE100 Elektrotvarovky

40 019



### Elektrokoleno 11,25° PE100 SDR11

d mm	PN bar	m kg	objednáací kód	cena Kč	cena EUR	balení [ks]		sk
						MB	VB	
90	16		40 019 090 111	867,50	34,70			A
110	16		40 019 110 11	2 032,00	84,67			E
125	16		40 019 125 111	1 779,30	71,17			A
160	16		40 019 160 11	5 236,00	218,17			E
180	16		40 018 180 111	3 908,90	156,36			A
225	16		40 019 225 11	11 788,00	491,17			E
250	16		40 019 250 111	12 820,40	512,82			A
315	16		40 019 315 111	19 437,30	777,49			A

40 040



### Elektro T-kus PE100 SDR11

d mm	PN bar	m kg	objednáací kód	cena Kč	cena EUR	balení [ks]		sk
						MB	VB	
20	16		40 040 020	584,00	24,33		10	D
25	16		40 040 025	379,00	15,79		10	D
32	16		40 040 032	333,00	13,88		10	D
40	16		40 040 040	371,00	15,46		10	D
50	16		40 040 050	490,00	20,42		5	D
63	16		40 040 063	536,00	22,33			D
75	16		40 040 075I	809,70	32,39			A
90	16		40 040 090I	893,00	35,72			A
110	16		40 040 110I	1 233,20	49,33			A
125	16		40 040 125I	1 718,00	68,72		4	A
140	16		40 040 140I	2 878,10	115,12			A
160	16		40 040 160I	3 000,60	120,02			A
180	16		40 040 180I	4 449,80	177,99		2	A
200	16		40 040 200I	6 412,80	256,51		1	A
225	16		40 040 225I	8 066,20	322,65		1	A
250	16		40 040 250I	13 339,30	533,57		1	A
280	16		40 040 280F	27 430,00	1 142,92			E
315	16		40 040 315I	20 059,90	802,40		1	A

40 041



### Elektro T-kus redukovaný PE100 SDR11

d x d mm x mm	PN bar	m kg	objednáací kód	cena Kč	cena EUR	balení [ks]		sk
						MB	VB	
90 x 63	16		40 041 090 063I	1 013,80	40,55			A
90 x 75	16		40 041 090 075I	1 013,80	40,55			A
110 x 63	16		40 041 110 063I	1 345,50	53,82			A
110 x 90	16		40 041 110 090	4 046,00	168,58			D
125 x 63	16		40 041 125 063I	1 860,90	74,44			A
125 x 90	16		40 041 125 090I	1 860,90	74,44			A
140 x 110	16		40 041 140 110I	3 102,60	124,10			A
160 x 63	16		40 041 160 063	8 994,00	374,75			D
160 x 90	16		40 041 160 090	8 823,00	367,63			D
160 x 110	16		40 041 160 110I	3 289,70	131,59			A
180 x 90	16		40 041 180 090I	4 861,50	194,46			A
180 x 125	16		40 041 180 125I	4 861,50	194,46			A
200 x 90	16		40 041 200 090I	7 237,80	289,51			A
200 x 110	16		40 041 200 110	21 109,00	879,54			D
200 x 125	16		40 041 200 125I	7 237,80	289,51			A
200 x 160	16		40 041 200 160	20 939,00	872,46			D
200 x 180	16		40 041 200 180I	7 237,80	289,51			A
225 x 90	16		40 041 225 090	24 348,00	1 014,50			D
225 x 110	16		40 041 225 110I	8 685,30	347,41			A
225 x 160	16		40 041 225 160I	8 685,30	347,41			A
250 x 110	16		40 041 250 110	28 018,00	1 167,42			D
250 x 125	16		40 041 250 125I	14 888,80	595,55			A
250 x 160	16		40 041 250 160	28 018,00	1 167,42			D
250 x 180	16		40 041 250 180I	14 888,80	595,55			A
315 x 125	16		40 041 315 125I	21 298,20	851,93			A
315 x 180	16		40 041 315 180I	21 298,20	851,93			A

## PE100 Elektrotvarovky

40 141



### Elektro sedlo Saturn PE100 SDR11

d x d mm x mm	PN bar	m kg	objednáací kód	cena Kč	cena EUR	balení [ks]		sk
						MB	VB	
160 x 90	16		40 141 160 090	5 501,00	229,21			D
160 x 110	16		40 141 160 110	5 689,00	237,04			D
200 x 110	16		40 141 200 110	6 106,00	254,42			D
225 x 90	16		40 141 225 090	6 173,00	257,21			D
225 x 110	16		40 141 225 110	6 081,00	253,38			D
250 x 110	16		40 141 250 110	5 692,00	237,17			D

40 142



### Elektro sedlo Topload PE100 SDR11

d x d mm x mm	PN bar	m kg	objednáací kód	cena Kč	cena EUR	balení [ks]		sk
						MB	VB	
280 x 90	16		40 142 280 090	10 522,00	438,42			D
280 x 110	16		40 142 280 110	10 522,00	438,42			D
315 x 90	16		40 142 315 090	11 480,00	478,33			D
315 x 110	16		40 142 315 110	11 480,00	478,33			D
315 x 160	16		40 142 315 160	28 139,00	1 172,46			D
400 x 110	16		40 142 400 110	11 480,00	478,33			D
500-630 x 110	16		40 142 500 110	11 834,00	493,08			D
560 x 160	16		40 142 560 160	45 024,00	1 876,00			D
560 x 225	16		40 142 560 225	51 780,00	2 157,50			D

40 140



Elektro sedlo PE100 SDR11

d x d mm x mm	PN bar	m kg	objednáací kód	cena Kč	cena EUR	balení [ks]		sk
						MB	VB	
63 x 32	16		40 140 063 032	615,80	24,63			A
75 x 32	16		40 140 075 032	637,90	25,52			A
90 x 32	16		40 140 090 032	651,50	26,06			A
90 x 63	16		40 140 090 063	651,50	26,06			A
110 x 32	16		40 140 110 032	690,60	27,62			A
110 x 63	16		40 140 110 063	690,60	27,62			A
125 x 32	16		40 140 125 032	728,00	29,12			A
125 x 63	16		40 140 125 063	728,00	29,12			A
140 x 32	16		40 140 140 032	809,70	32,39			A
140 x 63	16		40 140 140 063	809,70	32,39			A
140 x 90	16		40 140 140 090	2 379,70	95,19			A
160 x 32	16		40 140 160 032	809,70	32,39			A
160 x 63	16		40 140 160 063	809,70	32,39			A
160 x 110	16		40 140 160 110	2 483,50	99,34			A
180 x 32	16		40 140 180 032	962,80	38,51			A
180 x 63	16		40 140 180 063	962,80	38,51			A
180 x 110	16		40 140 180 110	2 585,50	103,42			A
200 x 32	16		40 140 200 032	974,70	38,99			A
200 x 63	16		40 140 200 063	974,70	38,99			A
200-225 x 110	16		40 140 200 110	3 308,40	132,34			A
225 x 32	16		40 140 225 032	1 029,10	41,16			A
225-280 x 63	16		40 140 225 063	1 530,90	61,24			A
250 x 32	16		40 140 250 032	1 541,10	61,64			A
280 x 32	16		40 140 280 032	1 774,10	70,96			A
280 x 110	16		40 140 280 110	---	---			-
315 x 32	16		40 140 315 032	2 008,90	80,36			A
315-450 x 63	16		40 140 315 063	2 316,80	92,67			A
315-400 x 110	16		40 140 315 110	6 616,90	264,68			A
450-500 x 110	16		40 140 450 110	13 235,50	529,42			A
450-500 x 160	16		40 140 450 160	13 648,80	545,95			A
500-900 x 63	16		40 140 500 063	11 371,20	454,85			A
560-630 x 110	16		40 140 560 110	18 195,60	727,82			A
560-630 x 160	16		40 140 560 160	18 610,60	744,42			A

40 120



Elektro sedlo PE100 SDR11 základní

d x d mm x mm	PN bar	m kg	objednáací kód	cena Kč	cena EUR	balení [ks]		sk
						MB	VB	
63 x 63	16		40 120 063 063	1 302,00	54,25			D
75 x 63	16		40 120 075 063	1 492,00	62,17			D
90 x 63	16		40 120 090 063	1 498,00	62,42			D
110 x 63	16		40 120 110 063	1 649,00	68,71			D
125 x 63	16		40 120 125 063	2 164,00	90,17			D
140 x 63	16		40 120 140 063	3 058,00	127,42			D
160 x 63	16		40 120 160 063	3 238,00	134,92			D
180 x 63	16		40 120 180 063	3 742,00	155,92			D
200 x 63	16		40 120 200 063	4 612,00	192,17			D
225 x 63	16		40 120 225 063	4 940,00	205,83			D
250 x 63	16		40 120 250 063	7 385,00	307,71			D
280 x 63	16		40 120 280 063	7 385,00	307,71			D
315-355 x 63	16		40 120 315 063	7 621,00	317,54			D
400 x 63	16		40 120 400 063	7 203,00	300,13			D

40 121



## Elektro sedlo PE100 SDR11 navrtávací T-kus odbočkový

d x d mm x mm	PN bar	m kg	objednáací kód	cena Kč	cena EUR	balení [ks]		sk
						MB	VB	
63 x 20	16		40 121 063 020	2 123,00	88,46			D
63 x 25	16		40 121 063 025	2 231,00	92,96			D
63 x 32	16		40 121 063 032	1 333,00	55,54			D
63 x 40	16		40 121 063 040	1 117,00	46,54			D
63 x 63	16		40 121 063 063	1 314,00	54,75			D
75 x 20	16		40 121 075 020	2 288,00	95,33			D
75 x 25	16		40 121 075 025	2 408,00	100,33			D
75 x 32	16		40 121 075 032	2 408,00	100,33			D
75 x 40	16		40 121 075 040	2 614,00	108,92			D
75 x 63	16		40 121 075 063	2 614,00	108,92			D
90 x 20	16		40 121 090 020	2 293,00	95,54			D
90 x 25	16		40 121 090 025	1 268,00	52,83			D
90 x 32	16		40 121 090 032	1 292,00	53,83			D
90 x 40	16		40 121 090 040	1 283,00	53,46			D
90 x 63	16		40 121 090 063	1 214,00	50,58			D
110 x 20	16		40 121 110 020	2 527,00	105,29			D
110 x 25	16		40 121 110 025	1 333,00	55,54			D
110 x 32	16		40 121 110 032	1 333,00	55,54			D
110 x 40	16		40 121 110 040	1 301,00	54,21			D
110 x 63	16		40 121 110 063	1 576,00	65,67			D
125 x 20	16		40 121 125 020	2 874,00	119,75			D
125 x 25	16		40 121 125 025	3 020,00	125,83			D
125 x 32	16		40 121 125 032	3 020,00	125,83			D
125 x 40	16		40 121 125 040	3 227,00	134,46			D
125 x 63	16		40 121 125 063	3 227,00	134,46			D
140 x 20	16		40 121 140 020	3 927,00	163,63			D
140 x 25	16		40 121 140 025	3 833,00	159,71			D
140 x 32	16		40 121 140 032	3 833,00	159,71			D
140 x 40	16		40 121 140 040	4 039,00	168,29			D
140 x 63	16		40 121 140 063	4 137,00	172,38			D
160 x 20	16		40 121 160 020	4 002,00	166,75			D
160 x 25	16		40 121 160 025	1 512,00	63,00			D
160 x 32	16		40 121 160 032	1 512,00	63,00			D
160 x 40	16		40 121 160 040	1 978,00	82,42			D
160 x 63	16		40 121 160 063	2 384,00	99,33			D
180 x 20	16		40 121 180 020	4 545,00	189,38			D
180 x 25	16		40 121 180 025	4 545,00	189,38			D
180 x 32	16		40 121 180 032	4 488,00	187,00			D
180 x 40	16		40 121 180 040	4 695,00	195,63			D
180 x 63	16		40 121 180 063	4 695,00	195,63			D
200 x 20	16		40 121 200 020	5 355,00	223,13			D
200 x 25	16		40 121 200 025	5 355,00	223,13			D
200 x 32	16		40 121 200 032	5 289,00	220,38			D
200 x 40	16		40 121 200 040	5 494,00	228,92			D
200 x 63	16		40 121 200 063	5 494,00	228,92			D
225 x 20	16		40 121 225 020	5 661,00	235,88			D
225 x 25	16		40 121 225 025	2 123,00	88,46			D
225 x 32	16		40 121 225 032	2 112,00	88,00			D
225 x 40	16		40 121 225 040	3 207,00	133,63			D
225 x 63	16		40 121 225 063	2 632,00	109,67			D
250 x 20	16		40 121 250 020	7 932,00	330,50			D
250 x 25	16		40 121 250 025	7 834,00	326,42			D
250 x 32	16		40 121 250 032	8 532,00	355,50			D
250 x 40	16		40 121 250 040	8 043,00	335,13			D
250 x 63	16		40 121 250 063	8 043,00	335,13			D
280 x 63	16		40 121 280 063	8 043,00	335,13			D
315-355 x 63	16		40 121 315 063	7 129,00	297,04			D
400 x 63	16		40 121 400 063	7 804,00	325,17			D

40 123



Elektro sedlo PE100 SDR11 navrtávací T-kus odbočkový s uzavíracím ventilem

d x d mm x mm	PN bar	m kg	objednáací kód	cena Kč	cena EUR	balení [ks]		sk
						MB	VB	
63 x 32	16		40 123 063 032	5 174,00	215,58			D
63 x 63	16		40 123 063 063	5 325,00	221,88			D
75 x 32	16		40 123 075 032	5 696,00	237,33			D
75 x 63	16		40 123 075 063	6 273,00	261,38			D
90 x 32	16		40 123 090 032	5 335,00	222,29			D
90 x 63	16		40 123 090 063	5 435,00	226,46			D
110 x 32	16		40 123 110 032	5 775,00	240,63			D
110 x 63	16		40 123 110 063	5 892,00	245,50			D
125 x 32	16		40 123 125 032	6 049,00	252,04			D
125 x 63	16		40 123 125 063	6 280,00	261,67			D
140 x 32	16		40 123 140 032	6 971,00	290,46			D
140 x 63	16		40 123 140 063	6 785,00	282,71			D
160 x 32	16		40 123 160 032	6 868,00	286,17			D
160 x 63	16		40 123 160 063	7 432,00	309,67			D
180 x 32	16		40 123 180 032	7 601,00	316,71			D
180 x 63	16		40 123 180 063	7 601,00	316,71			D
200 x 32	16		40 123 200 032	7 905,00	329,38			D
200 x 63	16		40 123 200 063	7 905,00	329,38			D
225 x 32	16		40 123 225 032	7 683,00	320,13			D
225 x 63	16		40 123 225 063	8 148,00	339,50			D
250 x 32	16		40 123 250 032	11 238,00	468,25			D
250 x 63	16		40 123 250 063	11 238,00	468,25			D
280 x 32	16		40 123 280 032	11 147,00	464,46			D
280 x 63	16		40 123 280 063	11 717,00	488,21			D
315-355 x 32	16		40 123 315 032	11 383,00	474,29			D
315-355 x 63	16		40 123 315 063	11 383,00	474,29			D
400 x 32	16		40 123 400 032	10 961,00	456,71			D
400 x 63	16		40 123 400 063	10 961,00	456,71			D

40 190



zemní souprava teleskopická dvoudílná

Rd m	PN bar	m kg	objednáací kód	cena Kč	cena EUR	balení [ks]		sk
						MB	VB	
0,87 - 1,32			40 190 001	1 318,00	54,92			D
1,07 - 1,57			40 190 002	1 337,00	55,71			D
1,22 - 2,02			40 190 003	1 446,00	60,25			D
klíč REN 14x14			40 190 010	569,00	23,71			D

40 105



Elektrovíčko PE100 SDR11

d mm	PN bar	m kg	objednáací kód	cena Kč	cena EUR	balení [ks]		sk
						MB	VB	
20	16		40 105 020	370,00	15,42		50	D
25	16		40 105 025	226,00	9,42		50	D
32	16		40 105 032	217,00	9,04		50	D
40	16		40 105 040	266,00	11,08		50	D
50	16		40 105 050	357,00	14,88		10	D
63	16		40 105 063	414,00	17,25		10	D

40 106



Elektrovíčko PE100 SDR11 KIT

d mm	PN bar	m kg	objednáací kód	cena Kč	cena EUR	balení [ks]		sk
						MB	VB	
75	16		40 106 075	1 184,00	49,33		6	D
90	16		40 106 090	966,00	40,25		5	D
110	16		40 106 110	1 210,00	50,42		3	D
125	16		40 106 125	1 609,00	67,04		3	D
140	16		40 106 140	2 401,00	100,04		3	D
160	16		40 106 160	1 980,00	82,50		1	D
180	16		40 106 180	4 319,00	179,96		1	D
200	16		40 106 200	5 329,00	222,04		1	D
225	16		40 106 225	4 154,00	173,08		1	D

## PE100 Elektrotvarovky

40 073

### přechod PE100 SDR11 x Ms vnitřní závit

pro elektrotvarovky



d x G mm x inch	PN bar	m kg	objednáací kód	cena Kč	cena EUR	balení [ks]		sk
						MB	VB	
20 x 1/2"	16		40 073 020 012I	268,40	10,74			A
25 x 3/4"	16		40 073 025 034I	268,40	10,74			A
32 x 1"	16		40 073 032 100I	340,20	13,61			A
40 x 5/4"	16		40 073 040 114I	472,50	18,90			A
50 x 6/4"	16		40 073 050 112I	623,70	24,95			A
63 x 1"	16		40 073 063 100	1 672,00	69,67		12	D
63 x 5/4"	16		40 073 063 114	1 672,00	69,67		12	D
63 x 6/4"	16		40 073 063 112	1 672,00	69,67		12	D
63 x 2"	16		40 073 063 200I	737,10	29,48			A

40 074

### přechod PE100 SDR11 x Ms převlečná matice

pro elektrotvarovky



d x G mm x inch	PN bar	m kg	objednáací kód	cena Kč	cena EUR	balení [ks]		sk
						MB	VB	
25 x 3/4"	16		40 074 025 034	1 287,00	53,63			D
32 x 1"	16		40 074 032 100	1 410,00	58,75			D
50 x 6/4"	16		40 074 050 112	1 979,00	82,46			D
63 x 1"	16		40 074 063 100	2 455,00	102,29			D
63 x 2"	16		40 074 063 200	2 674,00	111,42			D

40 075

### přechod PE100 SDR11 x Ms vnější závit

pro elektrotvarovky



d x G mm x inch	PN bar	m kg	objednáací kód	cena Kč	cena EUR	balení [ks]		sk
						MB	VB	
20 x 1/2"	16		40 075 020 012I	321,30	12,85			A
25 x 3/4"	16		40 075 025 034I	321,30	12,85			A
32 x 1"	16		40 075 032 100I	374,20	14,97			A
32 x 5/4"	16		40 075 032 114	1 145,00	47,71		30	D
32 x 6/4"	16		40 075 032 112	1 145,00	47,71		30	D
40 x 1"	16		40 075 040 100	1 090,00	45,42		20	D
40 x 5/4"	16		40 075 040 114I	604,80	24,19			A
40 x 6/4"	16		40 075 040 112	1 204,00	50,17		20	D
50 x 1"	16		40 075 050 100	1 241,00	51,71		20	D
50 x 5/4"	16		40 075 050 114	1 241,00	51,71		20	D
50 x 6/4"	16		40 075 050 112I	774,90	31,00			A
63 x 5/4"	16		40 075 063 114	1 593,00	66,38		12	D
63 x 6/4"	16		40 075 063 112	1 593,00	66,38		12	D
63 x 2"	16		40 075 063 200I	926,10	37,04			A

40 076

### zemní přechod PE100 SDR11 x ocel



d x d mm x inch	PN bar	m kg	objednáací kód	cena Kč	cena EUR	balení [ks]		sk
						MB	VB	
32 x 1"	16		40 076 032 100	646,70	26,95		18	D
40 x 5/4"	16		40 076 040 114	0,00	0,00		12	D
50 x 6/4"	16		40 076 050 112	0,00	0,00		8	D
63 x 2"	16		40 076 063 200	0,00	0,00		6	D

40 211

### FLEXBLOCK elektro-navarovací pás pro vytvoření pevného bodu



d mm	PN bar	m kg	objednáací kód	cena Kč	cena EUR	balení [ks]		sk
						MB	VB	
d160 - d1600			40 211 001I	1 459,10	58,36			A

L=188mm, šířka 62mm

zachytí sílu až 40kN na jeden FLEXBLOCK

## PE100 Tvarovky na tupo

40 003



**koleno 90° PE100 SDR11, na tupo, dlouhé konce**

d mm	PN bar	m kg	objednáací kód	cena Kč	cena EUR	balení [ks]		sk
						MB	VB	
20	16		40 003 020 111	93,70	3,75		40	A
25	16		40 003 025 111	93,70	3,75		40	A
32	16		40 003 032 111	103,50	4,14		100	A
40	16		40 003 040 111	111,30	4,45		50	A
50	16		40 003 050 111	154,30	6,17		30	A
63	16		40 003 063 111	207,00	8,28		40	A
75	16		40 003 075 111	285,10	11,40		12	A
90	16		40 003 090 111	357,40	14,30		18	A
110	16		40 003 110 111	677,70	27,11		10	A
125	16		40 003 125 111	957,00	38,28		8	A
140	16		40 003 140 111	1 318,30	52,73		5	A
160	16		40 003 160 111	1 449,10	57,96		5	A
180	16		40 003 180 111	2 066,30	82,65		3	A
200	16		40 003 200 111	2 716,60	108,66		3	A
225	16		40 003 225 111	3 027,30	121,09		1	B
250	16		40 003 250 111	5 032,90	201,32		3	A
280	16		40 003 280 111	10 018,90	400,76		2	A
315	16		40 003 315 111	10 302,10	412,08		1	A
355	16		40 003 355 111	22 789,60	911,58			A
400	16		40 003 400 111	34 419,70	1 376,79			A

40 003



**koleno 90° PE100 SDR17, na tupo, dlouhé konce**

d mm	PN bar	m kg	objednáací kód	cena Kč	cena EUR	balení [ks]		sk
						MB	VB	
63	10		40 003 063 171	191,40	7,66			A
75	10		40 003 075 171	263,70	10,55			A
90	10		40 003 090 171	335,90	13,44		18	A
110	10		40 003 110 171	636,70	25,47		10	A
125	10		40 003 125 171	898,40	35,94		8	A
140	10		40 003 140 171	1 236,20	49,45		5	A
160	10		40 003 160 171	1 353,40	54,14		5	A
180	10		40 003 180 171	1 650,30	66,01		3	A
200	10		40 003 200 171	2 296,70	91,87		3	A
225	10		40 003 225 171	2 835,80	113,43		1	B
250	10		40 003 250 171	4 398,20	175,93		2	A
280	10		40 003 280 171	9 374,40	374,98		2	A
315	10		40 003 315 171	7 592,00	303,68		1	D
355	10		40 003 355 171	17 329,00	693,16			A
400	10		40 003 400 171	25 164,40	1 006,58			A

40 014



**koleno 45° PE100 SDR11, na tupo, dlouhé konce**

d mm	PN bar	m kg	objednáací kód	cena Kč	cena EUR	balení [ks]		sk
						MB	VB	
20	16		40 014 020 111	102,80	4,11			D
25	16		40 014 025 111	102,80	4,11			D
32	16		40 014 032 111	130,90	5,24		25	A
40	16		40 014 040 111	130,90	5,24		30	A
50	16		40 014 050 111	138,70	5,55		70	A
63	16		40 014 063 111	210,90	8,44		50	A
75	16		40 014 075 111	275,40	11,02		12	A
90	16		40 014 090 111	349,60	13,98		20	A
110	16		40 014 110 111	679,60	27,18		12	A
125	16		40 014 125 111	984,30	39,37		8	A
140	16		40 014 140 111	1 240,20	49,61		4	A
160	16		40 014 160 111	1 449,10	57,96		6	A
180	16		40 014 180 111	1 705,00	68,20		5	A
200	16		40 014 200 111	2 326,00	93,04		3	A
225	16		40 014 225 111	2 990,00	119,60		2	A
250	16		40 014 250 111	4 156,00	166,24		3	A
280	16		40 014 280 111	8 712,30	348,49		3	A
315	16		40 014 315 111	8 997,50	359,90		2	A
355	16		40 014 355 111	17 567,20	702,69			A
400	16		40 014 400 111	24 926,10	997,04			A

## PE100 Tvarovky na tupo

40 014



**koleno 45° PE100 SDR17, na tupo, dlouhé konce**

d mm	PN bar	m kg	objednáací kód	cena Kč	cena EUR	balení [ks]		sk
						MB	VB	
63	10		40 014 063 171	191,40	7,66			A
75	10		40 014 075 171	251,90	10,08			A
90	10		40 014 090 171	318,30	12,73		20	A
110	10		40 014 110 171	617,10	24,68		12	A
125	10		40 014 125 171	892,50	35,70		8	A
140	10		40 014 140 171	1 128,80	45,15		4	A
160	10		40 014 160 171	1 318,30	52,73		6	A
180	10		40 014 180 171	1 550,70	62,03		5	A
200	10		40 014 200 171	2 115,10	84,60		3	A
225	10		40 014 225 171	2 730,30	109,21		2	A
250	10		40 014 250 171	3 777,10	151,08		3	A
280	10		40 014 280 171	7 927,20	317,09		3	A
315	10		40 014 315 171	6 950,60	278,02		2	C
355	10		40 014 355 171	12 581,20	503,25		2	A
400	10		40 014 400 171	17 329,00	693,16		2	A

40 015



**koleno 30° PE100 SDR11, na tupo, dlouhé konce**

d mm	PN bar	m kg	objednáací kód	cena Kč	cena EUR	balení [ks]		sk
						MB	VB	
63	16		40 015 063 11	1 232,00	51,33		8	D
75	16		40 015 075 11	1 789,00	74,54		10	D
90	16		40 015 090 11	947,00	39,46		10	D
110	16		40 015 110 11	1 112,00	46,33		5	D
125	16		40 015 125 11	3 136,00	130,67		6	D
140	16		40 015 140 11	3 838,00	159,92		4	D
160	16		40 015 160 11	2 374,00	98,92		6	D
180	16		40 015 180 11	6 345,00	264,38		5	D
200	16		40 015 200 11	8 645,00	360,21		2	D
225	16		40 015 225 11	5 828,00	242,83		2	D
250	16		40 015 250 11	16 718,00	696,58		2	D
280	16		40 015 280 11	23 836,00	993,17		1	D
315	16		40 015 315 11	27 747,00	1 156,13		1	D

40 015



**koleno 30° PE100 SDR17, na tupo, dlouhé konce**

d mm	PN bar	m kg	objednáací kód	cena Kč	cena EUR	balení [ks]		sk
						MB	VB	
90	10		40 015 090 17	760,00	31,67		1	D
110	10		40 015 110 17	854,00	35,58		5	D
125	10		40 015 125 17	2 187,00	91,13		2	D
140	10		40 015 140 17	3 218,00	134,08		4	D
160	10		40 015 160 17	2 008,00	83,67		6	D
180	10		40 015 180 17	5 632,00	234,67		5	D
200	10		40 015 200 17	7 734,00	322,25		2	D
225	10		40 015 225 17	4 940,00	205,83		2	D
250	10		40 015 250 17	15 070,00	627,92		2	D
280	10		40 015 280 17	21 436,00	893,17		1	D
315	10		40 015 315 17	23 610,00	983,75		1	D

40 016



**koleno 15° PE100 SDR11, na tupo, dlouhé konce**

d mm	PN bar	m kg	objednáací kód	cena Kč	cena EUR	balení [ks]		sk
						MB	VB	
63	16		40 016 063 11	1 232,00	51,33		8	D
75	16		40 016 075 11	1 394,00	58,08		2	D
90	16		40 016 090 11	1 609,00	67,04		5	D
110	16		40 016 110 11	2 616,00	109,00		6	D
125	16		40 016 125 11	3 799,00	158,29		6	D
140	16		40 016 140 11	4 153,00	173,04		6	D
160	16		40 016 160 11	5 561,00	231,71		6	D
180	16		40 016 180 11	6 345,00	264,38		2	D
200	16		40 016 200 11	8 645,00	360,21		3	D
225	16		40 016 225 11	10 264,00	427,67		2	D
250	16		40 016 250 11	16 718,00	696,58		1	D
280	16		40 016 280 11	23 769,00	990,38		1	D
315	16		40 016 315 11	27 747,00	1 156,13		1	D



## PE100 Tvarovky na tupo

40 016



**koleno 15° PE100 SDR17, na tupo, dlouhé konce**

d mm	PN bar	m kg	objednáací kód	cena Kč	cena EUR	balení [ks]		sk
						MB	VB	
90	10		40 016 090 17	1 448,00	60,33		4	D
110	10		40 016 110 17	2 362,00	98,42		3	D
125	10		40 016 125 17	3 426,00	142,75		2	D
140	10		40 016 140 17	3 783,00	157,63		2	D
160	10		40 016 160 17	4 882,00	203,42		6	D
180	10		40 016 180 17	5 589,00	232,88		1	D
200	10		40 016 200 17	7 734,00	322,25		2	D
225	10		40 016 225 17	5 291,00	220,46		2	D
250	10		40 016 250 17	14 947,00	622,79		2	D
280	10		40 016 280 17	21 263,00	885,96		2	D
315	10		40 016 315 17	25 035,00	1 043,13		1	D

40 005



**oblouk 90° PE100 SDR11, na tupo, dlouhé konce**

d mm	PN bar	m kg	objednáací kód	cena Kč	cena EUR	R mm	sk
40	16		40 005 040 11	403,00	16,79	40	D
50	16		40 005 050 11	573,00	23,88	50	D
63	16		40 005 063 11	962,00	40,08	63	D
75	16		40 005 075 11	1 181,00	49,21	75	D
90	16		40 005 090 11	1 255,00	52,29	90	D
110	16		40 005 110 11	1 978,00	82,42	110	D
125	16		40 005 125 11	2 934,00	122,25	125	D
140	16		40 005 140 11	4 268,00	177,83	140	D
160	16		40 005 160 11	4 713,00	196,38	160	D
180	16		40 005 180 11	5 761,00	240,04	180	D
200	16		40 005 200 11	6 189,00	257,88	200	D
225	16		40 005 225 11	8 287,00	345,29	225	D
250	16		40 005 250 11	12 479,00	519,96	250	D
280	16		40 005 280 11	16 054,00	668,92	280	D
315	16		40 005 315 11	22 365,00	931,88	315	D
355	16		40 005 355 11	40 817,00	1 700,71	533	D
400	16		40 005 400 11	46 685,00	1 945,21	600	D
450	16		40 005 450 11	65 413,00	2 725,54	675	D
500	16		40 005 500 11	98 382,00	4 099,25	500	D
560	16		40 005 560 11	---	---	840	-
630	16		40 005 630 11	---	---	945	-

40 005



**oblouk 90° PE100 SDR17, na tupo, dlouhé konce**

d mm	PN bar	m kg	objednáací kód	cena Kč	cena EUR	R mm	sk
110	10		40 005 110 17	1 791,00	74,63	110	D
125	10		40 005 125 17	2 426,00	101,08	125	D
140	10		40 005 140 17	2 862,00	119,25	140	D
160	10		40 005 160 17	2 700,00	112,50	160	D
180	10		40 005 180 17	4 938,00	205,75	180	D
200	10		40 005 200 17	6 141,00	255,88	200	D
225	10		40 005 225 17	6 110,00	254,58	225	D
250	10		40 005 250 17	9 216,00	384,00	250	D
280	10		40 005 280 17	10 392,00	433,00	280	D
315	10		40 005 315 17	10 980,00	457,50	315	D
355	10		40 005 355 17	26 840,00	1 118,33	533	D
400	10		40 005 400 17	33 437,00	1 393,21	600	D
450	10		40 005 450 17	53 825,00	2 242,71	675	D
500	10		40 005 500 17	76 638,00	3 193,25	500	D
560	10		40 005 560 17	50 100,00	2 087,50	840	E
630	10		40 005 630 17	---	---	945	-

## PE100 Tvarovky na tupo

40 021



**oblouk 60° PE100 SDR11, na tupo, dlouhé konce**

d mm	PN bar	m kg	objednáací kód	cena Kč	cena EUR	R mm	sk
32	16		40 021 032 11	1 322,00	55,08	48	D
40	16		40 021 040 11	1 457,00	60,71	60	D
50	16		40 021 050 11	1 636,00	68,17	75	D
63	16		40 021 063 11	2 198,00	91,58	95	D
75	16		40 021 075 11	1 755,00	73,13	113	D
90	16		40 021 090 11	2 941,00	122,54	135	D
110	16		40 021 110 11	3 832,00	159,67	165	D
125	16		40 021 125 11	3 898,00	162,42	188	D
140	16		40 021 140 11	4 506,00	187,75	210	D
160	16		40 021 160 11	5 925,00	246,88	240	D
180	16		40 021 180 11	4 883,00	203,46	270	D
200	16		40 021 200 11	9 894,00	412,25	300	D
225	16		40 021 225 11	6 414,00	267,25	338	D
250	16		40 021 250 11	15 223,00	634,29	375	D
280	16		40 021 280 11	14 889,00	620,38	420	D
315	16		40 021 315 11	22 510,00	937,92	473	D
355	16		40 021 355 11	29 826,00	1 242,75	533	D
400	16		40 021 400 11	35 149,00	1 464,54	600	D
450	16		40 021 450 11	51 873,00	2 161,38	675	D
500	16		40 021 500 11	61 694,00	2 570,58	750	D
560	16		40 021 560 11	---	---	840	-
630	16		40 021 630 11	---	---	945	-

40 021



**oblouk 60° PE100 SDR17, na tupo, dlouhé konce**

d mm	PN bar	m kg	objednáací kód	cena Kč	cena EUR	R mm	sk
90	10		40 021 090 17	2 401,00	100,04	135	D
110	10		40 021 110 17	3 029,00	126,21	165	D
125	10		40 021 125 17	3 177,00	132,38	187	D
140	10		40 021 140 17	2 664,00	111,00	210	D
160	10		40 021 160 17	4 504,00	187,67	240	D
180	10		40 021 180 17	6 308,00	262,83	270	D
200	10		40 021 200 17	6 318,00	263,25	300	D
225	10		40 021 225 17	6 318,00	263,25	337	D
250	10		40 021 250 17	9 464,00	394,33	375	D
280	10		40 021 280 17	12 755,00	531,46	420	D
315	10		40 021 315 17	18 433,00	768,04	472	D
355	10		40 021 355 17	22 474,00	936,42	532	D
400	10		40 021 400 17	28 619,00	1 192,46	600	D
450	10		40 021 450 17	34 895,00	1 453,96	675	D
500	10		40 021 500 17	48 642,00	2 026,75	750	D
560	10		40 021 560 17	45 241,00	1 885,04	840	E
630	10		40 021 630 17	---	---	945	-

## PE100 Tvarovky na tupo

40 022



**oblouk 45° PE100 SDR11, na tupo, dlouhé konce**

d mm	PN bar	m kg	objednáací kód	cena Kč	cena EUR	R mm	sk
32	16		40 022 032 11	1 322,00	55,08	48	D
40	16		40 022 040 11	1 442,00	60,08	60	D
50	16		40 022 050 11	1 610,00	67,08	75	D
63	16		40 022 063 11	2 263,00	94,29	95	D
75	16		40 022 075 11	2 406,00	100,25	113	D
90	16		40 022 090 11	1 613,00	67,21	135	D
110	16		40 022 110 11	2 039,00	84,96	165	D
125	16		40 022 125 11	2 383,00	99,29	188	D
140	16		40 022 140 11	3 198,00	133,25	210	D
160	16		40 022 160 11	3 923,00	163,46	240	D
180	16		40 022 180 11	4 581,00	190,88	270	D
200	16		40 022 200 11	6 231,00	259,63	300	D
225	16		40 022 225 11	7 414,00	308,92	338	D
250	16		40 022 250 11	11 624,00	484,33	375	D
280	16		40 022 280 11	13 223,00	550,96	420	D
315	16		40 022 315 11	22 206,00	925,25	473	D
355	16		40 022 355 11	33 011,00	1 375,46	533	D
400	16		40 022 400 11	41 209,00	1 717,04	600	D
450	16		40 022 450 11	42 926,00	1 788,58	675	D
500	16		40 022 500 11	65 356,00	2 723,17	750	D
560	16		40 022 560 11	---	---	840	-
630	16		40 022 630 11	---	---	945	-

40 022



**oblouk 45° PE100 SDR17, na tupo, dlouhé konce**

d mm	PN bar	m kg	objednáací kód	cena Kč	cena EUR	R mm	sk
90	10		40 022 090 17	1 607,00	66,96	135	D
110	10		40 022 110 17	1 703,00	70,96	165	D
125	10		40 022 125 17	1 956,00	81,50	188	D
140	10		40 022 140 17	2 709,00	112,88	210	D
160	10		40 022 160 17	3 026,00	126,08	240	D
180	10		40 022 180 17	3 538,00	147,42	270	D
200	10		40 022 200 17	4 680,00	195,00	300	D
225	10		40 022 225 17	5 540,00	230,83	338	D
250	10		40 022 250 17	8 631,00	359,63	375	D
280	10		40 022 280 17	12 301,00	512,54	420	D
315	10		40 022 315 17	16 466,00	686,08	473	D
355	10		40 022 355 17	20 709,00	862,88	533	D
400	10		40 022 400 17	37 354,00	1 556,42	600	D
450	10		40 022 450 17	40 320,00	1 680,00	675	D
500	10		40 022 500 17	48 642,00	2 026,75	750	D
560	10		40 022 560 17	---	---	840	-
630	10		40 022 630 17	---	---	945	-

## PE100 Tvarovky na tupo

40 023



**oblouk 30° PE100 SDR11, na tupo, dlouhé konce**

d mm	PN bar	m kg	objednáací kód	cena Kč	cena EUR	R mm	sk
32	16		40 023 032 11	1 322,00	55,08	48	D
40	16		40 023 040 11	1 442,00	60,08	60	D
50	16		40 023 050 11	1 604,00	66,83	75	D
63	16		40 023 063 11	2 180,00	90,83	95	D
75	16		40 023 075 11	1 726,00	71,92	113	D
90	16		40 023 090 11	1 579,00	65,79	135	D
110	16		40 023 110 11	2 039,00	84,96	165	D
125	16		40 023 125 11	2 383,00	99,29	188	D
140	16		40 023 140 11	3 202,00	133,42	210	D
160	16		40 023 160 11	3 923,00	163,46	240	D
180	16		40 023 180 11	4 580,00	190,83	270	D
200	16		40 023 200 11	6 231,00	259,63	300	D
225	16		40 023 225 11	7 217,00	300,71	338	D
250	16		40 023 250 11	14 204,00	591,83	375	D
280	16		40 023 280 11	16 888,00	703,67	420	D
315	16		40 023 315 11	20 481,00	853,38	473	D
355	16		40 023 355 11	33 011,00	1 375,46	533	D
400	16		40 023 400 11	41 209,00	1 717,04	600	D
450	16		40 023 450 11	42 926,00	1 788,58	675	D
500	16		40 023 500 11	61 694,00	2 570,58	750	D
560	16		40 023 560 11	---	---	840	-
630	16		40 023 630 11	---	---	945	-

40 023



**oblouk 30° PE100 SDR17, na tupo, dlouhé konce**

d mm	PN bar	m kg	objednáací kód	cena Kč	cena EUR	R mm	sk
90	10		40 023 090 17	1 586,00	66,08	135	D
110	10		40 023 110 17	1 703,00	70,96	165	D
125	10		40 023 125 17	1 956,00	81,50	188	D
140	10		40 023 140 17	2 709,00	112,88	210	D
160	10		40 023 160 17	3 026,00	126,08	240	D
180	10		40 023 180 17	3 537,00	147,38	270	D
200	10		40 023 200 17	4 680,00	195,00	300	D
225	10		40 023 225 17	5 441,00	226,71	338	D
250	10		40 023 250 17	10 707,00	446,13	375	D
280	10		40 023 280 17	11 850,00	493,75	420	D
315	10		40 023 315 17	15 291,00	637,13	473	D
355	10		40 023 355 17	20 709,00	862,88	533	D
400	10		40 023 400 17	33 619,00	1 400,79	600	D
450	10		40 023 450 17	34 895,00	1 453,96	675	D
500	10		40 023 500 17	48 642,00	2 026,75	750	D
560	10		40 023 560 17	41 127,30	1 713,64	840	E
630	10		40 023 630 17	---	---	945	-

## PE100 Tvarovky na tupo

40 024



**oblouk 22° PE100 SDR11, na tupo, dlouhé konce**

d mm	PN bar	m kg	objednáací kód	cena Kč	cena EUR	R mm	sk
32	16		40 024 032 11	1 322,00	55,08	48	D
40	16		40 024 040 11	1 457,00	60,71	60	D
50	16		40 024 050 11	1 604,00	66,83	75	D
63	16		40 024 063 11	2 180,00	90,83	95	D
75	16		40 024 075 11	1 726,00	71,92	113	D
90	16		40 024 090 11	1 521,00	63,38	135	D
110	16		40 024 110 11	2 039,00	84,96	165	D
125	16		40 024 125 11	2 383,00	99,29	188	D
140	16		40 024 140 11	3 202,00	133,42	210	D
160	16		40 024 160 11	3 923,00	163,46	240	D
180	16		40 024 180 11	4 580,00	190,83	270	D
200	16		40 024 200 11	6 231,00	259,63	300	D
225	16		40 024 225 11	7 217,00	300,71	338	D
250	16		40 024 250 11	14 204,00	591,83	375	D
280	16		40 024 280 11	16 888,00	703,67	420	D
315	16		40 024 315 11	20 481,00	853,38	473	D
355	16		40 024 355 11	33 011,00	1 375,46	533	D
400	16		40 024 400 11	35 149,00	1 464,54	600	D
450	16		40 024 450 11	42 926,00	1 788,58	675	D
500	16		40 024 500 11	61 694,00	2 570,58	750	D
560	16		40 024 560 11	---	---	840	-
630	16		40 024 630 11	---	---	945	-

40 024



**oblouk 22° PE100 SDR17, na tupo, dlouhé konce**

d mm	PN bar	m kg	objednáací kód	cena Kč	cena EUR	R mm	sk
90	10		40 024 090 17	1 548,00	64,50	135	D
110	10		40 024 110 17	1 703,00	70,96	165	D
125	10		40 024 125 17	1 956,00	81,50	188	D
140	10		40 024 140 17	2 713,00	113,04	210	D
160	10		40 024 160 17	3 026,00	126,08	240	D
180	10		40 024 180 17	3 537,00	147,38	270	D
200	10		40 024 200 17	4 680,00	195,00	300	D
225	10		40 024 225 17	5 441,00	226,71	338	D
250	10		40 024 250 17	10 707,00	446,13	375	D
280	10		40 024 280 17	11 850,00	493,75	420	D
315	10		40 024 315 17	15 291,00	637,13	473	D
355	10		40 024 355 17	20 709,00	862,88	533	D
400	10		40 024 400 17	33 521,00	1 396,71	600	D
450	10		40 024 450 17	40 293,00	1 678,88	675	D
500	10		40 024 500 17	48 642,00	2 026,75	750	D
560	10		40 024 560 17	---	---	840	-
630	10		40 024 630 17	---	---	945	-

## PE100 Tvarovky na tupo

40 026



**oblouk 11° PE100 SDR11, na tupo, dlouhé konce**

d mm	PN bar	m kg	objednáací kód	cena Kč	cena EUR	R mm	sk
32	16		40 026 032 11	1 322,00	55,08	48	D
40	16		40 026 040 11	1 442,00	60,08	60	D
50	16		40 026 050 11	1 604,00	66,83	75	D
63	16		40 026 063 11	2 180,00	90,83	95	D
75	16		40 026 075 11	1 726,00	71,92	113	D
90	16		40 026 090 11	1 521,00	63,38	135	D
110	16		40 026 110 11	2 039,00	84,96	165	D
125	16		40 026 125 11	2 383,00	99,29	188	D
140	16		40 026 140 11	3 237,00	134,88	210	D
160	16		40 026 160 11	3 923,00	163,46	240	D
180	16		40 026 180 11	4 574,00	190,58	270	D
200	16		40 026 200 11	6 229,00	259,54	300	D
225	16		40 026 225 11	7 212,00	300,50	338	D
250	16		40 026 250 11	14 204,00	591,83	375	D
280	16		40 026 280 11	11 675,00	486,46	420	D
315	16		40 026 315 11	20 481,00	853,38	473	D
355	16		40 026 355 11	33 011,00	1 375,46	533	D
400	16		40 026 400 11	41 209,00	1 717,04	600	D
450	16		40 026 450 11	50 641,00	2 110,04	675	D
500	16		40 026 500 11	61 694,00	2 570,58	750	D
560	16		40 026 560 11	---	---	840	-
630	16		40 026 630 11	---	---	945	-

40 026



**oblouk 11° PE100 SDR17, na tupo, dlouhé konce**

d mm	PN bar	m kg	objednáací kód	cena Kč	cena EUR	R mm	sk
90	10		40 026 090 17	1 548,00	64,50	135	D
110	10		40 026 110 17	1 703,00	70,96	165	D
125	10		40 026 125 17	1 956,00	81,50	188	D
140	10		40 026 140 17	2 713,00	113,04	210	D
160	10		40 026 160 17	3 026,00	126,08	240	D
180	10		40 026 180 17	3 530,00	147,08	270	D
200	10		40 026 200 17	4 673,00	194,71	300	D
225	10		40 026 225 17	5 437,00	226,54	338	D
250	10		40 026 250 17	8 631,00	359,63	375	D
280	10		40 026 280 17	11 850,00	493,75	420	D
315	10		40 026 315 17	17 038,00	709,92	473	D
355	10		40 026 355 17	20 709,00	862,88	533	D
400	10		40 026 400 17	33 521,00	1 396,71	600	D
450	10		40 026 450 17	34 895,00	1 453,96	675	D
500	10		40 026 500 17	48 642,00	2 026,75	750	D
560	10		40 026 560 17	---	---	840	-
630	10		40 026 630 17	---	---	945	-

## PE100 Tvarovky na tupo

40 044

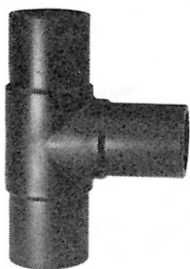

T-kus 90° PE100 SDR11, na tupo, dlouhé konce

d mm	PN bar	m kg	objednáací kód	cena Kč	cena EUR	balení [ks]		sk
						MB	VB	
20	16		40 044 020 111	117,20	4,69		30	A
25	16		40 044 025 111	117,20	4,69		25	A
32	16		40 044 032 111	130,90	5,24		20	A
40	16		40 044 040 111	154,30	6,17		80	A
50	16		40 044 050 111	173,80	6,95		20	A
63	16		40 044 063 111	232,40	9,30		25	A
75	16		40 044 075 111	320,30	12,81		16	A
90	16		40 044 090 111	507,80	20,31		7	A
110	16		40 044 110 111	748,00	29,92		7	A
125	16		40 044 125 111	1 136,70	45,47		4	A
140	16		40 044 140 111	1 654,20	66,17		4	A
160	16		40 044 160 111	2 097,50	83,90		4	A
180	16		40 044 180 111	2 827,90	113,12		3	A
200	16		40 044 200 111	3 632,60	145,30		2	A
225	16		40 044 225 111	4 890,30	195,61		1	A
250	16		40 044 250 111	7 288,60	291,54		2	A
280	16		40 044 280 111	12 702,30	508,09		1	A
315	16		40 044 315 111	13 034,30	521,37		1	A
355	16		40 044 355 111	24 404,70	976,19		1	A
400	16		40 044 400 111	34 968,50	1 398,74		1	A
450	16		40 044 450 111	45 530,30	1 821,21		1	A
500	16		40 044 500 111	63 406,10	2 536,24		1	A
560	16		40 044 560 111	83 037,70	3 321,51		1	A
630	16		40 044 630 111	111 975,30	4 479,01		1	A

40 045



T-kus 90° PE100 SDR11, na tupo, krátké konce

d mm	PN bar	m kg	objednáací kód	cena Kč	cena EUR	balení [ks]		sk
						MB	VB	
250	16		40 045 250 11	0,00	0,00		1	D
280	16		40 045 280 11	0,00	0,00		1	D
315	16		40 045 315 11	0,00	0,00		1	D
355	16		40 045 355 11	0,00	0,00		1	D
400	16		40 045 400 11	0,00	0,00		1	D
450	16		40 045 450 11	0,00	0,00		1	D
500	16		40 045 500 11	0,00	0,00		1	D

## PE100 Tvarovky na tupo

40 044

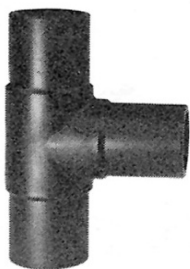

**T-kus 90° PE100 SDR17, na tupo, dlouhé konce**

d mm	PN bar	m kg	objednáací kód	cena Kč	cena EUR	balení [ks]		sk
						MB	VB	
63	10		40 044 063 171	222,70	8,91			A
75	10		40 044 075 171	300,80	12,03			A
90	10		40 044 090 171	476,50	19,06			A
110	10		40 044 110 171	710,90	28,44			A
125	10		40 044 125 171	1 076,10	43,04			A
140	10		40 044 140 171	1 564,30	62,57			A
160	10		40 044 160 171	1 982,30	79,29			A
180	10		40 044 180 171	2 669,80	106,79			A
200	10		40 044 200 171	3 396,30	135,85			A
225	10		40 044 225 171	4 620,80	184,83			A
250	10		40 044 250 171	6 790,60	271,62			A
280	10		40 044 280 171	10 164,80	406,59			C
315	10		40 044 315 171	12 298,00	491,92			A
355	10		40 044 355 171	19 586,60	783,46			A
400	10		40 044 400 171	30 029,30	1 201,17			A
450	10		40 044 450 171	37 862,80	1 514,51			A
500	10		40 044 500 171	53 531,70	2 141,27			A
560	10		40 044 560 171	66 066,10	2 642,64			A
630	10		40 044 630 171	91 916,00	3 676,64			A

40 045



**T-kus 90° PE100 SDR17, na tupo, krátké konce**

d mm	PN bar	m kg	objednáací kód	cena Kč	cena EUR	balení [ks]		sk
						MB	VB	
250	10		40 045 250 17	0,00	0,00		1	D
280	10		40 045 280 17	0,00	0,00		1	D
315	10		40 045 315 17	0,00	0,00		1	D
355	10		40 045 355 17	0,00	0,00		1	D
400	10		40 045 400 17	0,00	0,00		1	D
450	10		40 045 450 17	0,00	0,00		1	D
500	10		40 045 500 17	0,00	0,00		1	D

40 048



**T-kus 90° redukovany PE100 SDR11**

na tupo, dlouhé konce

d x d mm	PN bar	m kg	objednáací kód	cena Kč	cena EUR	balení [ks]		sk
						MB	VB	
63 x 32	16		40 048 063 032 11	711,00	29,63			D
63 x 40	16		40 048 063 040 11	328,00	13,67			D
63 x 50	16		40 048 063 050 11	629,00	26,21			D
75 x 32	16		40 048 075 032 11	966,00	40,25			D
75 x 40	16		40 048 075 040 11	967,00	40,29			D
75 x 50	16		40 048 075 050 11	966,00	40,25			D
75 x 63	16		40 048 075 063 11	1 048,00	43,67			D
90 x 50	16		40 048 090 050 11	587,80	23,51			A
90 x 63	16		40 048 090 063 11	587,80	23,51			A
90 x 75	16		40 048 090 075 11	1 383,00	57,63			D
110 x 50	16		40 048 110 050 11	869,10	34,76			A
110 x 63	16		40 048 110 063 11	869,10	34,76			A
110 x 75	16		40 048 110 075 11	2 316,00	96,50			D
110 x 90	16		40 048 110 090 11	869,10	34,76			A
125 x 63	16		40 048 125 063 11	1 318,30	52,73			A
125 x 90	16		40 048 125 090 11	1 318,30	52,73			A
125 x 110	16		40 048 125 110 11	2 430,00	101,25			D
140 x 63	16		40 048 140 063 11	1 923,70	76,95			A
140 x 90	16		40 048 140 090 11	1 923,70	76,95			A
160 x 63	16		40 048 160 063 11	2 437,30	97,49			A
160 x 75	16		40 048 160 075 11	5 190,00	216,25			D
160 x 90	16		40 048 160 090 11	2 437,30	97,49			A
160 x 110	16		40 048 160 110 11	2 437,30	97,49			A
160 x 125	16		40 048 160 125 11	2 437,30	97,49			A



## PE100 Tvarovky na tupo

40 048

### T-kus 90° redukovaný PE100 SDR11

na tupo, dlouhé konce



d x d mm	PN bar	m kg	objednáací kód	cena Kč	cena EUR	balení [ks]		sk
						MB	VB	
180 x 63	16		40 048 180 063 111	3 275,20	131,01			A
180 x 90	16		40 048 180 090 111	3 275,20	131,01			A
180 x 110	16		40 048 180 110 111	3 275,20	131,01			A
180 x 125	16		40 048 180 125 111	3 275,20	131,01			A
180 x 160	16		40 048 180 160 111	7 284,00	303,50			D
200 x 63	16		40 048 200 063 111	4 833,70	193,35			A
200 x 90	16		40 048 200 090 111	4 833,70	193,35			A
200 x 110	16		40 048 200 110 111	4 833,70	193,35			A
200 x 125	16		40 048 200 125 111	4 833,70	193,35			A
200 x 160	16		40 048 200 160 111	4 833,70	193,35			A
200 x 180	16		40 048 200 180 111	4 833,70	193,35			A
225 x 75	16		40 048 225 075 111	12 469,00	519,54			D
225 x 90	16		40 048 225 090 111	5 818,00	232,72			A
225 x 110	16		40 048 225 110 111	10 685,00	445,21			D
225 x 125	16		40 048 225 125 111	5 818,00	232,72			A
225 x 160	16		40 048 225 160 111	5 818,00	232,72			A
225 x 180	16		40 048 225 180 111	5 818,00	232,72			A
250 x 110	16		40 048 250 110 111	9 497,40	379,90			A
250 x 125	16		40 048 250 125 111	9 497,40	379,90			A
250 x 160	16		40 048 250 160 111	9 497,40	379,90			A
250 x 180	16		40 048 250 180 111	9 497,40	379,90			A
250 x 200	16		40 048 250 200 111	9 497,40	379,90			A
280 x 110	16		40 048 280 110 111	12 581,20	503,25			A
280 x 225	16		40 048 280 225 111	12 581,20	503,25			A
315 x 110	16		40 048 315 110 111	15 122,10	604,88			A
315 x 125	16		40 048 315 125 111	15 122,10	604,88			A
315 x 160	16		40 048 315 160 111	15 122,10	604,88			A
315 x 180	16		40 048 315 180 111	15 122,10	604,88			A
315 x 200	16		40 048 315 200 111	15 122,10	604,88			A
315 x 225	16		40 048 315 225 111	15 122,10	604,88			A
315 x 250	16		40 048 315 250 111	23 750,00	989,58			D
355 x 110	16		40 048 355 110 111	29 199,30	1 167,97			A
355 x 160	16		40 048 355 160 111	29 199,30	1 167,97			A
355 x 225	16		40 048 355 225 111	29 199,30	1 167,97			A
400 x 110	16		40 048 400 110 111	40 641,90	1 625,68			A
400 x 160	16		40 048 400 160 111	40 641,90	1 625,68			A
400 x 225	16		40 048 400 225 111	40 641,90	1 625,68			A
450 x 160	16		40 048 450 160 111	53 344,30	2 133,77			A
450 x 225	16		40 048 450 225 111	53 344,30	2 133,77			A
450 x 315	16		40 048 450 315 111	53 344,30	2 133,77			A
500 x 160	16		40 048 500 160 111	73 663,30	2 946,53			A
500 x 250	16		40 048 500 250 111	73 663,30	2 946,53			A
500 x 315	16		40 048 500 315 111	73 663,30	2 946,53			A
560 x 250	16		40 048 560 250 111	96 521,20	3 860,85			A
630 x 160	16		40 048 630 160 111	132 083,30	5 283,33			A
630 x 250	16		40 048 630 250 111	132 083,30	5 283,33			A
630 x 315	16		40 048 630 315 111	132 083,30	5 283,33			A

40 048

T-kus 90° redukovaný PE100 SDR17

na tupo, dlouhé konce

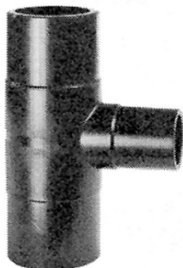

d x d mm	PN bar	m kg	objednáací kód	cena Kč	cena EUR	balení [ks]		sk
						MB	VB	
90 x 50	10		40 048 090 050 17I	539,00	21,56			A
90 x 63	10		40 048 090 063 17I	539,00	21,56			A
90 x 75	10		40 048 090 075 17	1 258,00	52,42			D
110 x 63	10		40 048 110 063 17I	792,90	31,72			A
110 x 75	10		40 048 110 075 17	2 024,00	84,33			D
110 x 90	10		40 048 110 090 17I	792,90	31,72			A
125 x 63	10		40 048 125 063 17I	1 199,20	47,97			A
125 x 90	10		40 048 125 090 17I	1 199,20	47,97			A
125 x 110	10		40 048 125 110 17	2 388,00	99,50			D
140 x 63	10		40 048 140 063 17I	1 751,80	70,07			A
140 x 90	10		40 048 140 090 17I	1 751,80	70,07			A
160 x 63	10		40 048 160 063 17I	2 220,60	88,82			A
160 x 75	10		40 048 160 075 17	4 809,00	200,38			D
160 x 90	10		40 048 160 090 17I	2 220,60	88,82			A
160 x 110	10		40 048 160 110 17I	2 220,60	88,82			A
160 x 125	10		40 048 160 125 17I	2 220,60	88,82			A
180 x 63	10		40 048 180 063 17I	2 980,30	119,21			A
180 x 90	10		40 048 180 090 17I	2 980,30	119,21			A
180 x 110	10		40 048 180 110 17I	2 980,30	119,21			A
180 x 125	10		40 048 180 125 17I	2 980,30	119,21			A
180 x 160	10		40 048 180 160 17	6 996,00	291,50			D
200 x 63	10		40 048 200 063 17I	4 398,20	175,93			A
200 x 90	10		40 048 200 090 17I	4 398,20	175,93			A
200 x 110	10		40 048 200 110 17I	4 398,20	175,93			A
200 x 125	10		40 048 200 125 17I	4 398,20	175,93			A
200 x 160	10		40 048 200 160 17I	4 398,20	175,93			A
225 x 75	10		40 048 225 075 17	11 834,00	493,08			D
225 x 90	10		40 048 225 090 17I	5 294,60	211,78			A
225 x 110	10		40 048 225 110 17	7 997,00	333,21			D
225 x 125	10		40 048 225 125 17I	5 294,60	211,78			A
225 x 160	10		40 048 225 160 17I	5 294,60	211,78			A
225 x 180	10		40 048 225 180 17I	5 294,60	211,78			A
250 x 110	10		40 048 250 110 17I	8 642,00	345,68			A
250 x 125	10		40 048 250 125 17I	8 642,00	345,68			A
250 x 160	10		40 048 250 160 17I	8 642,00	345,68			A
250 x 180	10		40 048 250 180 17I	8 642,00	345,68			A
250 x 200	10		40 048 250 200 17I	8 642,00	345,68			A
280 x 63	10		40 048 280 063 17	0,00	0,00			E
280 x 90	10		40 048 280 090 17	37 342,00	1 555,92			E
280 x 110	10		40 048 280 110 17I	11 430,90	457,24			A
280 x 225	10		40 048 280 225 17I	11 430,90	457,24			A
315 x 110	10		40 048 315 110 17I	13 745,20	549,81			A
315 x 125	10		40 048 315 125 17I	13 745,20	549,81			A
315 x 160	10		40 048 315 160 17I	13 745,20	549,81			A
315 x 180	10		40 048 315 180 17I	13 745,20	549,81			A
315 x 200	10		40 048 315 200 17I	13 745,20	549,81			A
315 x 225	10		40 048 315 225 17I	13 745,20	549,81			A
315 x 250	10		40 048 315 250 17	20 968,00	873,67			D
355 x 110	10		40 048 355 110 17I	21 959,50	878,38			A
355 x 160	10		40 048 355 160 17I	21 959,50	878,38			A
355 x 225	10		40 048 355 225 17I	21 959,50	878,38			A
355 x 250	10		40 048 355 250 17I	21 959,50	878,38			A
400 x 110	10		40 048 400 110 17I	33 661,90	1 346,48			A
400 x 160	10		40 048 400 160 17I	33 661,90	1 346,48			A
400 x 225	10		40 048 400 225 17I	33 661,90	1 346,48			A
450 x 160	10		40 048 450 160 17I	43 182,80	1 727,31			A
450 x 225	10		40 048 450 225 17I	43 182,80	1 727,31			A
450 x 315	10		40 048 450 315 17I	43 182,80	1 727,31			A

## PE100 Tvarovky na tupo

40 048



### T-kus 90° redukovaný PE100 SDR17

na tupo, dlouhé konce

d x d mm	PN bar	m kg	objednáací kód	cena Kč	cena EUR	balení [ks]		sk
						MB	VB	
500 x 160	10		40 048 500 160 171	59 943,40	2 397,74			A
500 x 250	10		40 048 500 250 171	59 943,40	2 397,74			A
500 x 315	10		40 048 500 315 171	59 943,40	2 397,74			A
560 x 250	10		40 048 560 250 171	73 663,30	2 946,53			A
630 x 160	10		40 048 630 160 171	101 600,90	4 064,04			A
630 x 250	10		40 048 630 250 171	101 600,90	4 064,04			A
630 x 315	10		40 048 630 315 171	101 600,90	4 064,04			A

40 052



### T-kus 45° PE100 SDR11, na tupo, dlouhé konce

d mm	PN bar	m kg	objednáací kód	cena Kč	cena EUR	balení [ks]		sk
						MB	VB	
63	16		40 052 063 111	523,40	20,94			A
75	16		40 052 075 111	835,90	33,44			A
90	16		40 052 090 111	1 019,50	40,78			A
110	16		40 052 110 111	1 515,50	60,62			A
125	16		40 052 125 111	2 558,40	102,34			A
140	16		40 052 140 111	3 786,90	151,48			A
160	16		40 052 160 111	4 855,20	194,21			A

40 052



### T-kus 45° PE100 SDR17, na tupo, dlouhé konce

d mm	PN bar	m kg	objednáací kód	cena Kč	cena EUR	balení [ks]		sk
						MB	VB	
63	10		40 052 063 171	468,70	18,75			A
75	10		40 052 075 171	783,10	31,32			A
90	10		40 052 090 171	912,10	36,48			A
110	10		40 052 110 171	1 384,70	55,39			A
125	10		40 052 125 171	2 324,10	92,96			A
140	10		40 052 140 171	3 396,30	135,85			A
160	10		40 052 160 171	4 415,70	176,63			A

40 200



### Y-kus PE100 SDR11, na tupo, dlouhé konce

d x d mm	PN bar	m kg	objednáací kód	cena Kč	cena EUR	balení [ks]		sk
						MB	VB	
40 x 32	16		40 200 040 0321	548,80	21,95			A

40 205



### kříž PE100 SDR11, na tupo, dlouhé konce

d mm	PN bar	m kg	objednáací kód	cena Kč	cena EUR	balení [ks]		sk
						MB	VB	
63	16		40 205 063 111	679,60	27,18			A
75	16		40 205 075 111	1 019,50	40,78			A
90	16		40 205 090 111	1 566,30	62,65			A
110	16		40 205 110 111	2 351,40	94,06			A
125	16		40 205 125 111	3 525,20	141,01			A
140	16		40 205 140 111	5 222,30	208,89			A
160	16		40 205 160 111	5 929,30	237,17			A
180	16		40 205 180 111	7 261,30	290,45			A
200	16		40 205 200 111	10 708,30	428,33			A
225	16		40 205 225 111	12 272,70	490,91			A
250	16		40 205 250 111	21 412,70	856,51			A
280	16		40 205 280 111	32 902,20	1 316,09			A
315	16		40 205 315 111	33 685,30	1 347,41			A
355	16		40 205 355 111	50 920,60	2 036,82			A

## PE100 Tvarovky na tupo

40 205



kříž PE100 SDR17, na tupo, dlouhé konce

d mm	PN bar	m kg	objednací kód	cena Kč	cena EUR	balení [ks]		sk
						MB	VB	
63	10		40 205 063 171	607,40	24,30			A
75	10		40 205 075 171	912,10	36,48			A
90	10		40 205 090 171	1 410,10	56,40			A
110	10		40 205 110 171	2 117,10	84,68			A
125	10		40 205 125 171	3 185,30	127,41			A
140	10		40 205 140 171	4 700,90	188,04			A
160	10		40 205 160 171	5 378,60	215,14			A
180	10		40 205 180 171	6 554,30	262,17			A
200	10		40 205 200 171	9 737,70	389,51			A
225	10		40 205 225 171	11 753,20	470,13			A
250	10		40 205 250 171	19 192,10	767,68			A
280	10		40 205 280 171	29 767,60	1 190,70			A
315	10		40 205 315 171	30 812,50	1 232,50			A
355	10		40 205 355 171	41 780,50	1 671,22			A

# PE100 Tvarovky na tupo

40 064



redukce PE100 SDR11, na tupo, dlouhé konce

d x d mm	PN bar	m kg	objednáací kód	cena Kč	cena EUR	balení [ks]		sk
						MB	VB	
25 x 20	16		40 064 025 020 11	106,00	4,42		40	D
32 x 20	16		40 064 032 020 11	103,00	4,29		100	D
32 x 25	16		40 064 032 025 11	88,00	3,67		45	D
40 x 20	16		40 064 040 020 111	128,90	5,16			A
40 x 25	16		40 064 040 025 111	128,90	5,16			A
40 x 32	16		40 064 040 032 111	128,90	5,16			A
50 x 20	16		40 064 050 020 11	182,00	7,58		20	D
50 x 25	16		40 064 050 025 111	128,90	5,16			A
50 x 32	16		40 064 050 032 111	128,90	5,16			A
50 x 40	16		40 064 050 040 111	128,90	5,16			A
63 x 25	16		40 064 063 025 111	144,50	5,78			A
63 x 32	16		40 064 063 032 111	144,50	5,78			A
63 x 40	16		40 064 063 040 111	144,50	5,78			A
63 x 50	16		40 064 063 050 111	144,50	5,78			A
75 x 32	16		40 064 075 032 111	177,70	7,11			A
75 x 40	16		40 064 075 040 111	177,70	7,11			A
75 x 50	16		40 064 075 050 111	177,70	7,11			A
75 x 63	16		40 064 075 063 111	177,70	7,11			A
90 x 50	16		40 064 090 050 111	238,30	9,53			A
90 x 63	16		40 064 090 063 111	238,30	9,53			A
90 x 75	16		40 064 090 075 111	238,30	9,53			A
110 x 50	16		40 064 110 050 111	316,40	12,66			A
110 x 63	16		40 064 110 063 111	316,40	12,66			A
110 x 75	16		40 064 110 075 111	316,40	12,66			A
110 x 90	16		40 064 110 090 111	316,40	12,66			A
125 x 63	16		40 064 125 063 111	445,30	17,81			A
125 x 75	16		40 064 125 075 111	445,30	17,81			A
125 x 90	16		40 064 125 090 111	445,30	17,81			A
125 x 110	16		40 064 125 110 111	445,30	17,81			A
140 x 75	16		40 064 140 075 11	1 260,00	52,50		14	D
140 x 90	16		40 064 140 090 111	691,40	27,66			A
140 x 110	16		40 064 140 110 111	691,40	27,66			A
140 x 125	16		40 064 140 125 111	691,40	27,66			A
160 x 90	16		40 064 160 090 111	841,70	33,67			A
160 x 110	16		40 064 160 110 111	841,70	33,67			A
160 x 125	16		40 064 160 125 111	841,70	33,67			A
160 x 140	16		40 064 160 140 111	841,70	33,67			A
180 x 63	16		40 064 180 063 111	964,80	38,59			A
180 x 90	16		40 064 180 090 11	1 885,00	78,54		8	D
180 x 110	16		40 064 180 110 111	964,80	38,59			A
180 x 125	16		40 064 180 125 111	964,80	38,59			A
180 x 140	16		40 064 180 140 111	964,80	38,59			A
180 x 160	16		40 064 180 160 111	964,80	38,59			A
200 x 90	16		40 064 200 090 111	1 267,50	50,70			A
200 x 140	16		40 064 200 140 111	1 267,50	50,70			A
200 x 160	16		40 064 200 160 111	1 267,50	50,70			A
200 x 180	16		40 064 200 180 111	1 267,50	50,70			A
225 x 110	16		40 064 225 110 111	1 728,40	69,14			A
225 x 140	16		40 064 225 140 11	3 790,00	157,92		4	D
225 x 160	16		40 064 225 160 111	1 728,40	69,14			A
225 x 180	16		40 064 225 180 111	1 728,40	69,14			A
225 x 200	16		40 064 225 200 111	1 728,40	69,14			A
250 x 160	16		40 064 250 160 11	5 375,00	223,96		7	D
250 x 180	16		40 064 250 180 111	2 456,90	98,28			A
250 x 200	16		40 064 250 200 111	2 456,90	98,28			A
250 x 225	16		40 064 250 225 111	2 456,90	98,28			A
280 x 200	16		40 064 280 200 11	7 349,00	306,21		5	D
280 x 225	16		40 064 280 225 11	7 409,00	308,71		5	D
280 x 250	16		40 064 280 250 11	6 675,00	278,13		4	D
315 x 200	16		40 064 315 200 11	0,00	0,00			D

## PE100 Tvarovky na tupo

40 064



redukce PE100 SDR11, na tupo, dlouhé konce

d x d mm	PN bar	m kg	objednáací kód	cena Kč	cena EUR	balení [ks]		sk
						MB	VB	
315 x 200	16		40 064 315 200 11	0,00	0,00			D
315 x 225	16		40 064 315 225 11	4 034,90	161,40			A
315 x 250	16		40 064 315 250 11	4 034,90	161,40			A
315 x 280	16		40 064 315 280 11	9 719,00	404,96		2	D
355 x 250	16		40 064 355 250 11	34 787,00	1 449,46		2	D
355 x 280	16		40 064 355 280 11	32 052,00	1 335,50		2	D
355 x 315	16		40 064 355 315 11	30 622,00	1 275,92		2	D
400 x 280	16		40 064 400 280 11	50 639,00	2 109,96		2	D
400 x 315	16		40 064 400 315 11	47 519,00	1 979,96		2	D
400 x 355	16		40 064 400 355 11	46 146,00	1 922,75		2	D

40 065



redukce PE100 SDR11, na tupo, krátké konce

d x d mm	PN bar	m kg	objednáací kód	cena Kč	cena EUR	balení [ks]		sk
						MB	VB	
250 x 160	16		40 065 250 160 11	1 747,90	69,92			A
250 x 180	16		40 065 250 180 11	1 747,90	69,92			A
250 x 200	16		40 065 250 200 11	1 747,90	69,92			A
250 x 225	16		40 065 250 225 11	1 747,90	69,92			A
280 x 200	16		40 065 280 200 11	2 093,60	83,74			A
280 x 225	16		40 065 280 225 11	2 093,60	83,74			A
280 x 250	16		40 065 280 250 11	2 093,60	83,74			A
315 x 200	16		40 065 315 200 11	0,00	0,00			D
315 x 225	16		40 065 315 225 11	2 218,60	88,74			A
315 x 250	16		40 065 315 250 11	2 218,60	88,74			A
315 x 280	16		40 065 315 280 11	2 218,60	88,74			A
355 x 225	16		40 065 355 225 11	2 714,70	108,59			A
355 x 250	16		40 065 355 250 11	2 714,70	108,59			A
355 x 280	16		40 065 355 280 11	2 714,70	108,59			A
355 x 315	16		40 065 355 315 11	2 714,70	108,59			A
400 x 225	16		40 065 400 225 11	0,00	0,00			D
400 x 250	16		40 065 400 250 11	0,00	0,00			D
400 x 280	16		40 065 400 280 11	5 183,30	207,33			A
400 x 315	16		40 065 400 315 11	5 183,30	207,33			A
400 x 355	16		40 065 400 355 11	5 183,30	207,33			A
450 x 280	16		40 065 450 280 11	0,00	0,00			D
450 x 315	16		40 065 450 315 11	8 226,00	329,04			A
450 x 355	16		40 065 450 355 11	8 226,00	329,04			A
450 x 400	16		40 065 450 400 11	8 226,00	329,04			A
500 x 315	16		40 065 500 315 11	0,00	0,00			D
500 x 355	16		40 065 500 355 11	12 163,30	486,53			A
500 x 400	16		40 065 500 400 11	12 163,30	486,53			A
500 x 450	16		40 065 500 450 11	12 163,30	486,53			A
560 x 400	16		40 065 560 400 11	15 715,80	628,63			A
560 x 450	16		40 065 560 450 11	15 715,80	628,63			A
560 x 500	16		40 065 560 500 11	15 715,80	628,63			A
630 x 450	16		40 065 630 450 11	19 444,10	777,76			A
630 x 500	16		40 065 630 500 11	19 444,10	777,76			A
630 x 560	16		40 065 630 560 11	19 444,10	777,76			A

# PE100 Tvarovky na tupo

40 064



redukce PE100 SDR17, na tupo, dlouhé konce

d x d mm	PN bar	m kg	objednáací kód	cena Kč	cena EUR	balení [ks]		sk
						MB	VB	
90 x 63	10		40 064 090 063 17	431,00	17,96			D
90 x 75	10		40 064 090 075 17	522,00	21,75			D
110 x 50	10		40 064 110 050 17I	294,90	11,80			A
110 x 63	10		40 064 110 063 17I	294,90	11,80			A
110 x 75	10		40 064 110 075 17I	294,90	11,80			A
110 x 90	10		40 064 110 090 17I	294,90	11,80			A
125 x 63	10		40 064 125 063 17I	418,00	16,72			A
125 x 75	10		40 064 125 075 17I	418,00	16,72			A
125 x 90	10		40 064 125 090 17I	418,00	16,72			A
125 x 110	10		40 064 125 110 17I	418,00	16,72			A
140 x 75	10		40 064 140 075 17	1 246,00	51,92			D
140 x 90	10		40 064 140 090 17I	650,30	26,01			A
140 x 110	10		40 064 140 110 17I	650,30	26,01			A
140 x 125	10		40 064 140 125 17I	650,30	26,01			A
160 x 90	10		40 064 160 090 17I	785,10	31,40			A
160 x 110	10		40 064 160 110 17I	785,10	31,40			A
160 x 125	10		40 064 160 125 17I	785,10	31,40			A
160 x 140	10		40 064 160 140 17I	785,10	31,40			A
180 x 63	10		40 064 180 063 17I	906,20	36,25			A
180 x 90	10		40 064 180 090 17	1 867,00	77,79		8	D
180 x 110	10		40 064 180 110 17I	906,20	36,25			A
180 x 125	10		40 064 180 125 17I	906,20	36,25			A
180 x 140	10		40 064 180 140 17I	906,20	36,25			A
180 x 160	10		40 064 180 160 17I	906,20	36,25			A
200 x 90	10		40 064 200 090 17I	1 187,40	47,50			A
200 x 140	10		40 064 200 140 17I	1 187,40	47,50			A
200 x 160	10		40 064 200 160 17I	1 187,40	47,50			A
200 x 180	10		40 064 200 180 17I	1 187,40	47,50			A
225 x 110	10		40 064 225 110 17I	1 615,10	64,60			A
225 x 140	10		40 064 225 140 17	3 826,00	159,42		4	D
225 x 160	10		40 064 225 160 17I	1 615,10	64,60			A
225 x 180	10		40 064 225 180 17I	1 615,10	64,60			A
225 x 200	10		40 064 225 200 17I	1 615,10	64,60			A
250 x 160	10		40 064 250 160 17	5 248,00	218,67		7	D
250 x 180	10		40 064 250 180 17I	2 167,80	86,71			A
250 x 200	10		40 064 250 200 17I	2 167,80	86,71			A
250 x 225	10		40 064 250 225 17I	2 167,80	86,71			A
280 x 200	10		40 064 280 200 17	7 349,00	306,21		5	D
280 x 225	10		40 064 280 225 17	7 409,00	308,71		5	D
280 x 250	10		40 064 280 250 17	6 021,00	250,88		4	D
315 x 200	10		40 064 315 200 17	0,00	0,00			D
315 x 225	10		40 064 315 225 17I	3 554,50	142,18			A
315 x 250	10		40 064 315 250 17I	3 554,50	142,18			A
315 x 280	10		40 064 315 280 17	9 639,00	401,63		2	D
355 x 250	10		40 064 355 250 17	31 397,00	1 308,21		2	D
355 x 280	10		40 064 355 280 17	29 121,00	1 213,38		2	D
355 x 315	10		40 064 355 315 17	29 234,00	1 218,08		2	D
400 x 280	10		40 064 400 280 17	46 798,00	1 949,92		2	D
400 x 315	10		40 064 400 315 17	37 756,00	1 573,17		2	D
400 x 355	10		40 064 400 355 17	41 076,00	1 711,50		2	D
450 x 280	10		40 064 450 280 17	75 558,00	3 148,25			D
450 x 315	10		40 064 450 315 17	68 398,00	2 849,92			D
450 x 355	10		40 064 450 355 17	59 160,00	2 465,00			D
450 x 400	10		40 064 450 400 17	54 520,00	2 271,67			D
500 x 315	10		40 064 500 315 17	94 838,00	3 951,58			D
500 x 355	10		40 064 500 355 17	88 638,00	3 693,25			D
500 x 400	10		40 064 500 400 17	74 878,00	3 119,92			D
500 x 450	10		40 064 500 450 17	70 358,00	2 931,58			D

## PE100 Tvarovky na tupo

40 064



redukce PE100 SDR17, na tupo, dlouhé konce

d x d mm	PN bar	m kg	objednáací kód	cena Kč	cena EUR	balení [ks]		sk
						MB	VB	
560 x 355	10		40 064 560 355 17	---	---			-
560 x 400	10		40 064 560 400 17	---	---			-
560 x 450	10		40 064 560 450 17	---	---			-
560 x 500	10		40 064 560 500 17	---	---			-
630 x 400	10		40 064 630 400 17	---	---			-
630 x 450	10		40 064 630 450 17	---	---			-
630 x 500	10		40 064 630 500 17	---	---			-
630 x 560	10		40 064 630 560 17	---	---			-

40 065



redukce PE100 SDR17, na tupo, krátké konce

d x d mm	PN bar	m kg	objednáací kód	cena Kč	cena EUR	balení [ks]		sk
						MB	VB	
250 x 160	10		40 065 250 160 17I	1 498,00	59,92			A
250 x 180	10		40 065 250 180 17I	1 498,00	59,92			A
250 x 200	10		40 065 250 200 17I	1 498,00	59,92			A
250 x 225	10		40 065 250 225 17I	1 498,00	59,92			A
280 x 200	10		40 065 280 200 17I	1 747,90	69,92			A
280 x 225	10		40 065 280 225 17I	1 747,90	69,92			A
280 x 250	10		40 065 280 250 17I	1 747,90	69,92			A
315 x 200	10		40 065 315 200 17	0,00	0,00			D
315 x 225	10		40 065 315 225 17I	1 845,60	73,82			A
315 x 250	10		40 065 315 250 17I	1 845,60	73,82			A
315 x 280	10		40 065 315 280 17I	1 845,60	73,82			A
355 x 225	10		40 065 355 225 17I	2 244,00	89,76			A
355 x 250	10		40 065 355 250 17I	2 244,00	89,76			A
355 x 280	10		40 065 355 280 17I	2 244,00	89,76			A
355 x 315	10		40 065 355 315 17I	2 244,00	89,76			A
400 x 280	10		40 065 400 280 17I	4 113,00	164,52			A
400 x 315	10		40 065 400 315 17I	4 113,00	164,52			A
400 x 355	10		40 065 400 355 17I	4 113,00	164,52			A
450 x 315	10		40 065 450 315 17I	6 505,40	260,22			A
450 x 355	10		40 065 450 355 17I	6 505,40	260,22			A
450 x 400	10		40 065 450 400 17I	6 505,40	260,22			A
500 x 355	10		40 065 500 355 17I	10 208,30	408,33			A
500 x 400	10		40 065 500 400 17I	10 208,30	408,33			A
500 x 450	10		40 065 500 450 17I	10 208,30	408,33			A
560 x 400	10		40 065 560 400 17I	11 716,10	468,64			A
560 x 450	10		40 065 560 450 17I	11 716,10	468,64			A
560 x 500	10		40 065 560 500 17I	11 716,10	468,64			A
630 x 450	10		40 065 630 450 17I	15 456,10	618,24			A
630 x 500	10		40 065 630 500 17I	15 456,10	618,24			A
630 x 560	10		40 065 630 560 17I	15 456,10	618,24			A



## PE100 Tvarovky na tupo

40 107

**víčko PE100 SDR11, na tupo, dlouhé**



d mm	PN bar	m kg	objednáací kód	cena Kč	cena EUR	balení [ks]		sk
						MB	VB	
20	16		40 107 020 111	91,80	3,67			A
25	16		40 107 025 111	91,80	3,67			A
32	16		40 107 032 111	123,00	4,92			A
40	16		40 107 040 111	140,60	5,62			A
50	16		40 107 050 111	169,90	6,80			A
63	16		40 107 063 111	195,30	7,81			A
75	16		40 107 075 111	226,50	9,06			A
90	16		40 107 090 111	277,30	11,09			A
110	16		40 107 110 111	418,00	16,72			A
125	16		40 107 125 111	468,70	18,75			A
140	16		40 107 140 111	763,60	30,54			A
160	16		40 107 160 111	783,10	31,32			A
180	16		40 107 180 111	941,40	37,66			A
200	16		40 107 200 111	1 535,10	61,40			A
225	16		40 107 225 111	1 904,20	76,17			A
250	16		40 107 250 111	2 062,40	82,50			A
280	16		40 107 280 111	2 636,60	105,46			A
315	16		40 107 315 111	4 700,90	188,04			A

40 108

**víčko PE100 SDR11, na tupo, krátké**



d mm	PN bar	m kg	objednáací kód	cena Kč	cena EUR	balení [ks]		sk
						MB	VB	
355	16		40 108 355 111	7 478,00	299,12			A
400	16		40 108 400 111	10 921,20	436,85			A
450	16		40 108 450 111	15 668,90	626,76			A
500	16		40 108 500 111	17 803,50	712,14			A
560	16		40 108 560 111	24 926,10	997,04			A
630	16		40 108 630 111	34 419,70	1 376,79			A

40 107

**víčko PE100 SDR17, na tupo, dlouhé**



d mm	PN bar	m kg	objednáací kód	cena Kč	cena EUR	balení [ks]		sk
						MB	VB	
63	10		40 107 063 171	179,70	7,19			A
75	10		40 107 075 171	209,00	8,36			A
90	10		40 107 090 171	234,50	9,38			B
110	10		40 107 110 171	384,70	15,39			A
125	10		40 107 125 171	433,60	17,34			A
140	10		40 107 140 171	703,10	28,12			A
160	10		40 107 160 171	720,70	28,83			A
180	10		40 107 180 171	865,20	34,61			A
200	10		40 107 200 171	1 410,10	56,40			A
225	10		40 107 225 171	1 751,80	70,07			A
250	10		40 107 250 171	1 904,20	76,17			A
280	10		40 107 280 171	2 421,70	96,87			A
315	10		40 107 315 171	4 320,00	172,80			A

40 108

**víčko PE100 SDR17, na tupo, krátké**



d mm	PN bar	m kg	objednáací kód	cena Kč	cena EUR	balení [ks]		sk
						MB	VB	
355	16		40 108 355 171	5 460,60	218,42			A
400	16		40 108 400 171	8 310,00	332,40			A
450	16		40 108 450 171	10 681,00	427,24			A
500	16		40 108 500 171	14 006,90	560,28			A
560	16		40 108 560 171	17 803,50	712,14			A
630	16		40 108 630 171	29 673,90	1 186,96			A

40 150

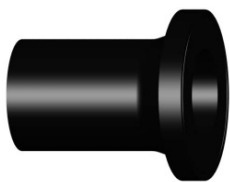

**PE100 SDR11 lemový nákrůžek na tupo, dlouhý**

d mm	PN bar	m kg	objednáací kód	cena Kč	cena EUR	balení [ks]		sk
						MB	VB	
d20	16		40 150 020 111	111,00	4,44			B
d25	16		40 150 025 111	111,00	4,44			B
d32	16		40 150 032 111	111,00	4,44			B
d40	16		40 150 040 111	130,90	5,24			A
d50	16		40 150 050 111	140,60	5,62			A
d63	16		40 150 063 111	154,30	6,17			A
d75	16		40 150 075 111	189,40	7,58			A
d90	16		40 150 090 111	250,00	10,00			A
d110	16		40 150 110 111	343,70	13,75			A
d125	16		40 150 125 111	357,40	14,30			A
d140	16		40 150 140 111	453,10	18,12			A
d160	16		40 150 160 111	582,00	23,28			A
d180	16		40 150 180 111	929,60	37,18			A
d200	16		40 150 200 111	1 080,00	43,20			A
d225	16		40 150 225 111	1 164,00	46,56			A
d250	16		40 150 250 111	1 779,20	71,17			A
d280	16		40 150 280 111	2 613,10	104,52			A
d315	16		40 150 315 111	3 064,30	122,57			A
d355	16		40 150 355 111	5 818,00	232,72			A
d400	16		40 150 400 111	10 327,50	413,10			A
d450	16		40 150 450 11	23 044,00	960,167			D
d500	16		40 150 500 11	24 366,00	1015,25			D
d560	16		40 150 560 11	0,00	0,00			D
d630	16		40 150 630 11	0,00	0,00			D

40 151



**PE100 SDR11 lemový nákrůžek na tupo, krátký**

d mm	PN bar	m kg	objednáací kód	cena Kč	cena EUR	balení [ks]		sk
						MB	VB	
d250	16		40 151 250 111	1 419,80	56,79			A
d280	16		40 151 280 111	1 722,60	68,90			A
d315	16		40 151 315 111	2 249,90	90,00			A
d355	16		40 151 355 111	3 076,00	123,04			A
d400	16		40 151 400 111	5 839,50	233,58			A
d450	16		40 151 450 111	9 259,20	370,368			A
d500	16		40 151 500 111	9 399,80	375,992			A
d560	16		40 151 560 111	12 012,90	480,516			A
d630	16		40 151 630 111	13 577,30	543,09			A

40 150



**PE100 SDR17 lemový nákrůžek na tupo, dlouhý**

d mm	PN bar	m kg	objednáací kód	cena Kč	cena EUR	balení [ks]		sk
						MB	VB	
63	10		40 150 063 171	115,70	4,63			C
75	10		40 150 075 171	147,10	5,88			C
90	10		40 150 090 171	228,50	9,14			A
110	10		40 150 110 171	298,80	11,95			A
125	10		40 150 125 171	332,00	13,28			A
140	10		40 150 140 171	437,50	17,50			A
160	10		40 150 160 171	523,40	20,94			A
180	10		40 150 180 171	855,40	34,22			A
200	10		40 150 200 171	1 019,50	40,78			A
225	10		40 150 225 171	1 091,70	43,67			A
250	10		40 150 250 171	1 665,90	66,64			A
280	10		40 150 280 171	2 421,70	96,87			A
315	10		40 150 315 171	2 730,30	109,21			A
355	10		40 150 355 171	4 677,40	187,10			A
400	10		40 150 400 171	9 544,30	381,77			A
450	10		40 150 450 17	20 722,00	863,417			D
500	10		40 150 500 17	21 483,00	895,125			D
560	10		40 150 560 17	0,00	0,00			D
630	10		40 150 630 17	0,00	0,00			D

## PE100 Tvarovky na tupo

40 151



### PE100 SDR17 lemový nákržek na tupo, krátký

d mm	PN bar	m kg	objednáací kód	cena Kč	cena EUR	balení [ks]		sk
						MB	VB	
d250	10		40 151 250 171	1 310,50	52,42			A
d280	10		40 151 280 171	1 498,00	59,92			A
d315	10		40 151 315 171	1 779,20	71,17			A
d355	10		40 151 355 171	2 681,50	107,26			A
d400	10		40 151 400 171	4 464,60	178,58			A
d450	10		40 151 450 171	7 052,30	282,092			A
d500	10		40 151 500 171	7 312,00	292,48			A
d560	10		40 151 560 171	10 184,90	407,396			A
d630	10		40 151 630 171	11 620,40	464,816			A

40 160



### PP-V otočná příruba

PP plněný skelným vláknem (30%), tlaková třída PN16, rozteč šroubů PN10/PN16

d/DN mm	PN bar	m kg	objednáací kód	cena Kč	cena EUR	balení [ks]		sk
						MB	VB	
d20/DN15	16		40 160 020	202,40	8,43			D
d25/DN20	16		40 160 025	227,90	9,50			D
d32/DN25	16		40 160 032	291,80	12,16			D
d40/DN32	16		40 160 040	343,80	14,33			D
d50/DN40	16		40 160 050	408,60	17,03			D
d63/DN50	16		40 160 063	512,80	21,37			D
d75/DN65	16		40 160 075	573,70	23,90			D
d90/DN80	16		40 160 090	683,70	28,49			D
d110/DN100	16		40 160 110	841,90	35,08			D

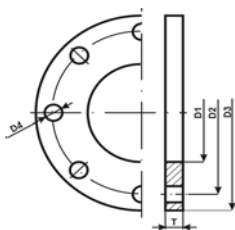

d/DN mm	D1 mm	D2 mm	D3 mm	počet děr	D4 mm	T mm
20/15	28	65	95	4	14	16
25/20	34	75	105	4	14	17
32/25	42	85	115	4	14	18
40/32	51	100	140	4	18	20
50/40	62	110	150	4	18	22
63/50	78	125	165	4	18	24
75/65	92	145	185	4	18	26
90/80	108	160	200	8	18	27
110/100	128	180	220	8	18	28

40 161



### PP otočná příruba s ocelovou vložkou

rozteč šroubů PN16

d/DN mm	PN bar	m kg	objednáací kód	cena Kč	cena EUR	balení [ks]		sk
						MB	VB	
d20/DN15	16		40 161 020	226,00	9,42			D
d25/DN20	16		40 161 025	273,00	11,38			D
d32/DN25	16		40 161 032	344,00	14,33			D
d40/DN32	16		40 161 040	385,00	16,04			D
d50/DN40	16		40 161 050C	462,00	18,48			C
d63/DN50	16		40 161 063C	486,20	19,45			C
d75/DN65	16		40 161 075C	547,10	21,88			C
d90/DN80	16		40 161 090C	737,80	29,51			A
d110/DN100	16		40 161 110C	786,30	31,45			A
d125/DN100	16		40 161 125C	795,80	31,83			A
d140/DN125	16		40 161 140C	963,30	38,53			A
d160/DN150	16		40 161 160C	1 482,90	59,32			A
d180/DN150	16		40 161 180	1 564,00	65,17			D
d200/DN200	16		40 161 200 16	2 844,00	118,50			D
d225/DN200	16		40 161 225 16	2 844,00	118,50			D
d250/DN250	16		40 161 250 16C	2 898,80	115,95			A
d280/DN250	16		40 161 280 16	3 455,00	143,96			D
d315/DN300	16		40 161 315 16	5 283,00	220,13			D
d355/DN350	16		40 161 355 16	9 996,00	416,50			D
d400/DN400	16		40 161 400 16	11 378,00	474,08			D

## PE100 Tvarovky na tupo

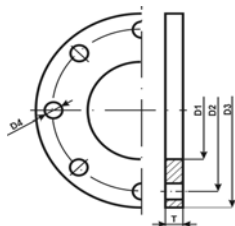

d/DN mm	D1 mm	D2 mm	D3 mm	počet děr	D4 mm	T mm
d20/DN15	30	65	96	4	14	12
d25/DN20	36	75	108	4	14	14
d32/DN25	42	85	114	4	14	15
d40/DN32	51	100	139	4	18	17
d50/DN40	62	110	150	4	18	18
d63/DN50	78	125	165	4	18	18
d75/DN65	92	145	185	4	18	18
d90/DN80	108	160	200	8	18	18
d110/DN100	128	180	220	8	18	18
d125/DN100	135	180	220	8	18	18
d140/DN125	158	210	250	8	18	24
d160/DN150	178	240	285	8	22	24
d180/DN150	189	240	285	8	22	24
d200/DN200	235	295	340	12	22	26
d225/DN200	238	295	340	12	22	26
d250/DN250	289	355	404	12	22	32
d280/DN250	294	355	404	12	22	32
d315/DN300	339	410	474	12	22	34
d355/DN350	377	471	530	16	26	50
d400/DN400	430	526	590	16	30	54

## 40 161

### PP otočná příruba s ocelovou vložkou

rozteč šroubů PN10



d/DN mm	PN bar	m kg	objednáací kód	cena Kč	cena EUR	balení [ks] MB VB	sk
d200/DN200	10		40 161 200 10C	1 861,30	74,45		A
d225/DN200	10		40 161 225 10C	1 861,30	74,45		A
d250/DN250	10		40 161 250 10C	2 601,10	104,04		A
d280/DN250	10		40 161 280 10C	2 659,30	106,37		A
d315/DN300	10		40 161 315 10C	3 678,30	147,13		A
d355/DN350	10		40 161 355 10	8 316,00	346,50		D
d400/DN400	10		40 161 400 10	9 463,00	394,29		D
d450/DN500	10		40 161 450 10	15 154,00	631,42		D
d500/DN500	10		40 161 500 10	15 154,00	631,42		D
d560/DN600	10		40 161 560 10C	23 305,30	932,21		A
d630/DN600	10		40 161 630 10C	23 305,30	932,21		A

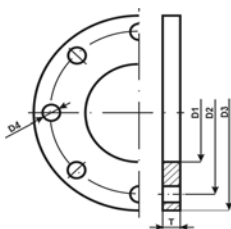

d/DN mm	D1 mm	D2 mm	D3 mm	počet děr	D4 mm	T mm
d200/DN200	236	295	340	8	22	24
d225/DN200	238	295	340	8	22	24
d250/DN250	289	350	395	12	22	30
d280/DN250	294	350	395	12	22	30
d315/DN300	339	400	460	12	22	34
d355/DN350	376	461	512	16	22	50
d400/DN400	430	516	570	16	26	54
d450/DN500	520	621	675	20	26	45
d500/DN500	535	621	675	20	26	46
d560/DN600	620	725	780	20	30	50
d630/DN600	645	725	780	20	30	50

35 002

## EPDM profilované gumokovové těsnění



d/DN mm	PN bar	m kg	objednací kód	cena Kč	cena EUR	balení [ks]		sk
						MB	VB	
d32/DN25 PN10-16	16		35 002 032	238,00	9,92			C
d40/DN32 PN10-16	16		35 002 040	245,00	10,21			C
d50/DN40 PN10-16	16		35 002 050	246,00	10,25			C
d63/DN50 PN10-16	16		35 002 063	266,00	11,08			C
d75/DN65 PN10-16	16		35 002 075	285,00	11,88			C
d90/DN80 PN10-16	16		35 002 090	298,00	12,42			C
d110/DN100 PN10-16	16		35 002 110	314,00	13,08			C
d1125/DN100 PN10-16	16		35 002 125 100	420,00	17,50			C
d140/DN125 PN10-16	16		35 002 140	348,00	14,50			C
d160-d180/DN150 PN10-16	16		35 002 160	432,00	18,00			C
d200-d225/DN200 PN10-16	16		35 002 200	597,00	24,88			C
d250-d280/DN250 PN10-16	16		35 002 250	757,00	31,54			C
d315/DN300 PN10	16		35 002 315 10	848,00	35,33			C
d355/DN350 PN10	16		35 002 355 10	968,00	40,33			C
d400/DN400 PN10	16		35 002 400 10	1 177,00	49,04			C
d450-d500/DN500 PN10	16		35 002 450 10	---	---			-
d560-d630/DN600 PN10	16		35 002 560 10	---	---			-

### technické informace

#### PP svěrné tvarovky

##### použití

Polypropylenové svěrné tvarovky jsou určeny pro rychlé a bezpečné spojování všech typů polyetylenových trubek (LDPE, MDPE, HDPE80, HDPE100) a PEX-a bez nutnosti demontáže tvarovky. Zaručují dokonale těsné spojení a dlouhou životnost při nízkých pořizovacích nákladech. Jsou schváleny pro pitnou vodu a odolné vůči UV záření.

##### vlastnosti

- rozsah vyráběných průměrů: d16 – d110
- umožňují opakovanou montáž, spojování trubek o nestejně tloušťce stěny a okamžité uvedení systému do provozu
- díky těsnicímu kroužku s lichoběžníkovým profilem dokonale těsní i při použití mírně oválných nebo poškrábaných trubek
- materiály: tělo, matice a přitlačný kroužek: UV stabilizovaný polypropylenový kopolymer PP-B  
svěrný kroužek: POM  
těsnící kroužek: NBR d16 – d63: 70 Shore, d75 – d110: 60 Shore  
zpevňující kroužek: nerezová ocel AISI 430
- barva: tělo černé, matice modré

#### PP navrtávací objímky

##### použití

Polypropylenové navrtávací objímky jsou určeny pro rychlé vytváření odboček bez nutnosti vkládat odbočnou tvarovku do potrubí. Jsou schváleny pro pitnou vodu a odolné proti UV záření.

##### vlastnosti

- rozsah vyráběných rozměrů: d20 – d315 / ½“ – 4“
- umožňují opakovanou montáž a okamžité uvedení systému do provozu
- materiály: tělo: UV stabilizovaný polypropylenový kopolymer PP-B  
těsnění: NBR 70 Shore  
zpevňující kroužek: nerezová ocel AISI 430  
šrouby a matice: galvanicky pozinkované nebo nerezové
- barva: tělo: černá  
tělo typ 654, 655: šedá

**rozsah pracovních teplot: -10°C až 45°C**

**maximální pracovní tlak v závislosti na teplotě (bar)**

teplota	-10°C - +25°C	35°C	45°C
PN16	16	12,5	10
PN12,5	12,5	10	8
PN10	10	8	6
PN6	6	4,5	-

### montážní návod svěrné tvarovky

1. Uřízněte trubku kolmo k ose a vytvořte náběh na vnější hraně. Těsnění tvarovky je namazané z výroby tukem. Pokud je těsnění suché (např. při opakované montáži), namažte je vhodným tukem, např. silikonovou vazelínou nebo silikonovým olejem. Pro snadnější montáž můžete potřít tukem také konec trubky. Povolte matici tvarovky, nedemontujte matici úplně.
2. Na trubku si označte hloubku zasunutí, pro optickou kontrolu správné montáže. Nasadte tvarovku na trubku přes svěrný kroužek až do prvního odporu, to znamená, že trubka dosáhla těsnění.
3. Zasuňte trubku přes těsnění, dokud nedosáhnete zářezky ve tvarovce.
4. Utáhněte matici. Matice tvarovek do d32 včetně dotahujeme obvykle rukou bez použití nástroje. Matice tvarovek d40 a větší dotahujeme vhodným nástrojem. Pro dotahování matic používejte kurtový hasák nebo speciální klíče k tomu určené.

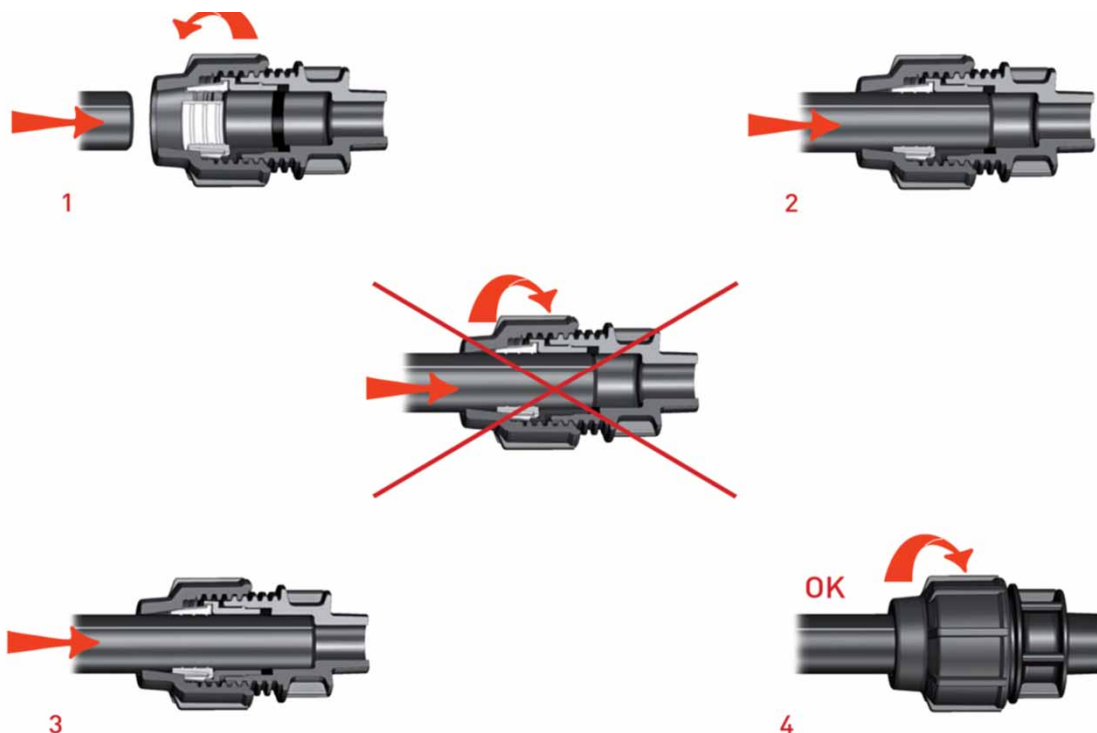

### montážní návod navrtávací objímky



## PP svěrné tvarovky

40 991

koleno 90°



d mm	PN bar	m kg	objednáací kód	cena Kč	cena EUR	balení [ks]		sk
						MB	VB	
16	16	0,084	40 991 016	31,00	1,24	25	150	R
20	16		40 991 020S	54,30	2,17	25	150	R
25	16		40 991 025S	66,00	2,64	10	100	R
32	16		40 991 032S	81,00	3,24	10	60	R
40	16		40 991 040S	150,20	6,01		45	R
50	16		40 991 050S	211,20	8,45		20	R
63	16		40 991 063S	255,40	10,22		12	R
75	10		40 991 075S	522,50	20,90		6	R
90	10		40 991 090S	648,50	25,94		3	R
110	10		40 991 110S	1 343,00	53,72		6	R

40 903

koleno 90° svěrný spoj x vnější závit



d x R mm x inch	PN bar	m kg	objednáací kód	cena Kč	cena EUR	balení [ks]		sk
						MB	VB	
16 x 1/2"	16	0,029	40 903 016 012A	37,50	1,50	20	400	S
16 x 3/4"	16	0,056	40 903 016 034	25,00	1,00	25	200	R
20 x 1/2"	16		40 903 020 012S	35,90	1,44	25	200	R
20 x 3/4"	16	0,054	40 903 020 034S	39,30	1,57	25	200	R
25 x 1/2"	16	0,077	40 903 025 012S	44,20	1,77	25	175	R
25 x 3/4"	16		40 903 025 034S	44,20	1,77	25	175	R
25 x 1"	16	0,072	40 903 025 100S	44,20	1,77	25	150	R
32 x 3/4"	16		40 903 032 034S	57,60	2,30	10	90	R
32 x 1"	16		40 903 032 100S	57,60	2,30	10	90	R
40 x 1 1/4"	16		40 903 040 114S	97,70	3,91		65	R
50 x 1 1/2"	16	0,264	40 903 050 112S	133,50	5,34		50	R
63 x 2"	16	0,434	40 903 063 200S	186,10	7,44		25	R
75 x 2 1/2"	10		40 903 075 212S	403,10	16,12		10	R
75 x 3"	10		40 903 075 300S	403,10	16,12		10	R
90 x 3"	10		40 903 090 300S	505,00	20,20		5	R
110 x 4"	10		40 903 110 400S	980,70	39,23		3	R

40 901

koleno 90° svěrný spoj x vnitřní závit



d x Rp mm x inch	PN bar	m kg	objednáací kód	cena Kč	cena EUR	balení [ks]		sk
						MB	VB	
16 x 1/2"	16	0,061	40 901 016 012	28,00	1,12	25	200	R
16 x 3/4"	16	0,063	40 901 016 034	28,00	1,12	25	200	R
20 x 1/2"	16		40 901 020 012S	42,60	1,70	25	200	R
20 x 3/4"	16	0,062	40 901 020 034	29,00	1,16	25	200	R
25 x 1/2"	16	0,089	40 901 025 012	36,00	1,44	25	150	R
25 x 3/4"	16		40 901 025 034S	50,90	2,04	25	150	R
25 x 1"	16	0,086	40 901 025 100	36,00	1,44	25	125	R
32 x 1/2"	16	0,145	40 901 032 012	43,00	1,72	25	100	R
32 x 3/4"	16		40 901 032 034S	61,80	2,47	25	100	R
32 x 1"	16		40 901 032 100S	61,80	2,47	25	100	R
40 x 1 1/4"	16		40 901 040 114S	141,90	5,68		70	R
50 x 1 1/2"	16	0,279	40 901 050 112S	187,80	7,51		50	R
50 x 2"	16	0,450	40 901 050 200	112,00	4,48		35	R
63 x 2"	16		40 901 063 200S	255,40	10,22		17	R
75 x 2 1/2"	10		40 901 075 212S	452,40	18,10		10	R
90 x 3"	10		40 901 090 300S	837,20	33,49		10	R
110 x 4"	10	1,903	40 901 110 400	820,00	32,80		4	R

40 908

koleno 45°



d mm	PN bar	m g	objednáací kód	cena Kč	cena EUR	balení [ks]		sk
						MB	VB	
20	16	0,124	40 908 020	61,00	2,54	25	150	C
25	16	0,166	40 908 025	107,00	4,46	25	100	C
32	16	0,252	40 908 032	131,00	5,46	25	50	C
40	16	0,429	40 908 040	214,00	8,92		30	C
50	16	0,529	40 908 050	305,00	12,71		20	C
63	16	0,895	40 908 063	410,00	17,08		10	C



## PP svěrné tvarovky

### 40 961



#### T-kus 90°

d mm	PN bar	m g	objednáací kód	cena Kč	cena EUR	balení [ks]		sk
						MB	VB	
16	16	0,127	40 961 016	38,00	1,52	25	100	R
20	16		40 961 020S	70,10	2,80	25	100	R
25	16		40 961 025S	92,70	3,71	10	60	R
32	16		40 961 032S	120,20	4,81	10	30	R
40	16		40 961 040S	211,20	8,45		30	R
50	16		40 961 050S	283,00	11,32		20	R
63	16		40 961 063S	404,00	16,16		11	R
75	10		40 961 075S	742,80	29,71		5	R
90	10		40 961 090S	1 037,50	41,50		5	R
110	10		40 961 110S	1 999,80	79,99		4	R

### 40 981



#### T-kus 90° redukovaný

d x d x d mm	PN bar	m g	objednáací kód	cena Kč	cena EUR	balení [ks]		sk
						MB	VB	
20 x 16 x 20	16	0,120	40 981 020 016	65,00	2,60	25	110	R
20 x 25 x 20	16	0,134	40 981 020 025	75,00	3,00	25	75	R
25 x 20 x 25	16	0,158	40 981 025 020	62,00	2,48	25	50	R
25 x 32 x 25	16	0,189	40 981 025 032	99,00	3,96	15	45	R
32 x 25 x 32	16		40 981 032 025S	111,00	4,44	10	40	R
40 x 32 x 40	16		40 981 040 032S	222,90	8,92		21	R
50 x 32 x 50	16		40 981 050 032G	318,00	13,25		15	C
50 x 40 x 50	16	0,769	40 981 050 040S	300,50	12,02		12	R
63 x 32 x 63	16		40 981 063 032G	422,00	17,58		8	C
63 x 50 x 63	16		40 981 063 050S	396,50	15,86		8	R
75 x 63 x 75	10	2,127	40 981 075 063S	742,80	29,71		5	R
90 x 75 x 90	10		40 981 090 075S	1 181,80	47,27		5	R
110 x 63 x 110	10		40 981 110 063S	2 468,90	98,76		4	R
110 x 90 x 110	10		40 981 110 090S	2 099,20	83,97		4	R

### 40 902



#### T-kus 90° s vnějším závitem

d x R x d mm x inch x mm	PN bar	m g	objednáací kód	cena Kč	cena EUR	balení [ks]		sk
						MB	VB	
16 x 1/2" x 16	16	0,097	40 902 016 012	43,00	1,72	25	125	R
16 x 3/4" x 16	16	0,097	40 902 016 034	43,00	1,72	25	125	R
20 x 1/2" x 20	16	0,890	40 902 020 012	43,00	1,72	25	125	R
20 x 3/4" x 20	16	0,095	40 902 020 034	43,00	1,72	25	125	R
25 x 1/2" x 25	16	0,131	40 902 025 012S	80,10	3,20	25	75	R
25 x 3/4" x 25	16	0,130	40 902 025 034S	80,10	3,20	25	75	R
25 x 1" x 25	16		40 902 025 100S	80,10	3,20	25	75	R
32 x 3/4" x 32	16	0,206	40 902 032 034S	99,40	3,98	15	45	R
32 x 1" x 32	16	0,201	40 902 032 100S	99,40	3,98	15	45	R
40 x 1 1/4" x 40	16		40 902 040 114S	190,30	7,61		35	R
50 x 1 1/2" x 50	16	0,425	40 902 050 112S	263,80	10,55		25	R
63 x 2" x 63	16		40 902 063 200S	510,80	20,43		10	R

### 40 971



#### T-kus 90° s vnitřním závitem

d x Rp x d mm x inch x mm	PN bar	m g	objednáací kód	cena Kč	cena EUR	balení [ks]		sk
						MB	VB	
16 x 1/2" x 16	16	0,101	40 971 016 012	31,00	1,24	25	125	R
16 x 3/4" x 16	16	0,106	40 971 016 034	31,00	1,24	25	125	R
20 x 1/2" x 20	16	0,092	40 971 020 012	39,00	1,56	25	125	R
20 x 3/4" x 20	16	0,096	40 971 020 034	39,00	1,56	25	125	R
25 x 1/2" x 25	16	0,142	40 971 025 012S	81,80	3,27	25	75	R
25 x 3/4" x 25	16	0,136	40 971 025 034S	81,80	3,27	25	75	R
25 x 1" x 25	16	0,142	40 971 025 100	56,00	2,24	25	75	R
32 x 1/2" x 32	16	0,225	40 971 032 012S	101,00	4,04	15	45	R
32 x 3/4" x 32	16		40 971 032 034S	101,00	4,04	10	50	R
32 x 1" x 32	16	0,207	40 971 032 100S	101,00	4,04	15	45	R
40 x 1" x 40	16		40 971 040 100S	205,30	8,21		35	R
40 x 1 1/4" x 40	16	0,362	40 971 040 114S	205,30	8,21		35	R
50 x 1 1/2" x 50	16		40 971 050 112S	273,80	10,95		18	R
63 x 1 1/2" x 63	16	1,207	40 971 063 112S	390,60	15,62		8	R
63 x 2" x 63	16		40 971 063 200S	390,60	15,62		15	R
75 x 2 1/2" x 75	10		40 971 075 212S	693,60	27,74		6	R
90 x 3" x 90	10		40 971 090 300S	1 075,00	43,00		4	R
110 x 4" x 110	10		40 971 110 400S	1 621,70	64,87		2	R

## PP svěrné tvarovky

### 40 941



#### spojka

d mm	PN bar	m g	objednáací kód	cena Kč	cena EUR	balení [ks]		sk
						MB	VB	
16	16	0,081	40 941 016	28,00	1,12	25	175	R
20	16	0,078	40 941 020S	52,60	2,10	25	175	R
25	16		40 941 025S	62,60	2,50	25	100	R
32	16		40 941 032S	80,10	3,20	10	60	R
40	16		40 941 040S	142,70	5,71		45	R
50	16		40 941 050S	194,50	7,78		35	R
63	16		40 941 063S	269,60	10,78		15	R
75	10		40 941 075S	537,50	21,50		8	R
90	10		40 941 090S	664,40	26,58		5	R
110	10		40 941 110S	1 422,20	56,89		3	R

### 40 951



#### spojka redukováaná

d x d mm	PN bar	m g	objednáací kód	cena Kč	cena EUR	balení [ks]		sk
						MB	VB	
20 x 16	16	0,760	40 951 020 016	39,00	1,56	25	175	R
25 x 20	16	0,097	40 951 025 020	41,00	1,64	25	150	R
32 x 20	16		40 951 032 020S	102,60	4,10	10	80	R
32 x 25	16		40 951 032 025S	84,30	3,37	10	80	R
40 x 25	16		40 951 040 025S	171,90	6,88		45	R
40 x 32	16		40 951 040 032S	146,10	5,84		40	R
50 x 32	16		40 951 050 032S	222,90	8,92		30	R
50 x 40	16		40 951 050 040S	189,50	7,58		40	R
63 x 32	16		40 951 063 032S	317,20	12,69		20	R
63 x 40	16		40 951 063 040S	317,20	12,69		15	R
63 x 50	16	0,479	40 951 063 050S	317,20	12,69		25	R
75 x 63	10	1,220	40 951 075 063S	490,00	19,60		12	R
90 x 63	10		40 951 090 063S	763,70	30,55		6	R
90 x 75	10		40 951 090 075S	649,40	25,98		6	R
110 x 63	10		40 951 110 063S	1 600,90	64,04		4	R
110 x 90	10	2,918	40 951 110 090S	1 360,50	54,42		4	R

### 40 921



#### přechod s vnějším závitem

d x R mm x inch	PN bar	m g	objednáací kód	cena Kč	cena EUR	balení [ks]		sk
						MB	VB	
16 x 1/2"	16	0,045	40 921 016 012A	25,20	1,01	25	350	S
16 x 3/4"	16	0,025	40 921 016 034A	25,20	1,01	20	500	S
20 x 1/2"	16	0,044	40 921 020 012S	30,00	1,20	25	350	R
20 x 3/4"	16	0,046	40 921 020 034	22,00	0,88	25	325	R
25 x 1/2"	16	0,060	40 921 025 012	25,00	1,00	25	200	R
25 x 3/4"	16		40 921 025 034S	34,20	1,37	10	200	R
25 x 1"	16		40 921 025 100S	35,90	1,44	10	200	R
32 x 3/4"	16		40 921 032 034S	44,20	1,77	25	125	R
32 x 1"	16		40 921 032 100S	44,20	1,77	10	120	R
32 x 1 1/4"	16		40 921 032 114S	59,30	2,37	25	125	R
40 x 1"	16		40 921 040 100S	88,50	3,54		80	R
40 x 1 1/4"	16		40 921 040 114S	88,50	3,54		80	R
40 x 1 1/2"	16	0,143	40 921 040 112S	99,40	3,98		80	R
50 x 1 1/2"	16		40 921 050 112S	116,00	4,64		35	R
50 x 2"	16		40 921 050 200S	145,20	5,81		60	R
63 x 1 1/2"	16		40 921 063 112S	175,30	7,01		30	R
63 x 2"	16		40 921 063 200S	165,30	6,61		24	R
63 x 2 1/2"	16	0,579	40 921 063 212S	206,20	8,25		20	R
75 x 2"	10	0,773	40 921 075 200S	348,10	13,92		20	R
75 x 2 1/2"	10	0,776	40 921 075 212S	348,10	13,92		20	R
75 x 3"	10		40 921 075 300S	348,10	13,92		18	R
90 x 2"	10		40 921 090 200S	484,10	19,36		10	R
90 x 2 1/2"	10		40 921 090 212S	411,50	16,46		10	R
90 x 3"	10		40 921 090 300S	411,50	16,46		8	R
90 x 4"	10	1,047	40 921 090 400	298,00	11,92		10	R
110 x 4"	10	1,328	40 921 110 400	445,00	17,80		7	R

## PP svěrné tvarovky

### 40 943



### spojka opravárenská

d mm	PN bar	m g	objednáací kód	cena Kč	cena EUR	balení [ks]		sk
						MB	VB	
20	16		40 943 020G	81,00	3,38	25	175	C
25	16		40 943 025G	87,00	3,63	25	100	C
32	16		40 943 032S	133,50	5,34		60	B
32	16		40 943 032G	122,00	5,08			C
40	16		40 943 040G	192,00	8,00		35	C
50	16		40 943 050G	265,00	11,04		25	C
63	16		40 943 063G	314,00	13,08		15	C
75	16		40 943 075G	639,00	26,63		8	C
90	16		40 943 090G	847,00	35,29		5	C
110	16		40 943 110G	1 730,00	72,08		3	C

### 40 923



### přechod s přírubou

d x DN mm	PN bar	m g	objednáací kód	cena Kč	cena EUR	balení [ks]		sk
						MB	VB	
50 x 40	16		40 923 050 040G	492,00	20,50		16	C
50 x 50	16		40 923 050 050	288,00	11,52		16	R
63 x 50	16		40 923 063 050G	492,00	20,50		12	C
63 x 65	16		40 923 063 065	360,00	14,40		12	R
75 x 65	10		40 923 075 065G	718,00	29,92		8	C
75 x 80	16		40 923 075 080G	776,00	32,33		6	C
90 x 80	16		40 923 090 080G	813,00	33,88		5	C
90 x 100	10		40 923 090 100G	936,00	39,00		5	C
110 x 100	16		40 923 110 100G	1 173,00	48,88		4	C

### 40 931



### přechod s vnitřním závitem

d x Rp mm x inch	PN bar	m g	objednáací kód	cena Kč	cena EUR	balení [ks]		sk
						MB	VB	
16 x 1/2"	16	0,046	40 931 016 012	18,00	0,72	25	325	R
16 x 3/4"	16	0,052	40 931 016 034	18,00	0,72	25	300	R
20 x 1/2"	16		40 931 020 012A	32,80	1,31	20	280	S
20 x 3/4"	16	0,051	40 931 020 034	23,00	0,92	25	300	R
25 x 1/2"	16	0,067	40 931 025 012	28,00	1,12	25	200	R
25 x 3/4"	16		40 931 025 034S	40,90	1,64	10	200	R
25 x 1"	16	0,071	40 931 025 100S	40,90	1,64	25	150	R
32 x 3/4"	16		40 931 032 034S	50,10	2,00	10	120	R
32 x 1"	16		40 931 032 100S	50,10	2,00	10	120	R
32 x 1 1/4"	16	0,116	40 931 032 114	53,00	2,12	25	125	R
40 x 1"	16		40 931 040 100S	93,50	3,74		60	R
40 x 1 1/4"	16		40 931 040 114S	93,50	3,74		60	R
50 x 1 1/4"	16	0,212	40 931 050 114	85,00	3,40		70	R
50 x 1 1/2"	16		40 931 050 112S	131,80	5,27		35	R
63 x 1 1/2"	10	0,881	40 931 063 112S	186,10	7,44		30	R
63 x 2"	16		40 931 063 200S	186,10	7,44		24	R
75 x 2"	10	0,881	40 931 075 200S	383,10	15,32		18	R
75 x 2 1/2"	10		40 931 075 212S	383,10	15,32		18	R
90 x 2"	10		40 931 090 200S	552,60	22,10		10	R
90 x 2 1/2"	10	1,057	40 931 090 212	295,00	11,80		10	R
90 x 3"	10		40 931 090 300S	469,90	18,80		10	R
110 x 3"	10	1,349	40 931 110 300	580,00	23,20		6	R
110 x 4"	10	1,404	40 931 110 400S	1 114,30	44,57		6	R

### 40 917



### víčko

d mm	PN bar	m g	objednáací kód	cena Kč	cena EUR	balení [ks]		sk
						MB	VB	
16	16	0,044	40 917 016	22,00	0,88	25	400	R
20	16	0,042	40 917 020	22,00	0,88	25	400	R
25	16		40 917 025S	40,10	1,60	25	250	R
32	16	0,100	40 917 032A	46,80	1,87	10	150	S
32	16		40 917 032S	50,10	2,00	10	120	R
40	16		40 917 040S	88,50	3,54		110	R
50	16	0,173	40 917 050S	130,20	5,21		75	R
63	16		40 917 063S	176,10	7,04		24	R
75	10		40 917 075S	443,20	17,73		15	R
90	10		40 917 090S	506,60	20,26		8	R
110	10		40 917 110S	1 091,70	43,67		6	R

## PP svěrné tvarovky

40 911



### přechod s kovovým vnějším závitem

zástřík z niklované mosazi

d x R mm x inch	PN bar	m g	objednáací kód	cena Kč	cena EUR	balení [ks]		sk
						MB	VB	
40 x 1 1/4"	16	0,615	40 911 040 114	462,00	18,48		4	R

40 912



### přechod s kovovým vnitřním závitem

zástřík z niklované mosazi

d x Rp mm x inch	PN bar	m g	objednáací kód	cena Kč	cena EUR	balení [ks]		sk
						MB	VB	
32 x 1"	16	0,290	40 912 032 100	307,00	12,28		12	R

40 904



### nástěnka

d x Rp mm x inch	PN bar	m g	objednáací kód	cena Kč	cena EUR	balení [ks]		sk
						MB	VB	
20 x 1/2"	16		40 904 020 012	57,70	2,40			C
25 x 3/4"	16		40 904 025 034	69,70	2,90			C

40 925



### nerezový pojistný kroužek

**DOPRODEJ**

d mm	PN bar	m g	objednáací kód	cena Kč	cena EUR	balení [ks]		sk
						MB	VB	
25			40 925 025	24,00	1,00			D
40			40 925 040	48,00	2,00			D
50			40 925 050	65,00	2,71			D

40 944



### univerzální přechodová spojka

d x d mm	PN bar	m g	objednáací kód	cena Kč	cena EUR	balení [ks]		sk
						MB	VB	
25 x 20-27	16		40 944 025	239,20	9,97			E
32 x 27-34	16		40 944 032	305,20	12,72			E
40 x 35-50	16		40 944 040	761,00	31,71			E
50 x 35-50	16		40 944 050	745,00	31,04			E

pro spojení PE x pozinkovaná ocel  
měď  
olovo  
PVC-U  
PP  
PE nestandardních rozměrů  
atd.

## PP kulové kohouty

### 40 VSR 16G



#### PP kulový kohout - svěrný spoj x svěrný spoj

d mm	PN bar	m kg	objednací kód	cena Kč	cena EUR	balení [ks]		sk
						MB	VB	
20	10	0,111	40 VSR 16G 020	245,00	10,21		75	B
25	10	0,263	40 VSR 16G 025	310,00	12,92		28	B
32	10	0,326	40 VSR 16G 032	353,00	14,71		28	B
40	10	0,672	40 VSR 16G 040	481,00	20,04		12	B
50	10	0,821	40 VSR 16G 050	549,00	22,88		12	B
63	10	1,440	40 VSR 16G 063	819,00	34,13		5	B

### 40 VSR 16P



#### PP kulový kohout - svěrný spoj x vnitřní závit

d x G mm x inch	PN bar	m kg	objednací kód	cena Kč	cena EUR	balení [ks]		sk
						MB	VB	
20 x 1/2"	10		40 VSR 16P 020	224,00	9,33			B
25 x 3/4"	10		40 VSR 16P 025	255,00	10,63			B
32 x 1"	10		40 VSR 16P 032	328,00	13,67			B
40 x 1 1/4"	10		40 VSR 16P 040	586,00	24,42			B
50 x 1 1/2"	10		40 VSR 16P 050	656,00	27,33			B
63 x 2"	10		40 VSR 16P 063	978,00	40,75			B

### 40 VSR 16M



#### PP kulový kohout - svěrný spoj x vnější závit

d x G mm x inch	PN bar	m kg	objednací kód	cena Kč	cena EUR	balení [ks]		sk
						MB	VB	
20 x 1/2"	10		40 VSR 16M 020	224,00	9,33			B
25 x 3/4"	10		40 VSR 16M 025	255,00	10,63			B
32 x 1"	10		40 VSR 16M 032	328,00	13,67			B
40 x 1 1/4"	10		40 VSR 16M 040	586,00	24,42			B
50 x 1 1/2"	10		40 VSR 16M 050	656,00	27,33			B
63 x 2"	10		40 VSR 16M 063	978,00	40,75			B

## Mosazné svěrné tvarovky

### 40 821

#### přechod s vnějším závitem



d x R mm x inch	PN bar	m g	objednáací kód	cena Kč	cena EUR	balení [ks]		sk
						MB	VB	
20 x 3/8"	25		40 821 020 038	187,00	7,79	30	120	D
20 x 1/2"	25		40 821 020 012	190,00	7,92	30	120	D
25 x 1/2"	25		40 821 025 012	275,00	11,46	20	80	D
25 x 3/4"	25		40 821 025 034	249,00	10,38	20	80	D
25 x 1"	25		40 821 025 100	275,00	11,46	20	80	D
32 x 3/4"	25		40 821 032 034	455,00	18,96	12	48	D
32 x 1"	25		40 821 032 100	407,00	16,96	12	48	D
32 x 1 1/4"	25		40 821 032 114	455,00	18,96	12	48	D
40 x 1"	25		40 821 040 100	700,00	29,17	8	32	D
40 x 1 1/4"	25		40 821 040 114	688,00	28,67	8	32	D
40 x 1 1/2"	25		40 821 040 112	693,00	28,88	8	32	D
50 x 1 1/2"	25		40 821 050 112	925,00	38,54	6	24	D
63 x 2"	25		40 821 063 200	2 001,70	83,40	3	12	D
63 x 2 1/2"	25		40 821 063 212	1 705,00	71,04	2	8	D
75x 2 1/2"	25		40 821 075 212	3 178,00	132,42		8	D
90 x 3 "	25		40 821 090 300	4 487,00	186,96		6	D
110 x 4"	25		40 821 110 400	9 337,00	389,04		3	D

### 40 831

#### přechod s vnitřním závitem



d x Rp mm x inch	PN bar	m g	objednáací kód	cena Kč	cena EUR	balení [ks]		sk
						MB	VB	
20 x 1/2"	25		40 831 020 012	170,00	7,08	30	120	D
20 x 3/4"	25		40 831 020 034	176,00	7,33	30	120	D
25 x 1/2"	25		40 831 025 012	273,00	11,38	20	80	D
25 x 3/4"	25		40 831 025 034	249,00	10,38	20	80	D
25 x 1"	25		40 831 025 100	259,00	10,79	20	80	D
32 x 3/4"	25		40 831 032 034	428,00	17,83	12	48	D
32 x 1"	25		40 831 032 100	387,00	16,13	12	48	D
32 x 1 1/4"	25		40 831 032 114	395,00	16,46	12	48	D
40 x 1 1/4"	25		40 831 040 114	653,00	27,21	8	32	D
40 x 1 1/2"	25		40 831 040 112	688,00	28,67	8	32	D
50 x 1 1/2"	25		40 831 050 112	948,00	39,50	6	24	D
50 x 2"	25		40 831 050 200	998,00	41,58	6	24	D
63 x 1 1/2"	25		40 831 063 112	---	---			-
63 x 2"	25		40 831 063 200	1 583,00	65,96	3	12	D
63 x 2 1/2"	25		40 831 063 212	1 664,00	69,33	3	12	D
75x 2 1/2"	25		40 831 075 212	3 140,00	130,83		8	D
90 x 3 "	25		40 831 090 300	4 512,00	188,00		6	D
110 x 4"	25		40 831 110 400	9 385,00	391,04		4	D

### 40841

#### spojka



d x R mm x inch	PN bar	m g	objednáací kód	cena Kč	cena EUR	balení [ks]		sk
						MB	VB	
20 x 20	25		40 841 020	300,00	12,50	20	80	D
25 x 25	25		40 841 025	407,00	16,96	15	60	D
32 x 32	25		40 841 032	619,00	25,79	10	0	D
40 x 40	25		40 841 040	1 008,00	42,00	4	16	D
50 x 50	25		40 841 050	1 359,00	56,63	4	16	D
63 x 63	25		40 841 063	2 452,00	102,17	2	8	D
75 x 75	25		40 841 075	5 399,00	224,96		6	D
90 x 90	25		40 841 090	7 759,00	323,29		4	D
110 x 110	25		40 841 110	17 234,00	718,08		2	D

## Mosazné svěrné tvarovky

40 842



### přechod s převlečnou maticí

d x R mm x inch	PN bar	m g	objednáací kód	cena Kč	cena EUR	balení [ks]		sk
						MB	VB	
20 x 3/4"	25		40 842 020 034	442,00	18,42	15	60	D
25 x 3/4"	25		40 842 025 034	468,00	19,50	15	60	D
25 x 1"	25		40 842 025 100	549,00	22,88	10	40	D
32 x 1"	25		40 842 032 100	699,00	29,13	10	40	D
40 x 1 1/2"	25		40 842 040 112	1 476,00	61,50	6	24	D

40 803



### koleno 90° s vnějším závitem

d x R mm x inch	PN bar	m g	objednáací kód	cena Kč	cena EUR	balení [ks]		sk
						MB	VB	
20 x 1/2"	25		40 803 020 012	281,00	11,71	25	100	D
25 x 3/4"	25		40 803 025 034	381,00	15,88	15	60	D
32 x 1"	25		40 803 032 100	621,00	25,88	10	40	D
40 x 1 1/4"	25		40 803 040 114	1 067,00	44,46	5	20	D
50 x 1 1/2"	25		40 803 050 112	1 444,00	60,17	3	12	D
63 x 2"	25		40 803 063 200	2 528,00	105,33	2	8	D
75 x 2 1/2"	25		40 803 075 212	4 822,00	200,92		4	D
90 x 3"	25		40 803 090 300	7 962,00	331,75		3	D

40 801



### koleno 90° s vnitřním závitem

d x R mm x inch	PN bar	m g	objednáací kód	cena Kč	cena EUR	balení [ks]		sk
						MB	VB	
20 x 1/2"	25		40 801 020 012	264,00	11,00	25	100	D
25 x 3/4"	25		40 801 025 034	361,00	15,04	15	60	D
32 x 1"	25		40 801 032 100	570,00	23,75	10	40	D
40 x 1 1/4"	25		40 801 040 114	980,00	40,83	5	20	D
50 x 1 1/2"	25		40 801 050 112	1 353,00	56,38	3	12	D
63 x 2"	25		40 801 063 200	2 420,00	100,83	2	8	D
75 x 2 1/2"	25		40 801 075 212	4 635,00	193,13		4	D
90 x 3"	25		40 801 090 300	8 214,00	342,25		3	D

40 891



### koleno 90°

d x R mm x inch	PN bar	m g	objednáací kód	cena Kč	cena EUR	balení [ks]		sk
						MB	VB	
20 x 20	25		40 891 020	387,00	16,13	20	80	D
25 x 25	25		40 891 025	526,00	21,92	15	60	D
32 x 32	25		40 891 032	818,00	34,08	10	0	D
40 x 40	25		40 891 040	1 372,00	57,17	4	16	D
50 x 50	25		40 891 050	1 918,00	79,92	4	16	D
63 x 63	25		40 891 063	3 586,00	149,42	2	8	D
75 x 75	25		40 891 075	6 707,00	279,46		6	D
90 x 90	25		40 891 090	11 153,00	464,71		4	D

40 802



### T-kus s vnějším závitem

d x R mm x inch	PN bar	m g	objednáací kód	cena Kč	cena EUR	balení [ks]		sk
						MB	VB	
20 x 1/2" x 20	25		40 802 020 012	621,00	25,88	15	60	D
25 x 3/4" x 25	25		40 802 025 034	592,00	24,67	10	40	D
40 x 1 1/4" x 40	25		40 802 040 114	1 509,00	62,88	3	12	D
50 x 1 1/2" x 50	25		40 802 050 112	2 160,00	90,00	2	8	D
63 x 2" x 63	25		40 802 063 200	3 867,00	161,13	1	4	D

## Mosazné svěrné tvarovky

40 871



### T-kus s vnitřním závitem

d x R mm x inch	PN bar	m g	objednáací kód	cena Kč	cena EUR	balení [ks]		sk
						MB	VB	
25 x 1/2" x 25	25		40 871 025 012	642,00	26,75	10	40	D
25 x 3/4" x 25	25		40 871 025 034	576,00	24,00	10	40	D
32 x 3/4" x 32	25		40 871 032 034	933,00	38,88	5	20	D
32 x 1" x 32	25		40 871 032 100	908,00	37,83	5	20	D
40 x 1 1/4" x 40	25		40 871 040 114	1 524,00	63,50	3	12	D
50 x 1 1/4" x 50	25		40 871 050 114	---	---	1	4	-
50 x 1 1/2" x 50	25		40 871 050 112	2 162,00	90,08	1	4	D
63 x 1 1/2" x 63	25		40 871 063 112	4 288,00	178,67	1	4	D
63 x 2" x 63	25		40 871 063 200	4 072,00	169,67	1	4	D
75 x 2" x 75	25		40 871 075 200	7 302,00	304,25		2	D
90 x 2 1/2" x 90	25		40 871 090 212	10 678,00	444,92		1	D

40 861



### T-kus

d x R mm x inch	PN bar	m g	objednáací kód	cena Kč	cena EUR	balení [ks]		sk
						MB	VB	
20 x 20 x 20	25		40 861 020	533,00	22,21	10	40	D
25 x 25 x 25	25		40 861 025	713,00	29,71	8	32	D
32 x 32 x 32	25		40 861 032	1 166,00	48,58	5	20	D
40 x 40 x 40	25		40 861 040	1 993,00	83,04	2	8	D
50 x 50 x 50	25		40 861 050	2 786,00	116,08	1	4	D
63 x 63 x 63	25		40 861 063	4 994,00	208,08	1	4	D
75 x 75 x 75	25		40 861 075	9 697,00	404,04		1	D
90 x 90 x 90	25		40 861 090	---	---		1	-

## Litínové svěrné tvarovky

40 832



### přechod s vnitřním závitem

d x Rp mm x inch	PN bar	m g	objednáací kód	cena Kč	cena EUR	balení [ks]		sk
						MB	VB	
24,5-27,3 x 3/4"	16		40 832 034	319,50	13,31			H
31,4-34,2 x 1"	16		40 832 100	390,50	16,27			H
39,5-42,9 x 5/4"	16		40 832 114	530,70	22,11			H
47,8-51,5 x 6/4"	16		40 832 112	605,60	25,23			H
59,7-63,6 x 2"	16		40 832 200	962,60	40,11			H

univerzálně použitelné na všechny druhy ocelových a PE trubek podle uvedeného rozsahu průměru



40 654

navrtávací objímka s výztužným kroužkem  
a plochým těsněním NBR, PN16 / PN10

d x Rp mm x inch	PN bar	m g	objednáací kód	cena Kč	cena EUR	balení [ks]		sk
						MB	VB	
25 x 1/2"	16	0,110	40 654 025 012	54,30	2,17	1	150	R
25 x 3/4"	16	0,123	40 654 025 034	54,30	2,17	1	150	R
32 x 1/2"	16	0,103	40 654 032 012	58,70	2,35	1	150	R
32 x 3/4"	16	0,115	40 654 032 034	58,70	2,35	1	150	R
32 x 1"	16	0,162	40 654 032 100	65,00	2,60	1	100	R
40 x 1/2"	16	0,135	40 654 040 012	71,90	2,88	1	100	R
40 x 3/4"	16	0,146	40 654 040 034	71,90	2,88	1	100	R
40 x 1"	16	0,153	40 654 040 100	71,90	2,88	1	100	R
50 x 1/2"	16	0,196	40 654 050 012	91,70	3,67	1	100	R
50 x 3/4"	16	0,209	40 654 050 034	91,70	3,67	1	100	R
50 x 1"	16	0,217	40 654 050 100	91,70	3,67	1	100	R
63 x 1/2"	16	0,212	40 654 063 012	104,60	4,18	1	70	R
63 x 3/4"	16	0,222	40 654 063 034	104,60	4,18	1	70	R
63 x 1"	16	0,228	40 654 063 100	104,60	4,18	1	70	R
63 x 1 1/4"	16	0,275	40 654 063 114	104,60	4,18	1	60	R
63 x 1 1/2"	16	0,268	40 654 063 112	143,10	5,72	1	60	R
75 x 1/2"	16	0,364	40 654 075 012	124,80	4,99	1	40	R
75 x 3/4"	16	0,376	40 654 075 034	124,80	4,99	1	40	R
75 x 1"	16	0,384	40 654 075 100	124,80	4,99	1	40	R
75 x 1 1/4"	16	0,428	40 654 075 114	124,80	4,99	1	40	R
75 x 1 1/2"	16	0,421	40 654 075 112	181,60	7,26	1	40	R
75 x 2 "	16	0,437	40 654 075 200	181,60	7,26	1	40	R
90 x 1/2"	16	0,412	40 654 090 012	165,10	6,60	1	34	R
90 x 3/4"	16	0,421	40 654 090 034	165,10	6,60	1	34	R
90 x 1"	16	0,432	40 654 090 100	165,10	6,60	1	34	R
90 x 1 1/4"	16	0,747	40 654 090 114	165,10	6,60	1	34	R
90 x 1 1/2"	16	0,472	40 654 090 112	187,20	7,49	1	30	R
90 x 2"	16	0,481	40 654 090 200	187,20	7,49	1	30	R
110 x 1/2"	16	0,511	40 654 110 012	234,90	9,40	1	20	R
110 x 3/4"	16	0,523	40 654 110 034	234,90	9,40	1	20	R
110 x 1"	16	0,533	40 654 110 100	234,90	9,40	1	20	R
110 x 1 1/4"	16	0,566	40 654 110 114	234,90	9,40	1	20	R
110 x 1 1/2"	16	0,565	40 654 110 112	244,00	9,76	1	20	R
110 x 2"	16	0,570	40 654 110 200	244,00	9,76	1	20	R
110 x 3 "	6	1,120	40 654 110 300	458,60	18,34		12	R
125 x 3/4"	16	0,590	40 654 125 034	366,90	14,68	1	20	R
125 x 1"	16	0,592	40 654 125 100	366,90	14,68	1	20	R
125 x 1 1/4"	16	0,627	40 654 125 114	366,90	14,68	1	20	R
125 x 1 1/2"	16	0,629	40 654 125 112	394,40	15,78	1	20	R
125 x 2"	16	0,632	40 654 125 200	394,40	15,78	1	20	R
125 x 3"	6	1,012	40 654 125 300	495,30	19,81		12	R
140 x 3/4"	16	0,843	40 654 140 034	403,60	16,14		20	R
140 x 1"	16	0,849	40 654 140 100	403,60	16,14		20	R
140 x 1 1/4"	16	0,892	40 654 140 114	403,60	16,14		20	R
140 x 1 1/2"	16	0,880	40 654 140 112	467,80	18,71		20	R
140 x 2"	16	0,898	40 654 140 200	467,80	18,71		20	R
140 x 3"	16	1,132	40 654 140 300	513,60	20,54		10	R
160 x 1/2"	16	0,899	40 654 160 012	421,90	16,88		20	R
160 x 3/4"	16	0,908	40 654 160 034	421,90	16,88		20	R
160 x 1"	16	0,917	40 654 160 100	421,90	16,88		20	R
160 x 1 1/4"	16	0,954	40 654 160 114	421,90	16,88		20	R
160 x 1 1/2"	16	0,950	40 654 160 112	486,20	19,45		20	R
160 x 2"	16	0,956	40 654 160 200	486,20	19,45		20	R
160 x 3"	10	1,185	40 654 160 300	633,00	25,32		10	R

40 654

navrtávací objímka s výztužným kroužkem  
a plochým těsněním NBR, PN16 / PN10



d x Rp mm x inch	PN bar	m g	objednáací kód	cena Kč	cena EUR	balení [ks]		sk
						MB	VB	
180 x 1"	10	1,980	40 654 180 100	704,50	28,18		7	R
180 x 2"	10	2,018	40 654 180 200	704,50	28,18		7	R
180 x 3"	10	2,043	40 654 180 300	832,90	33,32		7	R
200 x 1 1/2"	10	1,912	40 654 200 112	799,90	32,00		8	R
200 x 2"	10	1,912	40 654 200 200	799,90	32,00		7	R
200 x 3"	10	1,980	40 654 200 300	937,50	37,50		7	R
200 x 4"	10	2,020	40 654 200 400	937,50	37,50		7	R
225 x 1 1/2"	10	2,049	40 654 225 112	1 131,90	45,28		5	R
225 x 2"	10	2,050	40 654 225 200	1 131,90	45,28		5	R
225 x 3"	10	2,150	40 654 225 300	1 284,20	51,37		5	R
225 x 4"	10	2,184	40 654 225 400	1 284,20	51,37		5	R
250 x 2"	10	2,436	40 654 250 200	1 229,20	49,17		5	R
250 x 3 "	10	2,466	40 654 250 300	1 357,60	54,30		5	R
250 x 4"	10	2,478	40 654 250 400	1 357,60	54,30		5	R
280 x 6/4"	10		40 654 280 112	1 753,80	70,15		2	R
280 x 2"	10		40 654 280 200	1 753,80	70,15		2	R
315 x 2"	10	4,120	40 654 315 200	1 808,90	72,36		2	R
315 x 3"	10	4,267	40 654 315 300	1 926,30	77,05		2	R
315 x 4"	10	4,279	40 654 315 400	1 926,30	77,05		2	R

40 655

navrtávací objímka s výztužným kroužkem  
a plochým těsněním NBR, PN16 / PN10, nerezové šrouby



d x Rp mm x inch	PN bar	m g	objednáací kód	cena Kč	cena EUR	balení [ks]		sk
						MB	VB	
25 x 1/2"	16	0,110	40 655 025 012	129,00	5,38	1		D
25 x 3/4"	16	0,123	40 655 025 034	122,00	5,08	1		D
32 x 1/2"	16	0,103	40 655 032 012	138,00	5,75	1		D
32 x 3/4"	16	0,115	40 655 032 034	138,00	5,75	1		D
32 x 1"	16	0,164	40 655 032 100	139,00	5,79	1		D
40 x 1/2"	16	0,136	40 655 040 012	165,00	6,88	1		D
40 x 3/4"	16	0,148	40 655 040 034	156,00	6,50	1		D
40 x 1"	16	0,155	40 655 040 100	165,00	6,88	1		D
50 x 1/2"	16	0,200	40 655 050 012	205,00	8,54	1		D
50 x 3/4"	16	0,213	40 655 050 034	205,00	8,54	1		D
50 x 1"	16	0,221	40 655 050 100S	121,40	4,86	1	100	R
50 x 1 1/4"	16	0,225	40 655 050 114	231,00	9,63	1		D
63 x 1/2"	16	0,216	40 655 063 012	231,00	9,63	1		D
63 x 3/4"	16	0,226	40 655 063 034S	144,60	5,78	1	70	R
63 x 1"	16	0,232	40 655 063 100S	144,60	5,78	1	70	R
63 x 1 1/4"	16	0,272	40 655 063 114	241,00	10,04	1		D
63 x 1 1/2"	16	0,279	40 655 063 112S	169,50	6,78	1	60	R
75 x 1/2"	16	0,364	40 655 075 012	292,00	12,17	1		D
75 x 3/4"	16	0,376	40 655 075 034	292,00	12,17	1		D
75 x 1"	16	0,428	40 655 075 100	292,00	12,17	1		D
75 x 1 1/4"	16	0,421	40 655 075 114	310,00	12,92	1		D
75 x 1 1/2"	16	0,428	40 655 075 112	310,00	12,92	1		D
75 x 2 "	16	0,437	40 655 075 200	310,00	12,92	1		D
90 x 1/2"	16	0,412	40 655 090 012	322,00	13,42	1		D
90 x 3/4"	16	0,421	40 655 090 034	322,00	13,42	1		D
90 x 1"	16	0,432	40 655 090 100	322,00	13,42	1		D
90 x 1 1/4"	16	0,472	40 655 090 114	342,00	14,25	1		D
90 x 1 1/2"	16	0,474	40 655 090 112S	227,50	9,10	1	30	R
90 x 2"	16	0,481	40 655 090 200S	227,50	9,10	1	30	R
110 x 1/2"	16	0,511	40 655 110 012	361,00	15,04	1		D
110 x 3/4"	16	0,523	40 655 110 034	361,00	15,04	1		D

40 655

navrtávací objímka s výztužným kroužkem  
a plochým těsněním NBR, PN16 / PN10, nerezové šrouby



d x Rp mm x inch	PN bar	m g	objednáací kód	cena Kč	cena EUR	balení [ks]		sk
						MB	VB	
110 x 1"	16	0,533	40 655 110 100S	273,40	10,94	1	20	R
110 x 1 1/4"	16	0,565	40 655 110 114	370,00	15,42	1		D
110 x 1 1/2"	16	0,566	40 655 110 112	370,00	15,42	1		D
110 x 2"	16	0,570	40 655 110 200	370,00	15,42	1		D
110 x 3 "	6	1,120	40 655 110 300	1 172,00	48,83	1		D
125 x 1/2"	16	0,578	40 655 125 012	452,00	18,83	1		D
125 x 3/4"	16	0,520	40 655 125 034	430,00	17,92	1		D
125 x 1"	16	0,592	40 655 125 100	452,00	18,83	1		D
125 x 1 1/4"	16	0,629	40 655 125 114	438,00	18,25	1		D
125 x 1 1/2"	16	0,627	40 655 125 112	463,00	19,29	1		D
125 x 2"	16	0,632	40 655 125 200	438,00	18,25	1		D
125 x 3"	6	1,012	40 655 125 300	1 272,00	53,00			D
125 x 4"	6	1,071	40 655 125 400	1 296,00	54,00			D
140 x 1/2"	16	0,830	40 655 140 012	649,00	27,04			D
140 x 3/4"	16	0,843	40 655 140 034	616,00	25,67			D
140 x 1"	16	0,849	40 655 140 100	649,00	27,04			D
140 x 1 1/4"	16	0,880	40 655 140 114	658,00	27,42			D
140 x 1 1/2"	16	0,892	40 655 140 112	658,00	27,42			D
140 x 2"	16	0,898	40 655 140 200	658,00	27,42			D
140 x 3"	16	1,132	40 655 140 300	1 305,00	54,38			D
140 x 4"	16	1,196	40 655 140 400	1 316,00	54,83			D
160 x 1/2"	16	0,896	40 655 160 012	873,00	36,38			D
160 x 3/4"	16	0,908	40 655 160 034	829,00	34,54			D
160 x 1"	16	0,917	40 655 160 100	873,00	36,38			D
160 x 1 1/4"	16	0,950	40 655 160 114	837,00	34,88			D
160 x 1 1/2"	16	0,954	40 655 160 112	880,00	36,67			D
160 x 2"	16	0,956	40 655 160 200	880,00	36,67			D
160 x 3"	10	1,185	40 655 160 300	1 392,00	58,00			D
160 x 4"	10	1,262	40 655 160 400	1 330,00	55,42			D
180 x 1"	10	1,980	40 655 180 100	1 997,00	83,21			D
180 x 1 1/4"	10	2,013	40 655 180 114	1 997,00	83,21			D
180 x 1 1/2"	10	1,980	40 655 180 112	1 997,00	83,21			D
180 x 2"	10	2,018	40 655 180 200	1 997,00	83,21			D
180 x 3"	10	2,043	40 655 180 300	1 997,00	83,21			D
180 x 4"	10	2,107	40 655 180 400	1 997,00	83,21			D
200 x 1 1/2"	10	1,985	40 655 200 112	3 089,00	128,71			D
200 x 2"	10	1,946	40 655 200 200	3 089,00	128,71			D
200 x 3"	10	1,980	40 655 200 300	3 111,00	129,63			D
200 x 4"	10	2,035	40 655 200 400	2 979,00	124,13			D
225 x 1 1/2"	10	2,049	40 655 225 112	3 420,00	142,50			D
225 x 2"	10	2,050	40 655 225 200	3 252,00	135,50			D
225 x 3"	10	2,150	40 655 225 300	3 345,00	139,38			D
225 x 4"	10	2,184	40 655 225 400	3 426,00	142,75			D
250 x 2"	10	2,472	40 655 250 200	3 995,00	166,46			D
250 x 3 "	10	2,466	40 655 250 300	4 080,00	170,00			D
250 x 4"	10	2,493	40 655 250 400	4 159,00	173,29			D
280 x 2"	10	3,522	40 655 280 200	5 528,00	230,33			D
280 x 3"	10	3,591	40 655 280 300	5 498,00	229,08			D
280 x 4"	10	3,633	40 655 280 400	5 498,00	229,08			D
315 x 2"	10	4,156	40 655 315 200	5 601,00	233,38			D
315 x 3"	10	4,391	40 655 315 300	5 573,00	232,21			D
315 x 4"	10	4,418	40 655 315 400	5 573,00	232,21			D

## PP navrtávací objímky

40 651



### navrtávací objímka s výztužným kroužkem PN10

s plochým těsněním NBR

d x Rp mm x inch	PN bar	m g	objednáací kód	cena Kč	cena EUR	balení [ks]		sk
						MB	VB	
25 x 3/4"	10	0,096	40 651 025 034	34,00	1,36	1	150	D
40 x 1/2"	10	0,127	40 651 040 012	44,00	1,76	1	100	D
40 x 1"	10	0,135	40 651 040 100	44,00	1,76	1	100	D

40 650



### navrtávací objímka bez výztužného kroužku PN10

těsnění O-kroužek NBR

d x Rp mm x inch	PN bar	m g	objednáací kód	cena Kč	cena EUR	balení [ks]		sk
						MB	VB	
25 x 1/2"	10	0,055	40 650 025 012	17,00	0,68	1	150	C
25 x 3/4"	10	0,058	40 650 025 034	17,00	0,68	1	150	C
32 x 1/2"	10	0,058	40 650 032 012	18,80	0,75	1	150	C
32 x 3/4"	10	0,063	40 650 032 034	28,10	1,12	1	150	C
40 x 1/2"	10	0,062	40 650 040 012	22,50	0,90	1	100	C
40 x 3/4"	10	0,066	40 650 040 034	31,80	1,27	1	100	C
40 x 1"	10	0,069	40 650 040 100	24,30	0,97	1	100	C
50 x 1/2"	10	0,070	40 650 050 012	26,40	1,06	1	100	C
50 x 3/4"	10	0,073	40 650 050 034	37,40	1,50	1	100	C
50 x 1"	10	0,076	40 650 050 100	31,50	1,26	1	100	C
63 x 1/2"	10	0,217	40 650 063 012	40,10	1,60	1	70	C
63 x 3/4"	10	0,218	40 650 063 034	62,70	2,51	1	70	C
63 x 1"	10	0,221	40 650 063 100	49,00	1,96	1	70	C
75 x 1/2"	10	0,266	40 650 075 012	48,60	1,94	1	40	C
75 x 1"	10	0,248	40 650 075 100	48,60	1,94	1	40	C
75 x 1 1/4"	10	0,256	40 650 075 114	48,60	1,94	1	40	C
90 x 1/2"	10	0,286	40 650 090 012	51,60	2,06	1	70	C
90 x 1"	10	0,291	40 650 090 100	51,60	2,06	1	40	C
90 x 1 1/4"	10	0,296	40 650 090 114	51,60	2,06	1	40	C
110 x 1/2"	10	0,319	40 650 110 012	60,10	2,40	1	70	C
110 x 1"	10	0,324	40 650 110 100	60,10	2,40	1	40	C
110 x 1 1/4"	10	0,329	40 650 110 114	60,10	2,40	1	40	C
110 x 1 1/2"	10	0,327	40 650 110 112	70,40	2,93	1	40	C
110 x 2"	10	0,339	40 650 110 200	70,40	2,93	1	40	C

40 653



### navrtávací objímka s hadicovým trnem

d mm	PN bar	m g	objednáací kód	cena Kč	cena EUR	balení [ks]		sk
						MB	VB	
32 x 16	10	0,057	40 653 032 016	17,80	0,71		300	B
40 x 16	10	0,059	40 653 040 016	22,10	0,88		250	B

40 663



### dvojité navrtávací objímky s hadicovým trnem

d mm	PN bar	m g	objednáací kód	cena Kč	cena EUR	balení [ks]		sk
						MB	VB	
32 x 16	10	0,062	40 663 032 016	19,80	0,79		300	B
40 x 16	10	0,062	40 663 040 016	26,30	1,05		250	B

## PP-R

---

Trubky a tvarovky PP-R jsou vyráběny ze statistického kopolymeru polypropylenu (také označovaného jako random kopolymer nebo polypropylen typu 3). Tento materiál je charakteristický svými výbornými vlastnostmi, jako je elasticita, těsnost, tuhost, odolnost vůči vysokým teplotám, apod. Pro označení materiálu se používá zkratka PP-R.

Novou, vylepšenou, variantou základního statistického kopolymeru je tzv. nukleovaný random kopolymer polypropylenu. Tento materiál se vyznačuje jemnější a pevnější krystalickou strukturou, což má za následek vyšší odolnost proti vysokým tlakům a teplotám oproti „klasickému“ PP-R. Používá se zvláště na výrobu trubek a je plně kompatibilní s klasickým PP-R. Pro označení materiálu se používá zkratka PP-RCT (C = crystalinity, T = temperature).

### Hlavní výhody systému PP-R:

- Hygienická nezávadnost
- Nekoroduje, nezarůstá
- Snadná, rychlá a čistá montáž
- Malá hlučnost, nízké tlakové ztráty třením
- Při správné instalaci a dodržování provozních podmínek životnost více než 50 let.
- Ekologicky šetrný výrobek (možnost recyklace nebo nezávadného spalování)

### Oblasti použití systému PP-R:

Systém PP-R je ideální pro použití na rozvody vody a dalších kapalin a to zejména v následujících oblastech:

- Sanitární technika a klimatizace
- Doprava pitné vody a jiných potravinářských tekutin
- Systémy vytápění
- Doprava vody, vzduchu a případně i dalších chemikálií v průmyslových podnicích

### Základní informace

- trubky PP-RCT v dimenzích od d16 mm do d110 mm
- tvarovky RR-R/PP-RCT v dimenzích od d16 mm do d110 mm
- provozní tlaky PN16 a PN25
- teplotní rozsah: od 0°C do +80°C
- spojování svařováním polyfúzně

Pro utěsnění závitových spojů je zakázáno používat konopí – důvodem je vysoký utahovací moment a možnost vytržení zástříku z plastu, u vnitřních zástříků je nebezpečí popraskání kovu. Výhradně se doporučuje používat teflonové pásky nebo tmely na bázi teflonu, které je nutné aplikovat dle návodu a doporučení výrobců. Svařování plastů se smí provádět od teploty okolí + 5 °C, pro přípravu prefabrikátů se doporučuje zateplit pracovní prostor na min. +10 °C. Pro správnou funkci plastového rozvodu je také důležitá jeho izolace, která zabezpečuje pro dopravované médium požadované technologické podmínky. Vnitřní vodovodní potrubí se nesmí vést prostory, kde za běžného provozu klesá teplota pod 5°C, pokud rozvod není zabezpečen proti vlivům poklesu teploty (např. izolací). Potrubí studené vody (vedené volně, uložené v drážkách v instalačních kanálech apod.) musí být zabezpečeno proti orosování. Obdobně musí být potrubí teplé vody a cirkulační potrubí s nucenou cirkulací vody tepelně izolováno z důvodu tepelných ztrát a lineární roztažnosti v souladu s požadavky platných norem.

**Tabulka provozních parametrů potrubí systému PP-R**

V tabulce provozních parametrů jsou stanoveny hodnoty dovolených provozních tlaků při konkrétních teplotách vody v potrubí s ohledem na požadovanou životnost systému.

VODOVODY - bezpečnostní koeficient 1,25							
Teplota [°C]	Provozní doba [roky]	Maximální přípustný provozní tlak [bar]					
		PP-R CLASSIC	PP-R CLASSIC PP-R FASER	PP-R CLASSIC PP-R FASER	PP-RCT UNI PP-RCT FASER COOL	PP-RCT UNI PP-RCT FASER HOT PP-RCT STABIOXY	PP-RCT HOT PP-RCT FASER HOT PP-RCT STABIOXY
		SDR 11	SDR 7,4	SDR 6	SDR 11	SDR 9	SDR 7,4
10	1	21,1	33,4	42,1	22,8	28,8	36,2
	5	19,8	31,5	39,7	22,1	27,9	35,1
	10	19,3	30,7	38,6	21,9	27,5	34,7
	25	18,7	29,7	37,4	21,5	27,1	34,1
	50	18,2	28,9	36,4	21,2	26,7	33,6
20	1	18,0	28,5	35,9	19,9	25,0	31,5
	5	16,9	26,8	33,7	19,3	24,2	30,5
	10	16,4	26,1	32,8	19,0	23,9	30,1
	25	15,9	25,2	31,7	18,6	23,5	29,6
	50	15,4	24,5	30,9	18,4	23,1	29,2
30	1	15,3	24,2	30,5	17,2	21,7	27,3
	5	14,3	22,7	28,6	16,6	20,9	26,4
	10	13,9	22,1	27,8	16,4	20,6	26,0
	25	13,4	21,3	26,8	16,1	20,2	25,5
	50	13,0	20,7	26,1	15,8	19,9	25,1
40	1	13,0	20,6	25,9	14,8	18,6	23,5
	5	12,1	19,2	24,2	14,3	18,0	22,6
	10	11,8	18,7	23,5	14,1	17,7	22,3
	25	11,3	18,0	22,6	13,8	17,3	21,8
	50	11,0	17,4	22,0	13,6	17,1	21,5
50	1	11,0	17,4	21,9	12,6	15,9	20,1
	5	10,2	16,2	20,4	12,2	15,3	19,3
	10	9,9	15,7	19,8	12,0	15,1	19,0
	25	9,5	15,1	19,0	11,7	14,7	18,6
	50	9,2	14,7	18,5	11,5	14,5	18,3
60	1	9,2	14,7	18,5	10,7	13,5	17,0
	5	8,6	13,6	17,2	10,3	13,0	16,3
	10	8,3	13,2	16,6	10,1	12,7	16,0
	25	8,0	12,7	16,0	9,9	12,4	15,7
	50	7,7	12,3	15,5	9,7	12,2	15,4
70	1	7,8	12,3	15,5	9,0	11,3	14,3
	5	7,2	11,4	14,4	8,6	10,9	13,7
	10	7,0	11,1	13,9	8,5	10,7	13,5
	25	6,0	9,6	12,1	8,3	10,4	13,1
	50	5,1	8,1	10,2	8,1	10,2	12,9

VYTÁPĚNÍ - bezpečnostní koeficient 1,5							
Teplota [°C]	Provozní doba [roky]	Maximální přípustný provozní tlak [bar]					
		PP-R CLASSIC	PP-R CLASSIC PP-R FASER	PP-R CLASSIC PP-R FASER	PP-RCT UNI PP-RCT FASER COOL PP-RCT	PP-RCT UNI PP-RCT FASER HOT PP-RCT STABIOXY	PP-RCT HOT PP-RCT FASER HOT PP-RCT STABIOXY
		SDR 11	SDR 7,4	SDR 6	SDR 11	SDR 9	SDR 7,4
30	1	12,7	20,2	25,4	14,3	18,1	22,7
	5	11,9	18,9	23,8	13,9	17,4	22,0
	10	11,6	18,4	23,2	13,6	17,2	21,7
	25	11,2	17,7	22,3	13,4	16,9	21,2
	50	10,9	17,2	21,7	13,2	16,6	20,9
40	1	10,8	17,1	21,6	12,3	15,5	19,6
	5	10,1	16,0	20,2	11,9	15,0	18,9
	10	9,8	15,5	19,6	11,7	14,7	18,6
	25	9,4	15,0	18,8	11,5	14,4	18,2
	50	9,2	14,5	18,3	11,3	14,2	17,9
50	1	9,1	14,5	18,2	10,5	13,3	16,7
	5	8,5	13,5	17,0	10,1	12,8	16,1
	10	8,2	13,1	16,5	10,0	12,6	15,8
	25	7,9	12,6	15,9	9,7	12,3	15,5
	50	7,7	12,2	15,4	9,6	12,1	15,2
60	1	7,7	12,2	15,4	8,9	11,2	14,2
	5	7,1	11,3	14,3	8,6	10,8	13,6
	10	6,9	11,0	13,9	8,4	10,6	13,4
	25	6,6	10,5	13,3	8,2	10,4	13,1
	50	6,4	10,2	12,9	8,1	10,2	12,8
70	1	6,5	10,3	12,9	7,5	9,4	11,9
	5	6,0	9,5	12,0	7,2	9,1	11,4
	10	5,8	9,2	11,6	7,0	8,9	11,2
	25	5,0	8,0	10,0	6,9	8,7	10,9
	50	4,2	6,7	8,5	6,8	8,5	10,7
80	1	5,4	8,6	10,8	6,2	7,9	9,9
	5	4,8	7,6	9,6	6,0	7,5	9,5
	10	4	6,4	8,1	5,9	7,4	9,3
	25	3,2	5,1	6,5	5,7	7,2	9,1
	95	1	3,8	6,1	7,6	4,7	5,9
5		2,6	4,1	5,2	4,4	5,6	7,1

## PP-R tlakové trubky

43 501

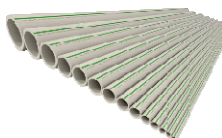

### PP-RCT UNI tlakové trubky SDR11 PN16 délka 4m

d x e mm	PN bar	m kg/m	objednací kód	cena Kč/m	cena EUR	balení [m]		sk
						MB	VB	
16 x 2,2	16	0,095	43 501 016	25,30	1,054	160		D
20 x 2,3	16	0,127	43 501 020	32,60	1,358	100		D
25 x 2,8	16	0,191	43 501 025	52,50	2,188	60		D
32 x 3,6	16	0,261	43 501 032	88,30	3,679	40		D
40 x 3,7	16	0,412	43 501 040	109,80	4,575	24		D
50 x 4,6	16	0,638	43 501 050	164,10	6,838	16		D
63 x 5,8	16	1,010	43 501 063	265,80	11,075	12		D
75 x 6,8	16	1,410	43 501 075	401,30	16,721	8		D
90 x 8,2	16	2,030	43 501 090	699,40	29,142	4		D
110 x 10,0	16	3,010	43 501 110	1 068,10	44,504	4		D

Pro aplikace do 20°C/16bar - 60°C/8bar

43 502



### PP-RCT HOT tlakové trubky SDR7,4 PN25 délka 4m

d x e mm	PN bar	m kg/m	objednací kód	cena Kč/m	cena EUR	balení [m]		sk
						MB	VB	
20 x 2,8	25	0,148	43 502 020	34,20	1,425	100		D
25 x 3,5	25	0,230	43 502 025	53,70	2,238	60		D
32 x 4,4	25	0,370	43 502 032	85,50	3,563	40		D
40 x 5,5	25	0,575	43 502 040	131,10	5,463	24		D
50 x 6,9	25	0,896	43 502 050	212,40	8,850	16		D
63 x 8,6	25	1,410	43 502 063	328,80	13,700	12		D
75 x 10,3	25	2,010	43 502 075	571,50	23,813	8		D
90 x 12,3	25	2,870	43 502 090	857,60	35,733	4		D
110 x 15,1	25	4,300	43 502 110	1 261,70	52,571	4		D

Pro aplikace do 20°C/20bar - 70°C/10bar

## PP-R tvarovky polyfuzní

43 001



koleno 90°

d mm	PN bar	m kg	objednáací kód	cena Kč	cena EUR	balení [ks]		sk
						MB	VB	
16	20	0,012	43 001 016	6,40	0,27	80	480	D
20	20	0,015	43 001 020	4,80	0,20	80	480	D
25	20	0,023	43 001 025	7,80	0,33	40	320	D
32	20	0,043	43 001 032	12,60	0,53	28	168	D
40	20	0,068	43 001 040	23,50	0,98	12	84	D
50	20	0,130	43 001 050	47,20	1,97	9	54	D
63	20	0,259	43 001 063	75,90	3,16	4	24	D
75	20	0,499	43 001 075	210,40	8,77	4	16	D
90	20	0,620	43 001 090	310,40	12,93	1	8	D
110	20	1,055	43 001 110	575,20	23,97	1	3	D

43 002



koleno 90° vnitřní x vnější

d mm	PN bar	m kg	objednáací kód	cena Kč	cena EUR	balení [ks]		sk
						MB	VB	
20	20	0,010	43 002 020	6,20	0,26	80	480	D
25	20	0,030	43 002 025	9,70	0,40	40	320	D
32	20	0,080	43 002 032	29,40	1,23	28	168	D

43 004



koleno 90° s kovovým závitem vnitřním

d x G mm x inch	PN bar	m kg	objednáací kód	cena Kč	cena EUR	balení [ks]		sk
						MB	VB	
d16 x 1/2"	20	0,050	43 004 016 012	70,70	2,95	20	200	D
d20 x 1/2"	20	0,050	43 004 020 012	49,20	2,05	20	200	D
d20 x 3/4"	20	0,075	43 004 020 034	65,80	2,74	15	150	D
d25 x 1/2"	20	0,051	43 004 025 012	52,10	2,17	15	180	D
d25 x 3/4"	20	0,070	43 004 025 034	65,50	2,73	15	150	D
d32 x 1"	20	0,131	43 004 032 100	122,60	5,11	8	80	D

43 005



koleno 90° s kovovým závitem vnějším

d x G mm x inch	PN bar	m kg	objednáací kód	cena Kč	cena EUR	balení [ks]		sk
						MB	VB	
d16 x 1/2"	20	0,057	43 005 016 012	75,20	3,13	20	200	D
d20 x 1/2"	20	0,057	43 005 020 012	51,30	2,14	20	200	D
d20 x 3/4"	20	0,064	43 005 020 034	75,90	3,16	15	150	D
d25 x 1/2"	20	0,075	43 005 025 012	55,50	2,31	15	150	D
d25 x 3/4"	20	0,080	43 005 025 034	76,70	3,20	15	150	D
d32 x 1"	20	0,157	43 005 032 100	153,30	6,39	8	72	D

43 008



koleno 90° nástěnné

d x G mm x inch	PN bar	m kg	objednáací kód	cena Kč	cena EUR	balení [ks]		sk
						MB	VB	
d16 x 1/2"	20	0,070	43 008 016 012	60,40	2,52	15	180	D
d20 x 1/2"	20	0,080	43 008 020 012	40,80	1,70	15	180	D
d25 x 1/2"	20	0,080	43 008 025 012	51,30	2,14	15	150	D
d25 x 3/4"	20	0,090	43 008 025 034	72,10	3,00	15	150	D

43 020



oblouk 90°

d mm	PN bar	m kg	objednáací kód	cena Kč	cena EUR	balení [ks]		sk
						MB	VB	
20	20	0,024	43 020 020	14,20	0,59	1	125	D
25	20	0,049	43 020 025	17,20	0,72	1	100	D
32	20	0,100	43 020 032	33,20	1,38	1	50	D
40	20	0,193	43 020 040	61,60	2,57	1	25	D



43 011

koleno 45°



d mm	PN bar	m kg	objednáací kód	cena Kč	cena EUR	balení [ks]		sk
						MB	VB	
16	20	0,014	43 011 016	11,30	0,47	80	560	D
20	20	0,014	43 011 020	5,60	0,23	80	560	D
25	20	0,021	43 011 025	7,70	0,32	45	360	D
32	20	0,039	43 011 032	14,50	0,60	12	180	D
40	20	0,055	43 011 040	22,70	0,95	12	72	D
50	20	0,113	43 011 050	42,80	1,78	8	64	D
63	20	0,191	43 011 063	65,20	2,72	5	30	D
75	20	0,283	43 011 075	247,60	10,32	4	16	D
90	20	0,460	43 011 090	375,60	15,65	4	12	D
110	20	0,770	43 011 110	521,30	21,72	1	6	D

43 012

koleno 45° vnitřní x vnější



d mm	PN bar	m kg	objednáací kód	cena Kč	cena EUR	balení [ks]		sk
						MB	VB	
16	20	0,010	43 012 016	15,00	0,63	80	560	D
20	20	0,020	43 012 020	5,90	0,25	80	560	D
25	20	0,010	43 012 025	11,90	0,50	80	560	D

43 040

T-kus 90°



d mm	PN bar	m kg	objednáací kód	cena Kč	cena EUR	balení [ks]		sk
						MB	VB	
16	20	0,020	43 040 016	14,10	0,59	45	360	D
20	20	0,017	43 040 020	6,50	0,27	45	360	D
25	20	0,031	43 040 025	9,90	0,41	30	210	D
32	20	0,052	43 040 032	20,40	0,85	20	120	D
40	20	0,081	43 040 040	38,60	1,61	8	64	D
50	20	0,149	43 040 050	59,10	2,46	6	36	D
63	20	0,306	43 040 063	88,00	3,67	4	24	D
75	20	0,471	43 040 075	288,90	12,04	1	13	D
90	20	0,778	43 040 090	491,30	20,47	1	6	D
110	20	1,400	43 040 110	687,30	28,64	1	3	D

43 041

T-kus 90° redukovaný



d x d x d mm	PN bar	m kg	objednáací kód	cena Kč	cena EUR	balení [ks]		sk
						MB	VB	
20 x 16 x 20	20	0,030	43 041 020 016	16,80	0,70	45	360	D
25 x 20 x 25	20	0,026	43 041 025 020	9,40	0,39	35	245	D
32 x 20 x 32	20	0,037	43 041 032 020	18,30	0,76	28	168	D
32 x 25 x 32	20	0,043	43 041 032 025	19,20	0,80	26	156	D
40 x 20 x 40	20	0,063	43 041 040 020	29,30	1,22	12	72	D
40 x 25 x 40	20	0,065	43 041 040 025	33,00	1,38	12	72	D
40 x 32 x 40	20	0,075	43 041 040 032	37,10	1,55	12	72	D
50 x 25 x 50	20	0,098	43 041 050 025	49,50	2,06	9	54	D
50 x 32 x 50	20	0,112	43 041 050 032	49,50	2,06	6	48	D
50 x 40 x 50	20	0,126	43 041 050 040	60,50	2,52	6	48	D
63 x 25 x 63	20	0,162	43 041 063 025	235,80	9,83	6	24	D
63 x 32 x 63	20	0,180	43 041 063 032	97,50	4,06	6	24	D
63 x 40 x 63	20	0,218	43 041 063 040	97,50	4,06	6	24	D
63 x 50 x 63	20	0,242	43 041 063 050	97,50	4,06	6	24	D
75 x 32 x 75	20		43 041 075 032	190,60	7,94	6	24	E
75 x 50 x 75	20	0,348	43 041 075 050	449,20	18,72	4	16	D
75 x 63 x 75	20	0,420	43 041 075 063	467,60	19,48	4	16	D
90 x 63 x 90	20	0,610	43 041 090 063	639,30	26,64	2	12	D
90 x 75 x 90	20	0,681	43 041 090 075	639,30	26,64	1	6	D
110 x 63 x 110	20	0,873	43 041 110 063	1 072,10	44,67	1	4	D
110 x 75 x 110	20	0,919	43 041 110 075	1 080,70	45,03	1	4	D
110 x 90 x 110	20	1,112	43 041 110 090	1 098,10	45,75	1	4	D

43 043



T-kus 90° plastový s převlečnou maticí

d x G x d mm x inch x mm	PN bar	m kg	objednáací kód	cena Kč	cena EUR	balení [ks]		sk
						MB	VB	
20 x 3/4" x 20	20	0,070	43 043 020 034	57,00	2,38	10	120	D
25 x 3/4" x 25	20	0,080	43 045 025 034	81,90	3,41	10	100	D
25 x 1" x 25	20	0,090	43 043 025 100	94,00	3,92	10	60	D
32 x 3/4" x 32	20	0,090	43 043 032 034	72,40	3,02	10	50	D
32 x 1" x 32	20	0,137	43 043 032 100	102,30	4,26	10	50	D

43 044



T-kus 90° s kovovým závitem vnitřním

d x G x d mm x inch x mm	PN bar	m kg	objednáací kód	cena Kč	cena EUR	balení [ks]		sk
						MB	VB	
20 x 1/2" x 20	20	0,048	43 044 020 012	46,10	1,92	20	200	D
25 x 1/2" x 25	20	0,057	43 044 025 012	48,80	2,03	15	150	D
25 x 3/4" x 25	20	0,074	43 044 025 034	74,50	3,10	15	150	D
32 x 3/4" x 32	20	0,098	43 044 032 034	159,20	6,63	8	96	D
32 x 1" x 32	20	0,138	43 044 032 100	138,00	5,75	8	72	D

43 045



T-kus 90° s kovovým závitem vnější

d x G x d mm x inch x mm	PN bar	m kg	objednáací kód	cena Kč	cena EUR	balení [ks]		sk
						MB	VB	
20 x 1/2" x 20	20	0,060	43 045 020 012	57,30	2,39	15	180	D
25 x 1/2" x 25	20	0,690	43 045 025 012	59,30	2,47	12	144	D
25 x 3/4" x 25	20	0,090	43 045 025 034	81,90	3,41	10	140	D
32 x 1" x 32	20	0,190	43 045 032 100	191,30	7,97	8	56	D

43 048



kříž

d mm	PN bar	m kg	objednáací kód	cena Kč	cena EUR	balení [ks]		sk
						MB	VB	
20	20	0,017	43 048 020	13,30	0,55	25	100	D
25	20	0,031	43 048 025	19,50	0,81	15	75	D
32	20	0,052	43 048 032	33,30	1,39	10	50	D

43 049



průchozí nástěnka

d x G x d mm x inch x mm	PN bar	m kg	objednáací kód	cena Kč	cena EUR	balení [ks]		sk
						MB	VB	
20 x 1/2" x 20	20	0,080	43 049 020 012	56,40	2,35	6	120	D
25 x 1/2" x 25	20		43 049 025 012	98,10	4,09			D

43 050



univerzální nástěnný komplet

d x G mm x inch	PN bar	m kg	objednáací kód	cena Kč	cena EUR	balení [ks]		sk
						MB	VB	
2 x 20 x 1/2"	20	0,080	43 050 020 012	154,40	6,43	10	100	D
2 x 25 x 1/2"	20		43 050 025 012	340,70	14,20			D

43 060



spojka

d mm	PN bar	m kg	objednáací kód	cena Kč	cena EUR	balení [ks]		sk
						MB	VB	
16	20	0,010	43 060 016	9,20	0,38	100	800	D
20	20	0,009	43 060 020	4,10	0,17	100	800	D
25	20	0,016	43 060 025	6,20	0,26	60	480	D
32	20	0,024	43 060 032	9,80	0,41	42	252	D
40	20	0,037	43 060 040	16,80	0,70	20	160	D
50	20	0,069	43 060 050	28,50	1,19	12	96	D
63	20	0,124	43 060 063	45,40	1,89	8	56	D
75	20	0,210	43 060 075	188,90	7,87	8	32	D
90	20	0,325	43 060 090	200,80	8,37	2	20	D
110	20	0,491	43 060 110	321,40	13,39	1	10	D

43 061



elektrospojka

d mm	PN bar	m kg	objednací kód	cena Kč	cena EUR	balení [ks]		sk
						MB	VB	
20	20		43 061 020	271,20	11,30	1	50	D
25	20	0,075	43 061 025	348,40	14,52	1	50	D
32	20	0,097	43 061 032	358,80	14,95	1	40	D
40	20	0,127	43 061 040	379,50	15,81	1	40	D
50	20	0,210	43 061 050	462,50	19,27	1	1	D
63	20	0,320	43 061 063	586,90	24,45	1	1	D
75	20	0,487	43 061 075	723,80	30,16	1	12	D
90	20	0,565	43 061 090	932,20	38,84	1	10	D
110	20		43 061 110	1 294,10	53,92	1	8	D

43 062



redukce vnitřní x vnitřní

d x d mm	PN bar	m kg	objednací kód	cena Kč	cena EUR	balení [ks]		sk
						MB	VB	
20 x 16	20	0,010	43 062 020 016	12,20	0,51	100	600	D
25 x 20	20	0,013	43 062 025 020	5,90	0,25	80	560	D
32 x 20	20	0,019	43 062 032 020	7,80	0,33	55	385	D
32 x 25	20	0,023	43 062 032 025	9,00	0,38	50	350	D
40 x 20	20	0,028	43 062 040 020	10,60	0,44	40	240	D
40 x 25	20	0,030	43 062 040 025	11,30	0,47	40	240	D
40 x 32	20	0,031	43 062 040 032	16,60	0,69	25	200	D
50 x 20	20	0,045	43 062 050 020	19,80	0,83	21	168	D
50 x 25	20	0,045	43 062 050 025	23,80	0,99	21	168	D
50 x 32	20	0,049	43 062 050 032	23,10	0,96	21	168	D
50 x 40	20	0,055	43 062 050 040	25,90	1,08	12	108	D
63 x 50	20	0,108	43 062 063 050	90,40	3,77	9	54	D

43 063



redukce vnější x vnitřní

d x d mm	PN bar	m kg	objednací kód	cena Kč	cena EUR	balení [ks]		sk
						MB	VB	
20 x 16	20	0,010	43 063 020 016	9,30	0,39	100	600	D
25 x 20	20	0,020	43 063 025 020	5,30	0,22	50	500	D
32 x 20	20	0,030	43 063 032 020	8,40	0,35	30	300	D
32 x 25	20	0,030	43 063 032 025	8,10	0,34	30	300	D
40 x 20	20	0,030	43 063 040 020	18,90	0,79	20	200	D
40 x 25	20	0,020	43 063 040 025	17,50	0,73	20	200	D
40 x 32	20	0,030	43 063 040 032	17,80	0,74	20	160	D
50 x 32	20	0,040	43 063 050 032	33,10	1,38	10	100	D
50 x 40	20	0,050	43 063 050 040	34,90	1,45	10	100	D
63 x 32	20	0,070	43 063 063 032	71,20	2,97	5	60	D
63 x 40	20	0,080	43 063 063 040	74,40	3,10	5	60	D
63 x 50	20	0,120	43 063 063 050	86,60	3,61	5	60	D
75 x 40	20		43 063 075 040	186,40	7,77			D
75 x 50	20		43 063 075 050	156,30	6,51	4	40	D
75 x 63	20	0,210	43 063 075 063	156,30	6,51	4	40	D
90 x 63	20	0,240	43 063 090 063	168,50	7,02	2	16	D
90 x 75	20	0,270	43 063 090 075	174,00	7,25	2	16	D
110 x 75	20	1,100	43 063 110 075	309,70	12,90	1	12	D
110 x 90	20	1,100	43 063 110 090	262,60	10,94	1	12	D

43 072



**přechod vnitřní x kovový závit vnitřní**

d x G mm x inch	PN bar	m kg	objednací kód	cena Kč	cena EUR	balení [ks]		sk
						MB	VB	
16 x 1/2"	20	0,060	43 072 016 012	60,70	2,53	32	320	D
20 x 1/2"	20	0,050	43 072 020 012	35,80	1,49	32	320	D
20 x 3/4"	20	0,060	43 072 020 034	48,10	2,00	30	300	D
25 x 1/2"	20	0,050	43 072 025 012	43,10	1,80	20	300	D
25 x 3/4"	20	0,060	43 072 025 034	50,80	2,12	20	260	D
32 x 3/4"	20	0,080	43 072 032 034	186,60	7,78	12	180	D
32 x 1"	20	0,110	43 072 032 100	101,40	4,23	12	144	D
40 x 1 1/4"	20	0,160	43 072 040 114	220,70	9,20	10	70	D
50 x 1 1/2"	20	0,240	43 072 050 112	319,30	13,30	9	45	D
63 x 2"	20	0,370	43 072 063 200	473,60	19,73	4	36	D

43 073



**přechod plastový vnější x převlečná matice**

d x G mm x inch	PN bar	m kg	objednací kód	cena Kč	cena EUR	balení [ks]		sk
						MB	VB	
20 x 3/4"	20	0,040	43 073 020 034	44,50	1,85	50	700	D
25 x 1"	20	0,070	43 073 025 100	78,00	3,25	25	400	D
32 x 1 1/4"	20	0,100	43 073 032 114	121,80	5,08	25	250	D

43 074



**plastová spojka s převlečnou matkou**

d x G mm x inch	PN bar	m kg	objednací kód	cena Kč	cena EUR	balení [ks]		sk
						MB	VB	
20 x 1/2"	20	0,190	43 074 020 012	31,50	1,15	15	150	B
20 x 3/4"	20	0,270	43 074 020 034	38,30	1,39	10	100	B
25 x 3/4"	20	0,490	43 074 025 034	40,90	1,49	8		B

43 076



**přechod vnitřní x kovová převlečná matice**

d x G mm x inch	PN bar	m kg	objednací kód	cena Kč	cena EUR	balení [ks]		sk
						MB	VB	
16 x 1/2"	20	0,050	43 076 016 012	109,50	4,56	50		D
20 x 1/2"	20	0,050	43 076 020 012	111,60	4,65	50		D
20 x 3/4"	20	0,080	43 076 020 034	129,50	5,40	50		D
20 x 1"	20	0,240	43 076 020 100	262,00	10,92	50		D
25 x 3/4"	20	0,150	43 076 025 034	171,60	7,15			D
25 x 1"	20	0,240	43 076 025 100	273,40	11,39	30		D
32 x 1 1/4"	20	0,350	43 076 032 114	451,70	18,82			D

43 077



**přechod vnitřní x kovový závit vnější**

d x G mm x inch	PN bar	m kg	objednací kód	cena Kč	cena EUR	balení [ks]		sk
						MB	VB	
16 x 1/2"	20	0,090	43 077 016 012	71,00	2,96	10	300	D
20 x 1/2"	20	0,050	43 077 020 012	42,00	1,75	25	300	D
20 x 3/4"	20	0,060	43 077 020 034	62,00	2,58	20	240	D
25 x 1/2"	20	0,500	43 077 025 012	47,30	1,97	20	280	D
25 x 3/4"	20	0,070	43 077 025 034	63,20	2,63	15	210	D
32 x 3/4"	20	0,080	43 077 032 034	207,40	8,64	10	150	D
32 x 1"	20	0,130	43 077 032 100	120,90	5,04	10	120	D
40 x 1 1/4"	20	0,200	43 077 040 114	263,60	10,98	10	50	D
50 x 1 1/2"	20	0,250	43 077 050 112	328,60	13,69	9	45	D
63 x 2"	20	0,410	43 077 063 200	453,60	18,90	4	36	D
75 x 2 1/2"	20	1,110	43 077 075 212	1 325,60	55,23	1	12	D
90 x 3"	20	1,640	43 077 090 300	1 977,50	82,40	1	8	D

43 078



přechod vnitřní x plastový závit vnější

d x G mm x inch	PN bar	m kg	objednáací kód	cena Kč	cena EUR	balení [ks]		sk
						MB	VB	
20 x 1/2"	10	0,010	43 078 020 012	13,30	0,55	10	300	D
20 x 3/4"	10	0,020	43 078 020 034	16,70	0,70	10	33	D
25 x 3/4"	10	0,020	43 078 025 034	25,50	1,06	10	210	D
32 x 1"	10	0,030	43 078 032 100	35,50	1,48	10	120	D
40 x 1 1/4"	10	0,070	43 078 040 114	64,30	2,68	5	50	D
50 x 1 1/2"	10	0,120	43 078 050 112	108,50	4,52	9	45	D
63 x 2"	10	0,220	43 078 063 200	187,30	7,80	4	36	D

43 105



víčko

d mm	PN bar	m kg	objednáací kód	cena Kč	cena EUR	balení [ks]		sk
						MB	VB	
16	20	0,006	43 105 016	11,30	0,47	135	1080	D
20	20	0,006	43 105 020	3,90	0,16	135	1080	D
25	20	0,010	43 105 025	6,20	0,26	100	800	D
32	20	0,016	43 105 032	7,20	0,30	50	450	D
40	20	0,030	43 105 040	14,90	0,62	50	200	D
50	20	0,061	43 105 050	41,10	1,71	16	144	D
63	20	0,106	43 105 063	57,80	2,41	15	90	D
75	20	0,194	43 105 075	212,70	8,86	10	40	D
90	20	0,283	43 105 090	244,70	10,20	10	30	D
110	20	0,508	43 105 110	326,30	13,60	5	15	D

43 110



rozebiratelný spoj

d / G mm / inch	PN bar	m kg	objednáací kód	cena Kč	cena EUR	balení [ks]		sk
						MB	VB	
d20 / G3/4"	20	0,080	43 110 020	115,90	4,83	20	240	D
d25 / G1"	20	0,120	43 110 025	177,40	7,39	15	210	D
d32 / G5/4"	20	0,190	43 110 032	247,30	10,30	10	150	D
d40 / G6/4"	20	0,120	43 110 040	389,50	16,23	15	210	D
d50 / G2"	20	0,190	43 110 050	674,40	28,10	10	150	D

43 114



šroubení s mosazným vnitřním závitem

d x G mm x inch	PN bar	m kg	objednáací kód	cena Kč	cena EUR	balení [ks]		sk
						MB	VB	
20 x 1/2"	20	0,160	43 114 020 012	113,90	4,75	20	200	D
25 x 3/4"	20	0,270	43 114 025 034	178,90	7,45	15	150	D
32 x 1"	20	0,490	43 114 032 100	249,80	10,41	10	100	D
40 x 1 1/4"	20	0,800	43 114 040 114	344,50	14,35	10	60	D
50 x 1 1/2"	20	0,900	43 114 050 112	528,50	22,02	4	40	D
63 x 2"	20	1,100	43 114 063 200	1 153,40	48,06	2	20	D

43 115



šroubení s mosazným vnějším závitem

d x G mm x inch	PN bar	m kg	objednáací kód	cena Kč	cena EUR	balení [ks]		sk
						MB	VB	
20 x 1/2"	20	0,190	43 115 020 012	113,90	4,75	15	150	D
25 x 3/4"	20	0,270	43 115 025 034	179,30	7,47	10	100	D
32 x 1"	20	0,490	43 115 032 100	256,50	10,69	8		D
40 x 1 1/4"	20	0,800	43 115 040 114	428,70	17,86	8	56	D
50 x 1 1/2"	20	0,900	43 115 050 112	602,80	16,38	4	40	D
63 x 2"	20	1,100	43 115 063 200	1 233,80	51,41	2	20	D

43 150



lemový nákrůžek polyfuzní vnější

d/DN mm x inch	PN bar	m kg	objednáací kód	cena Kč	cena EUR	balení [ks]		sk
						MB	VB	
d40/DN32	20	0,070	43 150 040	49,40	2,06	4	40	D
d50/DN40	20	0,100	43 150 050	58,50	2,44	2	40	D
d63/DN50	20	0,150	43 150 063	94,20	3,93	2	20	D
d75/DN65	20	0,260	43 150 075	154,50	6,44	1	15	D
d90/DN80	20	0,370	43 150 090	206,70	16,38	1	10	D
d110/DN100	20	0,620	43 150 110	272,50	11,35	1	5	D

43 160



příruba litinová

d/DN mm x inch	PN bar	m kg	objednáací kód	cena Kč	cena EUR	balení [ks]		sk
						MB	VB	
d40/DN32 PN16		1,420	43 160 040	542,90	22,62	1	1	D
d50/DN40 PN16		1,820	43 160 050	551,50	22,98	1	1	D
d63/DN50 PN16		2,230	43 160 063	618,70	25,78	1	1	D
d75/DN65 PN16		2,480	43 160 075	865,30	36,05	1	1	D
d90/DN80 PN16		3,250	43 160 090	942,80	16,38	1	1	D
d110/DN100 PN16		3,600	43 160 110	1 168,20	48,68	1	1	D

43 180



křížení trubkové

d mm	PN bar	m kg	objednáací kód	cena Kč	cena EUR	balení [ks]		sk
						MB	VB	
16	20	0,030	43 180 016	37,40	1,56	25	125	D
20	20	0,070	43 180 020	30,00	1,25	25	125	D
25	20	0,090	43 180 025	37,40	1,56	20	80	D
32	20	0,160	43 180 032	53,80	2,24	15	60	D
40	20	0,330	43 180 040	122,80	5,12	5	20	D

43 182



křížení hrdlové krátké

d mm	PN bar	m kg	objednáací kód	cena Kč	cena EUR	balení [ks]		sk
						MB	VB	
20	20	0,070	43 182 020	28,30	1,18	1	160	D
25	20	0,090	43 182 025	33,20	1,38	1	100	D

43 181



kompenzační smyčka

d mm	PN bar	m kg	objednáací kód	cena Kč	cena EUR	balení [ks]		sk
						MB	VB	
16	20	0,070	43 181 016	46,90	1,95	10	40	D
20	20	0,110	43 181 020	89,10	3,71	5	20	D
25	20	0,210	43 181 025	118,60	4,94	5	10	D
32	20	0,430	43 181 032	190,20	7,93	2	8	D
40	20	0,670	43 181 040	265,80	11,08	1	7	D

43 300



kulový kohout plastový s mosaznou koulí

d mm	PN bar	m kg	objednáací kód	cena Kč	cena EUR	balení [ks]		sk
						MB	VB	
16	20		43 300 016	191,90	8,00			D
20	20	0,090	43 300 020	112,30	4,68	2	70	D
25	20	0,110	43 300 025	143,70	5,99	2	70	D
32	20	0,181	43 300 032	205,90	8,58	2	50	D
40	20	0,280	43 300 040	368,10	15,34	1	36	D
50	20	0,534	43 300 050	582,90	24,29	1	18	D
63	20	0,893	43 300 063	853,60	35,57	1	14	D
75	20	1,830	43 300 075	1 974,80	82,28	1	6	D

43 302



kulový kohout mosazný niklovaný 2x šroubení

d mm	PN bar	m kg	objednáací kód	cena Kč	cena EUR	balení [ks]		sk
						MB	VB	
25	20	0,249	43 302 025	374,60	15,61	10	100	D
32	20	0,377	43 302 032	627,90	26,16	8	80	D

43 350



ventil přímý plastový

d mm	PN bar	m kg	objednáací kód	cena Kč	cena EUR	balení [ks]		sk
						MB	VB	
20	20	0,150	43 350 020	165,30	6,89	5	70	D
25	20	0,093	43 350 025	228,20	9,51	5	70	D
32	20	0,111	43 350 032	283,90	11,83	5	50	D
40	20	0,400	43 350 040	465,00	19,38	4	36	D
50	20	0,770	43 350 050	671,40	27,98	2	18	D
63	20	1,290	43 350 063	897,10	37,38	1	15	D

## Příslušenství

### PP Camlock



- polypropylén zpevněný skelným vláknem
- nerezové uzavírací páky
- EPDM těsnění

#### 50 001 A

#### adaptér s vnitřním závitem



tělo inch	G inch	PN bar	m kg	objednací kód	cena Kč	cena EUR	balení [ks]		sk
							MB	VB	
3/4"	1/2"	9		50 001 03A2	92,70	3,863			E
3/4"	3/4"	9		50 001 03A	95,50	3,979			E
1"	1"	9		50 001 04A	68,00	2,833			E
5/4"	5/4"	9		50 001 05A	103,40	4,308			E
6/4"	5/4"	9		50 001 06A5	119,50	4,979			E
6/4"	6/4"	9		50 001 06A	103,70	4,321			E
2"	2"	9		50 001 07A	108,00	4,500			E
3"	2 1/2"	5		50 001 09A8	276,30	11,513			E
3"	3"	5		50 001 09A	253,90	10,579			E
4"	4"	5		50 001 0AA	474,10	19,754			E

#### 50 001 B

#### rychlospojka s vnějším závitem



tělo inch	G inch	PN bar	m kg	objednací kód	cena Kč	cena EUR	balení [ks]		sk
							MB	VB	
3/4"	1/2"	9		50 001 03B2	222,40	9,267			E
3/4"	3/4"	9		50 001 03B	144,00	6,000			E
1"	1"	9		50 001 04B	265,00	11,042			E
5/4"	5/4"	9		50 001 05B	299,00	12,458			E
6/4"	5/4"	9		50 001 06B5	362,10	15,088			E
6/4"	6/4"	9		50 001 06B	310,90	12,954			E
2"	2"	9		50 001 07B	416,00	17,333			E
3"	2 1/2"	5		50 001 09B8	593,60	24,733			E
3"	3"	5		50 001 09B	634,70	26,446			E
4"	4"	5		50 001 0AB	1 198,40	49,933			E

#### 50 001 C

#### rychlospojka s hadicovým trnem



tělo inch	d mm	PN bar	m kg	objednací kód	cena Kč	cena EUR	balení [ks]		sk
							MB	VB	
3/4"	13	9		50 001 03C2	246,40	10,267			E
3/4"	19	9		50 001 03C	160,60	6,692			E
1"	25	9		50 001 04C	250,30	10,429			E
1"	32	9		50 001 04C5	298,70	12,446			E
5/4"	30	9		50 001 05C30	343,50	14,313			E
5/4"	32	9		50 001 05C	276,30	11,513			E
6/4"	32	9		50 001 06C5	362,10	15,088			E
6/4"	38	9		50 001 06C	303,30	12,638			E
6/4"	40	9		50 001 06C40	311,10	12,963			E
2"	50	9		50 001 07C	318,00	13,250			E
2"	53	9		50 001 07C53	451,70	18,821			E
3"	60	5		50 001 09C60	591,70	24,654			E
3"	63	5		50 001 09C8	686,90	28,621			E
3"	75	5		50 001 09C	589,90	24,579			E
3"	78	5		50 001 09C78	686,90	28,621			E
3"	87	5		50 001 09C87	686,90	28,621			E
4"	105	5		50 001 0AC105	1 198,40	49,933			E

#### 50 001 D

#### rychlospojka s vnitřním závitem



tělo inch	G inch	PN bar	m kg	objednací kód	cena Kč	cena EUR	balení [ks]		sk
							MB	VB	
3/4"	1/2"	9		50 001 03D2	246,40	10,267			E
3/4"	3/4"	9		50 001 03D	224,10	9,338			E
1"	1"	9		50 001 04D	276,00	11,500			E
5/4"	5/4"	9		50 001 05D	348,00	14,500			E
6/4"	5/4"	9		50 001 06D5	290,50	12,104			E
6/4"	6/4"	9		50 001 06D	290,00	12,083			E
2"	2"	9		50 001 07D	308,00	12,833			E
3"	2 1/2"	5		50 001 09D8	658,80	27,450			E
3"	3"	5		50 001 09D	510,00	21,250			E
4"	4"	5		50 001 0AD	1 198,40	49,933			E

50 001 E

adaptér s hadicovým trnem



tělo inch	d mm	PN bar	m kg	objednáací kód	cena Kč	cena EUR	balení [ks]		sk
							MB	VB	
3/4"	13	9		50 001 03E2	95,90	3,996			E
3/4"	19	9		50 001 03E	100,30	4,179			E
1"	25	9		50 001 04E	99,00	4,125			E
1"	32	9		50 001 04E5	104,50	4,354			E
5/4"	30	9		50 001 05E30	104,50	4,354			E
5/4"	32	9		50 001 05E	80,90	3,371			E
6/4"	32	9		50 001 06E5	119,50	4,979			E
6/4"	38	9		50 001 06E	101,20	4,217			E
6/4"	40	9		50 001 06E40	103,90	4,329			E
2"	50	9		50 001 07E	137,90	5,746			E
2"	53	9		50 001 07E53	149,30	6,221			E
2"	55	9		50 001 07E55	130,90	5,454			E
3"	60	5		50 001 09E60	274,50	11,438			E
3"	63	5		50 001 09E8	298,70	12,446			E
3"	75	5		50 001 09E	276,30	11,513			E
3"	78	5		50 001 09E78	298,70	12,446			E
3"	87	5		50 001 09E87	298,70	12,446			E
4"	105	5		50 001 0AE105	474,10	19,754			E

50 001 F

adaptér s vnějším závitem



tělo inch	G inch	PN bar	m kg	objednáací kód	cena Kč	cena EUR	balení [ks]		sk
							MB	VB	
3/4"	1/2"	9		50 001 03F2	104,50	4,354			E
3/4"	3/4"	9		50 001 03F	57,10	2,379			E
1"	1"	9		50 001 04F	87,80	3,658			E
5/4"	5/4"	9		50 001 05F	88,10	3,671			E
6/4"	5/4"	9		50 001 06F5	119,50	4,979			E
6/4"	6/4"	9		50 001 06F	103,70	4,321			E
2"	2"	9		50 001 07F	137,70	5,738			E
3"	2 1/2"	5		50 001 09F8	251,50	10,479			E
3"	3"	5		50 001 09F	276,30	11,513			E
4"	4"	5		50 001 0AF	474,10	19,754			E

50 001 G

zátká rychlospojky



tělo inch		PN bar	m kg	objednáací kód	cena Kč	cena EUR	balení [ks]		sk
							MB	VB	
3/4"		9		50 001 03G	95,90	3,996			E
1"		9		50 001 04G	100,30	4,179			E
5/4"		9		50 001 05G	100,30	4,179			E
6/4"		9		50 001 06G	115,50	4,813			E
2"		9		50 001 07G	112,60	4,692			E
3"		5		50 001 09G	240,90	10,038			E
4"		5		50 001 0AG	373,30	15,554			E

50 001 H

víčko na adaptér



tělo inch		PN bar	m kg	objednáací kód	cena Kč	cena EUR	balení [ks]		sk
							MB	VB	
3/4"		9		50 001 03H	224,40	9,350			E
1"		9		50 001 04H	286,00	11,917			E
5/4"		9		50 001 05H	317,70	13,238			E
6/4"		9		50 001 06H	303,20	12,633			E
2"		9		50 001 07H	416,10	17,338			E
3"		5		50 001 09H	487,00	20,292			E
4"		5		50 001 0AH	1 037,90	43,246			E

50 001 S

adaptér k IBC kontejneru



tělo inch		PN bar	m kg	objednáací kód	cena Kč	cena EUR	balení [ks]		sk
							MB	VB	
2"	S60x6 vnitřní			50 001 07S	106,50	4,438			E



## Příslušenství

50 001

### pojistná spona



tělo inch	PN bar	m kg	objednáací kód	cena Kč	cena EUR	balení [ks]		sk
						MB	VB	
3/4"			50 001 030	93,30	3,888			E
1"			50 001 040	93,30	3,888			E
5/4"			50 001 050	100,80	4,200			E
6/4"			50 001 060	86,10	3,588			E
2"			50 001 070	171,70	7,154			E
3"			50 001 090	175,50	7,313			E

50 003

### přechod k IBC kontejneru



	PN bar	m kg	objednáací kód	cena Kč	cena EUR	balení [ks]		sk
						MB	VB	
(S60x6) x G1" vnitřní			50 003 013	228,60	9,525			Z
(S60x6) x G6/4" vnitřní			50 003 015	110,00	4,583			D

35 525

### PP příchytky



typ B



typ C

d mm	typ	m kg	objednáací kód	cena Kč	cena EUR	balení [ks]		sk
						MB	VB	
12	B		35 525 012	10,30	0,429	10	500	E
16	B		35 525 016	12,40	0,517	10	400	E
20	B		35 525 020	14,40	0,600	10	400	E
25	B		35 525 025	17,50	0,729	10	800	E
32	B		35 525 032	20,60	0,858	10	600	E
32	C		35 525 033	26,80	1,117	10	400	E
40	C		35 525 040	30,90	1,288	10	250	E
50	C		35 525 050	34,00	1,417	10	250	E
63	C		35 525 063	47,40	1,975	10	150	E
75	C		35 525 075	80,30	3,346	10	80	E
90	C		35 525 090	103,00	4,292	10	60	E
11	C		35 525 110	119,40	4,975	10	50	E
125	C		35 525 125	175,00	7,292	10	40	E
140	C		35 525 140	201,00	8,375	10	20	E
160	C		35 525 160	228,60	9,525	10	20	E

35 524

### PP distanční podložka



d mm	PN bar	m kg	objednáací kód	cena Kč	cena EUR	balení [ks]		sk
						MB	VB	
16			35 524 016	7,50	0,313	10	400	E
20			35 524 020	8,20	0,342	10	400	E
25			35 524 025	9,30	0,388	10	800	E
32			35 524 032	10,30	0,429	10	600	E
32			35 524 033	14,40	0,600	10	400	E
40			35 524 040	15,50	0,646	10	250	E
50			35 524 050	17,50	0,729	10	250	E
63			35 524 063	23,70	0,988	10	150	E
75			35 524 075	40,20	1,675	10	80	E
90			35 524 090	41,20	1,717	10	100	E
110			35 524 110	52,20	2,175	10	80	E
125			35 524 125	70,00	2,917	10	150	E
140			35 524 140	78,30	3,263	10	140	E
160			35 524 160	90,60	3,775	10	120	E

## Příslušenství

### 35 526



### PP příchytky

d mm	PN bar	m kg	objednáací kód	cena Kč	cena EUR	balení [ks]		sk
						MB	VB	
90			35 526 090	194,40	8,100		60	E
110			35 526 110	144,90	6,038		40	E
125			35 526 125	197,40	8,225		40	E
140			35 526 140	239,40	9,975		40	E
160			35 526 160	273,00	11,375		20	E
180			35 526 180	315,00	13,125		20	E
200			35 526 200	372,70	15,529		10	E
225			35 526 225	434,50	18,104		10	E
250			35 526 250	551,80	22,992		10	E
280			35 526 280	642,40	26,767		10	E
315			35 526 315	704,20	29,342		10	E
355			35 526 355	947,10	39,463		10	E
400			35 526 400	1 024,80	42,700		10	E

### 35 521



### PP příchytky s třmenem

d mm	PN bar	m kg	objednáací kód	cena Kč	cena EUR	balení [ks]		sk
						MB	VB	
20			35 521 020	5,73	0,239	50	500	D
25			35 521 025	6,29	0,262	50	500	D
32			35 521 032	6,71	0,280	50	500	D
40			35 521 040	8,66	0,361	50	500	D
50			35 521 050	13,42	0,559	25	100	D
63			35 521 063	15,72	0,655	25	100	D
75			35 521 075	34,66	1,444	1	50	D
90			35 521 090	54,50	2,271	1	50	D
110			35 521 110	67,08	2,795	1	20	D

### 35 520



typ B



typ C

### PP příchytky

d mm	typ	m kg	objednáací kód	cena Kč	cena EUR	balení [ks]		sk
						MB	VB	
16	B	0,006	35 520 016	7,70	0,308	10	1 500	D
20	B	0,007	35 520 020	7,20	0,288	10	1 100	D
25	B	0,009	35 520 025	8,60	0,344	10	900	D
32	B	0,013	35 520 032	11,00	0,440	10	600	D
40	C	0,023	35 520 040	21,00	0,840	10	370	D
50	C	0,029	35 520 050	26,80	1,072	10	240	D
63	C	0,039	35 520 063	30,60	1,224	10	280	D
75	C	0,055	35 520 075	39,70	1,588	10	240	D
90	C	0,085	35 520 090	53,10	2,124	10	100	D
110	C	0,100	35 520 110	63,10	2,524	10	100	D

### 95 100



### objímka dvoušroubová pozink

velikost mm	PN bar	m kg	objednáací kód	cena Kč	cena EUR	balení [ks]		sk
						MB	VB	
12 - 16 M8			95 100 012 016	9,20	0,383		100	D
17 - 19 M8			95 100 017 019	9,90	0,413		100	D
20 - 23 M8			95 100 020 023	10,40	0,433		100	D
25 - 30 M8			95 100 025 030	11,40	0,475		100	D
31 - 38 M8			95 100 031 038	12,10	0,504		100	D
40 - 46 M8			95 100 040 046	13,20	0,550		100	D
48 - 53 M8			95 100 048 053	14,10	0,588		50	D
54 - 59 M8/M10			95 100 054 059	20,50	0,854		50	D
60 - 64 M8/M10			95 100 060 064	22,00	0,917		50	D
67 - 71 M8/M10			95 100 067 071	23,70	0,988		50	D
72 - 78 M8/M10			95 100 072 078	28,30	1,179		50	D
81 - 86 M8/M10			95 100 081 086	32,20	1,342		50	D
87 - 92 M8/M10			95 100 087 092	33,40	1,392		50	D
95 - 103 M8/M10			95 100 095 103	35,20	1,467		50	D
102 - 116 M8/M10			95 100 102 116	40,70	1,696		50	D
121 - 127 M8/M10			95 100 121 127	52,40	2,183		25	D
133 - 141 M8/M10			95 100 133 141	56,30	2,346		25	D
159 - 168 M8/M10			95 100 159 168	63,30	2,638		25	D
193 - 203 M8/M10			95 100 193 203	73,30	3,054		15	D
204 - 210 M8/M10			95 100 204 210	74,60	3,108		12	D
210 - 219 M8/M10			95 100 210 219	76,00	3,167		12	D

95 101

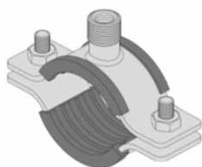

objímka dvoušroubová MASIV pozink

velikost mm	PN bar	m kg	objednáací kód	cena Kč	cena EUR	balení [ks]		sk
						MB	VB	
108 - 118		0,827	95 101 110	144,10	6,004		25	D
159 - 165		1,061	95 101 160	187,80	7,825		20	D
193 - 203		1,181	95 101 200	228,00	9,500		15	D
278 - 282			95 101 280	289,70	12,071			D
313 - 318			95 101 315	323,40	13,475		9	D
353 - 360			95 101 355	458,90	19,121			D

upínací hlava UNI M12, M16, G1/2" vnější

95 111



šroub kombi torx

velikost mm	PN bar	m kg	objednáací kód	cena Kč	cena EUR	balení [ks]		sk
						MB	VB	
M8 x 50			95 111 008 050	1,40	0,058		100	D
M8 x 60			95 111 008 060	1,80	0,075		100	D
M8 x 70			95 111 008 070	2,00	0,083		100	D
M8 x 80			95 111 008 080	2,30	0,096		100	D
M8 x 100			95 111 008 100	2,90	0,121		100	D
M8 x 120			95 111 008 120	3,40	0,142		100	D
M8 x 140			95 111 008 140	4,10	0,171		100	D
M8 x 160			95 111 008 160	5,00	0,208		100	D
M8 x 180			95 111 008 180	5,50	0,229		50	D
M10 x 80			95 111 010 080	3,50	0,146		100	D
M10 x 100			95 111 010 100	4,50	0,188		100	D
M10 x 120			95 111 010 120	5,90	0,246		50	D
M10 x 140			95 111 010 140	7,60	0,317		100	D
M12 x 140			95 111 012 140	9,30	0,388		100	D
M12 x 180			95 111 012 180	12,00	0,500		100	D

95 114



závitová tyč pozink

	PN bar	m kg	objednáací kód	cena Kč	cena EUR	balení [ks]		sk
						MB	VB	
M8/1m			95 114 008 100	29,40	1,225		50	D
M8/2m			95 114 008 200	58,80	2,450		25	D
M10/1m			95 114 010 100	44,90	1,871		25	D
M10/2m			95 114 010 200	89,80	3,742		25	D
M16/1m			95 114 016 100	124,10	5,171		10	D
M20/1m			95 114 020 100	203,10	8,463		5	D

95 112



spojovací matice

	PN bar	m kg	objednáací kód	cena Kč	cena EUR	balení [ks]		sk
						MB	VB	
M8x13x24 DIN6334			95 112 008	3,20	0,133		100	D
M10x17x30 DIN6334			95 112 010	6,90	0,288		50	D

95 120



hmoždinka nylonová

d mm	PN bar	m kg	objednáací kód	cena Kč	cena EUR	balení [ks]		sk
						MB	VB	
6			95 120 006	0,50	0,021		100	D
8			95 120 008	1,00	0,042		100	D
10			95 120 010	1,40	0,058		100	D
12			95 120 012	2,60	0,108		100	D
14			95 120 014	3,40	0,142		50	D

95 160



upevňovací deska pozink

d mm	PN bar	m kg	objednáací kód	cena Kč	cena EUR	balení [ks]		sk
						MB	VB	
80 x 30 M8			95 160 001	13,70	0,571		100	D
80 x 30 M10			95 160 002	14,90	0,621		100	D

95 151

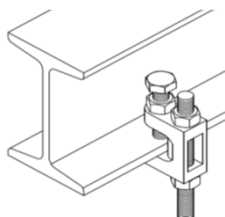

nosná svěrka pozink

	PN bar	m kg	objednáací kód	cena Kč	cena EUR	balení [ks]		sk
						MB	VB	
0 - 20mm M10			95 151 003	38,40	1,600			D
0 - 26mm M12			95 151 004	67,90	2,829			D

konzola pozink



d mm	PN bar	m kg	objednáací kód	cena Kč	cena EUR	balení [ks]		sk
						MB	VB	
27x18 x 200			95 160 101	90,20	3,758		20	D
27x18 x 300			95 160 102	100,10	4,171		20	D
28x30 x 200			95 160 111	114,20	4,758		10	D
28x30 x 300			95 160 112	126,10	5,254		10	D
28x30 x 440			95 160 113	152,00	6,333		10	D
28x30 x 500			95 160 114	160,60	6,692		10	D

Rovnoměrné zatížení  
Uniform load

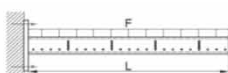

L (mm)	Konzola Cantilever arm		Konzola Cantilever arm		Konzola Cantilever arm	
	27/18 F (N)	28/30 F (N)	38/40 F (N)	ST 41/41 (2,5) F (N)	ST 41/62 (2,5) F (N)	
100	892	3465	6812	9172	18030	
150	595	2310	4542	6115	12020	
200	445	1730	3405	4585	9016	
250	305	1385	2725	3670	7210	
300	212	1155	2270	3055	6010	
350	155	990	1945	2620	5150	
400	118	810	1702	2294	4508	
450	94	640	1514	2038	4005	
500	75	520	1338	1830	3605	
550	62	430	1105	1512	3278	
600	52	360	930	1270	3005	
700	-	265	682	934	2575	
750	-	233	602	824	2340	
800	-	202	522	715	2105	
900	-	160	412	565	1662	
950	-	145	373	511	1503	
1000	-	130	335	458	1345	
1100	-	105	276	378	1110	
1200	-	90	232	318	935	
1300	-	-	198	270	795	
1400	-	-	170	232	685	
1500	-	-	-	202	598	

Zatížení na konci  
Load on the end

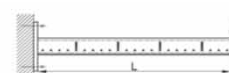

L (mm)	Konzola Cantilever arm		Konzola Cantilever arm		Konzola Cantilever arm	
	27/18 F (N)	28/30 F (N)	38/40 F (N)	ST 41/41 (2,5) F (N)	ST 41/62 (2,5) F (N)	
100	445	1732	3405	4585	9015	
150	298	1155	2270	3055	6010	
200	178	865	1702	2294	4505	
250	114	692	1362	1835	3605	
300	78	540	1135	1528	3005	
350	58	396	972	1310	2575	
400	45	305	784	1070	2254	
450	35	240	620	845	2004	
500	28	195	500	685	1802	
550	24	160	415	565	1638	
600	20	135	348	475	1402	
700	-	100	255	350	1030	
750	-	88	225	308	908	
800	-	76	195	268	788	
900	-	60	155	210	624	
950	-	54	140	190	564	
1000	-	49	125	172	505	
1100	-	40	102	142	418	
1200	-	34	86	118	350	
1300	-	-	74	102	298	
1400	-	-	64	88	258	
1500	-	-	-	75	225	

10 N = 1 kg

montážní nosník pozink



mm	PN bar	m kg	objednáací kód	cena Kč	cena EUR	balení [ks]		sk
						MB	VB	
38x40x2/6000			95 161 023	1 288,20	53,675			D

upevňovací sestava do C nosníku



d mm	PN bar	m kg	objednáací kód	cena Kč	cena EUR	balení [ks]		sk
						MB	VB	
27x18/28x30 M8x50			95 160 903	10,20	0,425		100	D

95 082



hadicová spona pozink šířka 9mm

d mm	PN bar	m kg	objednáací kód	cena Kč	cena EUR	balení [ks]		sk
						MB	VB	
8 - 12			95 082 008	4,50	0,188	50	1000	D
10 - 16			95 082 010	4,50	0,188	50	1000	D
12 - 20			95 082 012	4,80	0,200	50	1000	D
16 - 25			95 082 016	4,90	0,204	50	1000	D
20 - 32			95 082 020	5,40	0,225	50	1000	D
25 - 40			95 082 025	6,00	0,250	50	500	D
32 - 50			95 082 032	6,40	0,267	50	500	D
40 - 60			95 082 040	7,30	0,304	50	500	D
50 - 70			95 082 050	7,60	0,317	50	500	D

95 080



hadicová spona nerez (17240, DIN 1.4301, AISI304) šířka 9mm

d mm	PN bar	m kg	objednací kód	cena Kč	cena EUR	balení [ks]		sk
						MB	VB	
8 - 12			95 080 008	7,90	0,329	50	1000	D
10 - 16			95 080 010	7,90	0,329	50	1000	D
12 - 20			95 080 012	7,90	0,329	50	1000	D
16 - 25			95 080 016	8,40	0,350	50	1000	D
20 - 32			95 080 020	10,10	0,421	50	1000	D
25 - 40			95 080 025	10,50	0,438	50	500	D
32 - 50			95 080 032	11,20	0,467	50	500	D
40 - 60			95 080 040	12,30	0,513	50	500	D
50 - 70			95 080 050	12,90	0,538	50	500	D

95 130



stahovací pásek plastový černý UV odolný

d mm	PN bar	m kg	objednací kód	cena Kč	cena EUR	balení [ks]		sk
						MB	VB	
2,5 x 100			95 130 025 100	0,30	0,013	100		D
2,5 x 120			95 130 025 120	0,40	0,017	100		D
2,5 x 165			95 130 025 165	0,50	0,021	100		D
2,5 x 203			95 130 025 203	0,60	0,025	100		D
3,6 x 150			95 130 036 150	0,70	0,029	100		D
3,6 x 203			95 130 036 203	1,10	0,046	100		D
3,6 x 292			95 130 036 292	1,40	0,058	100		D
3,6 x 368			95 130 036 368	1,90	0,079	100		D
4,8 x 190			95 130 048 190	1,10	0,046	100		D
4,8 x 250			95 130 048 250	1,60	0,067	100		D
4,8 x 368			95 130 048 368	2,10	0,088	100		D
4,8 x 450			95 130 048 450	4,20	0,175	100		D

35 01x



izolace potrubí TUBEX Standart

d x e mm	PN bar	m kg	objednací kód	cena Kč	cena EUR	balení [ks]		sk
						MB	VB	
22 x 6			35 011 022	7,20	0,300		400	E
28 x 6			35 011 028	9,70	0,404		280	E
22 x 10			35 012 022	14,60	0,608		270	E
28 x 10			35 012 028	13,50	0,563		190	E
35 x 10			35 012 035	16,10	0,671		150	E

95 002



**šroub šestihránná hlava, částečný závit, pevnost 8.8, pozink DIN931**

	PN bar	m kg	objednáací kód	cena Kč	cena EUR	balení [ks]		sk
						MB	VB	
M16 x 80			95 002 016 080	20,30	0,846	25		E
M16 x 90			95 002 016 090	21,30	0,888	25		E
M16 x 100			95 002 016 100	13,00	0,542	25		E
M16 x 110			95 002 016 110	26,90	1,121	25		E
M16 x 120			95 002 016 120	15,30	0,638	25		E
M16 x 130			95 002 016 130	31,70	1,321	25		E
M16 x 140			95 002 016 140	39,40	1,642	25		E
M16 x 150			95 002 016 150	51,00	2,125	25		E
M16 x 160			95 002 016 160	40,70	1,696	25		E
M16 x 180			95 002 016 180	48,10	2,004	25		E
M20 x 80			95 002 020 080	44,20	1,842	25		E
M20 x 90			95 002 020 090	38,80	1,617	25		E
M20 x 100			95 002 020 100	30,40	1,267	25		E
M20 x 110			95 002 020 110	44,00	1,833	25		E
M20 x 120			95 002 020 120	45,80	1,908	25		E
M20 x 130			95 002 020 130	46,90	1,954	25		E
M20 x 140			95 002 020 140	42,90	1,788	25		E
M20 x 150			95 002 020 150	45,60	1,900	10		E
M20 x 160			95 002 020 160	58,20	2,425	10		E
M20 x 180			95 002 020 180	60,00	2,500	10		E
M20 x 200			95 002 020 200	63,60	2,650	10		E

95 060



**matice šestihránná, pevnost 8, pozink DIN934**

	PN bar	m kg	objednáací kód	cena Kč	cena EUR	balení [ks]		sk
						MB	VB	
M16			95 060 016	3,10	0,129	180		E
M20			95 060 020	5,80	0,242	90		E

95 070



**podložka, pozink DIN125A**

	PN bar	m kg	objednáací kód	cena Kč	cena EUR	balení [ks]		sk
						MB	VB	
d17 pro M16			95 070 016	1,80	0,075	300		E
d21 pro M20			95 070 020	2,40	0,100	150		E

95 140

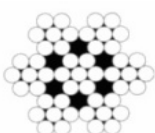

**lanko, nerez AISI316 DIN3055**

d mm	PN bar	m kg/m	objednáací kód	cena Kč	cena EUR	balení [m]		sk
						MB	VB	
d3 7x7		0,036	95 140 030	20,40	0,850		500	E

95 141



**lanová svorka, nerez AISI316 DIN741**

d mm	PN bar	m kg	objednáací kód	cena Kč	cena EUR	balení [ks]		sk
						MB	VB	
3			95 141 030	23,40	0,975			E

07 003



**manometr**

	PN bar	m kg	objednáací kód	cena Kč	cena EUR	balení [ks]		sk
						MB	VB	
d63 6bar spodní vývod 1/4"	6		07 003 001	106,30	4,429			Z
d63 10bar spodní vývod 1/4"	10		07 003 002	132,00	5,500			Z
d63 6bar spodní vývod 1/4" glycerinový	6		07 003 011	288,00	12,000			Z
d63 10bar spodní vývod 1/4" glycerinový	10		07 003 012	260,00	10,833			Z

### Griffon UNI-100 PVC-U lepidlo



Velikost		objednací kód	cena Kč	cena EUR	balení [ks]		sk
					MB	VB	
5l bez štětce		90 010 027	2 293,00	91,720		1	F
1l se štětcem		90 010 025	508,00	20,320		8	F
0,5l se štětcem		90 010 023	308,00	12,320		12	F
0,25l se štětcem		90 010 022	182,00	7,280		24	F
0,125l tuba		90 010 021	171,00	6,840		30	F

Rychlé lepidlo na PVC-U, schváleno pro pitnou vodu, vhodné do průměru 315mm PN16

DOBA TVRDNUTÍ

Ø	16 - 63 mm		75 - 110 mm		125 - 315 mm	
	10 barů	16 barů	10 barů	16 barů	10 barů	16 barů
5°C - 10°C	4 hod.	8 hod.	8 hod.	16 hod.	16 hod.	32 hod.
>10°C	2 hod.	4 hod.	4 hod.	8 hod.	8 hod.	16 hod.

### Griffon čistič PVC-U, PVC-C a ABS



Velikost		objednací kód	cena Kč	cena EUR	balení [ks]		sk
					MB	VB	
5l		90 010 044	1 588,00	63,520		1	F
1l		90 010 043	393,00	15,720		6	F
0,5l		90 010 042	241,00	9,640		12	F
0,25l		90 010 041	178,00	7,120		12	F
0,125l		90 010 040	119,00	4,760		20	F

### Griffon UNI-100 GT PVC-U lepidlo pro velké průměry



Velikost		objednací kód	cena Kč	cena EUR	balení [ks]		sk
					MB	VB	
5l bez štětce		90 010 032	2 252,00	90,080		1	F
1l bez štětce		90 010 031	---	---		8	-
1l se štětcem		90 010 030	507,00	20,280		8	F
0,5l se štětcem		90 010 029	---	---		12	-

Lepidlo na PVC-U zejména pro velké průměry a při vyšších teplotách, má delší čas zpracování, pro průměry do 800mm PN16

DOBA TVRDNUTÍ

Ø	16 – 63 mm		75 – 110 mm		125 – 315 mm		400 – 800 mm	
	10 BAR	16 BAR	10 BAR	16 BAR	10 BAR	16 BAR	10 BAR	16 BAR
5°C - 10°C	8 hours	16 hours	16 hours	32 hours	32 hours	64 hours	64 hours	128 hours
10°C - 25°C	4 hours	8 hours	8 hours	16 hours	16 hours	32 hours	32 hours	64 hours
>25°C	2 hours	4 hours	4 hours	8 hours	8 hours	16 hours	16 hours	32 hours

### Griffon WDF-0,5 PVC-U lepidlo rychleschnoucí lepidlo pro flexihadice



Velikost		objednací kód	cena Kč	cena EUR	balení [ks]		sk
					MB	VB	
0,5l se štětcem		90 010 034	336,00	13,440		12	F

Velmi rychlé modré lepidlo na PVC pro spojování flexi hadic, trubek a tvarovek do průměru 160mm PN16

DOBA TVRDNUTÍ

Ø	16 - 50 mm			63 - 110 mm			125 - 160 mm		
	5 barů	10 barů	16 barů	5 barů	10 barů	16 barů	5 barů	10 barů	16 barů
5°C - 15°C	30 min.	1 hod.	4 hod.	1 hod.	2 hod.	8 hod.	4 hod.	16 hod.	32 hod.
>15°C	15 min.	30 min.	2 hod.	30 min.	1 hod.	4 hod.	2 hod.	8 hod.	16 hod.

Pružné hadice 24 hod.

### Čistič na PE, PP, PB a PVDF



Velikost	objednací kód	cena Kč	cena EUR	balení [ks]		sk
				MB	VB	
Tangit KS 1l	90 010 009	367,00	15,292		6	F
Griffon čistič 1l	90 010 050	369,00	14,760		12	F
Griffon ubrousky 100ks v dóze 1)	90 010 051	440,00	17,600		6	F

1) ubrousky jsou navlhčeny čističem

### TANGIT PVC-U lepidlo



Velikost		objednáací kód	cena Kč	cena EUR	balení [ks]		sk
					MB	VB	
1kg plechovka se štětcem		90 010 004	632,50	26,354		12	F
500g plechovka se štětcem		90 010 003	424,50	17,688		12	F
250g plechovka se štětcem		90 010 002	235,00	9,792		12	F
125g tuba		90 010 001	129,00	5,375		12	F

### TANGIT čistič PVC-U, PVC-C a ABS



Velikost		objednáací kód	cena Kč	cena EUR	balení [ks]		sk
					MB	VB	
1l plechovka		90 010 006	382,00	15,917		12	F
125ml plechovka		90 010 005	142,00	5,917		20	F

### Dytex speciální chemicky odolné lepidlo PVC-U a PVC-C



Velikost		objednáací kód	cena Kč	cena EUR	balení [ks]		sk
					MB	VB	
Dytex lepidlo 650g		90 010 015	2 131,00	88,792			H
Dytex čistič 0,5l		90 010 016	1 931,00	80,458			H

### TANGIT ABS lepidlo



Velikost		objednáací kód	cena Kč	cena EUR	balení [ks]		sk
					MB	VB	
TANGIT lepidlo 650g		90 010 014	899,00	37,458		6	H

### hadřík 23 x 41cm savý nežmolující hadřík pro použití s čističem PVC-U nebo PE



Velikost		objednáací kód	cena Kč	cena EUR	balení [ks]		sk
					MB	VB	
box 100ks		90 010 052	536,00	21,440		6	F

### TANGIT Uni-lock vlákno pro závitové spoje



Velikost		objednáací kód	cena Kč	cena EUR	balení [ks]		sk
					MB	VB	
20m		90 010 013	90,00	3,750		20	H
80m		90 010 010	233,00	9,708		20	H

### Griffon FLON-100 teflonové vlákno pro závitové spoje



Velikost		objednáací kód	cena Kč	cena EUR	balení [ks]		sk
					MB	VB	
175m		90 010 060	488,00	19,520		12	F

### Teflonová páska pro závitové spoje



Velikost		objednáací kód	cena Kč	cena EUR	balení [ks]		sk
					MB	VB	
12mm x 0,076mm x 12m		90 010 061	13,90	0,556		250	F
19mm x 0,2mm x 12m		90 010 063	136,00	5,440		70	F

### Griffon mazivo ve spreji



Velikost		objednáací kód	cena Kč	cena EUR	balení [ks]		sk
					MB	VB	
mazivo 400ml spray		90 010 071	154,00	6,160		12	Z

Mazivo pro potrubní systémy s nasunovacími spoji s pryžovým těsněním. Pro odpadní, kanalizační a drenážní systémy. Vhodné pro PVC-U, ABS, PE, PP, sklolaminát, beton a litinu.

### Griffon silikonový olej ve spreji



Velikost		objednáací kód	cena Kč	cena EUR	balení [ks]		sk
					MB	VB	
silikon 300ml spray		90 010 073	142,00	5,680		12	Z





### Griffon PTFE spray

Velikost		objednáací kód	cena Kč	cena EUR	balení [ks]		sk
					MB	VB	
PTFE 300ml spray		90 010 072	208,00	8,320		12	Z



### Griffon AQUA MAX tmel

Velikost		objednáací kód	cena Kč	cena EUR	balení [ks]		sk
					MB	VB	
AQUA MAX 425g		90 010 080	251,00	10,040		12	Z

Bílý lepicí a těsnící tmel bez obsahu rozpouštědel na bázi SMP-polymerů s velmi vysokou elasticitou. Odolný chlorované a mořské vodě, odolný UV záření, teplotní odolnost -40°C až +100°C

### CERESIT montážní pěna



Typ		objednáací kód	cena Kč	cena EUR	balení [ks]		sk
					MB	VB	
Ceresit TS61 trubičková	500ml	90 012 001	162,50	6,771		12	N
Ceresit TS61 trubičková	750ml	90 012 002	201,00	8,375		12	N
Ceresit TS51 trubičková zimní	750ml	90 012 004	209,00	8,708		12	N
Ceresit TS62 pistolová	750ml	90 012 006	212,00	8,833		12	N
Ceresit TS52 pistolová zimní	750ml	90 012 007	223,50	9,313		12	N
Ceresit TS63 pistolová nízkoexp.	750ml	90 012 008	225,00	9,375		12	N
Ceresit TS100 čistič PU pěny	500ml	90 012 009	155,50	6,479		12	N
PROFI pistole na PU SDT15		90 012 011	726,00	30,250		1	N

### značkovací spray



Typ		objednáací kód	cena Kč	cena EUR	balení [ks]		sk
					MB	VB	
oranžový	500ml	07 100 001	158,00	6,583		6	N
žlutý	500ml	07 100 002	158,00	6,583		6	N
červený	500ml	07 100 005	158,00	6,583		6	N
modrý	500ml	07 100 004	158,00	6,583		6	N

### výstražná folie LDPE 150mikronů šířka 30cm návin 250m

Typ		objednáací kód	cena Kč/m	cena EUR/m	balení [ks]		sk
					MB	VB	
modrá		35 100 001	3,60	0,150			Z
žlutá		35 100 002	3,60	0,150			Z
červená		35 100 003	3,60	0,150			Z

### odřezávač plastových trubek Rothenberger



provedení	objednací kód	cena Kč	cena EUR	balení [ks]		sk
				MB	VB	
velikost I d16 - 67	25 002 001	3 790,00	157,917			N
náhradní řezací kolečka (3ks) 7,0mm	25 002 011	1 185,00	49,375			N
velikost II d50 - 125	25 002 002	5 400,00	225,000			N
náhradní řezací kolečka (3ks) 13,0mm	25 002 012	1 645,00	68,542			N
velikost III d110 - 168	25 002 003	6 800,00	283,333			N
náhradní řezací kolečka (2ks) 16mm	25 002 014	1 415,00	58,958			N

### úkosovač Rothenberger



velikost	objednací kód	cena Kč	cena EUR	balení [ks]		sk
				MB	VB	
velikost I d16 - 110	25 003 001	7 755,00	323,125			N
velikost II d32 - 160	25 003 002	8 715,00	363,125			N

Pro srážení vnějších hran trubky pod úhlem 15° na plastových trubkách.

### kurťový hasák Rothenberger



velikost	objednací kód	cena Kč	cena EUR	balení [ks]		sk
				MB	VB	
do průměru 90 mm, L=300mm	25 001 001	2 115,00	88,125			N
náhradní pásek	25 001 011	885,00	36,875			N
do průměru 220 mm, L=300mm	25 001 002	2 540,00	105,833			N
náhradní pásek	25 001 012	995,00	41,458			N

### klíč na svěrné tvarovky



velikost	objednací kód	cena Kč	cena EUR	balení [ks]		sk
				MB	VB	
kovový d40 - d63	25 006 003	649,00	25,960			N
kovový d75 - d110	25 006 004	908,80	36,352			N
plastový d40 - d63	25 006 005	91,00	3,792			E

### nůžky na plastové trubky Rothenberger



provedení	objednací kód	cena Kč	cena EUR	balení [ks]		sk
				MB	VB	
ROCUT 32 TC do 32mm	25 004 001	1 690,00	70,417			N
náhradní nerezový nůž	25 004 011	905,00	37,708			N
ROCUT Profesional 42 TC do 42mm	25 004 003	2 080,00	86,667			N
náhradní nerezový nůž	25 004 013	1 505,00	62,708			N
ROCUT Profesional 50 TC do 50mm	25 004 004	2 500,00	104,167			N
náhradní nerezový nůž	25 004 014	1 685,00	70,208			N
ROCUT Profesional 63 TC do 63mm	25 004 005	3 300,00	137,500			N
ROCUT Profesional 75 TC do 75mm	25 004 006	6 000,00	250,000			N
náhradní nerezový nůž	25 004 016	3 355,00	139,792			N

## Nářadí

### Svářečky na tupo Ritmo Basic



provedení	objednací kód	cena Kč	cena EUR	balení [ks]		sk
				MB	VB	
Basic 160 (40 - 160)	25 100 001	159 979,10	6 399,16			Z
Basic 200 (63 - 200)	25 100 002	179 780,70	7 191,23			Z
Basic 250 (75 - 250)	25 100 003	206 215,10	8 592,30			Z
Basic 315 (90 - 315)	25 100 004	253 089,20	10 545,38			Z
Basic 355 (125 - 355)	25 100 005	0,00	0,00			Z

cena včetně kompletní sady čelistí, možnost připojení záznamového zařízení

### Svářečky na tupo Ritmo Basic easy life



provedení	objednací kód	cena Kč	cena EUR	balení [ks]		sk
				MB	VB	
Basic easy life 160 (40 - 160)	25 100 011	0,00	0,00			Z
Basic easy life 200 (63 - 200)	25 100 012	0,00	0,00			Z
Basic easy life 250 (75 - 250)	25 100 013	0,00	0,00			Z
Basic easy life 315 (90 - 315)	25 100 014	0,00	0,00			Z
Basic easy life 355 (125 - 355)	25 100 015	0,00	0,00			Z

cena včetně kompletní sady čelistí, paměť na 400 svárů

### Svářečky na tupo Ritmo Delta



provedení	objednací kód	cena Kč	cena EUR	balení [ks]		sk
				MB	VB	
Delta 500 (200 - 500) bez čelistí	25 100 025	0,00	0,00			Z
kompletní sada čelistí d200 - d450	25 100 027	0,00	0,00			Z
Delta 630 (280 - 630) bez čelistí	25 100 028	544 017,80	22 667,41			Z
kompletní sada čelistí d280 - d560	25 100 029	231 835,50	9 659,81			Z
Delta 800 (500 - 800)		na dotaz				
Delta 1000 (630 - 1000)		na dotaz				
Delta 1200 (710 - 1200)		na dotaz				
Delta 1600 (800 - 1600)		na dotaz				

cena včetně kompletní sady čelistí, možnost připojení záznamového zařízení

Dále v nabídce CNC svářečky, svářečky pro svařování pod úhlem do průměru 1600mm

### záznamové zařízení Inspector



provedení	objednací kód	cena Kč	cena EUR	balení [ks]		sk
				MB	VB	
Inspector	25 100 030	0,00	0,00			Z

### Svářečky pro elektrotvarovky Ritmo

provedení	objednací kód	cena Kč	cena EUR	balení [ks]		sk
				MB	VB	
Elektra light	25 101 001	0,00	0,00			Z
Elektra 315	25 101 005	61 798,13	2 471,93			Z
Elektra 500	25 101 006	0,00	0,00			Z
Elektra 1000	25 101 007	0,00	0,00			Z
software Ritmo transfer	25 101 004	0,00	0,00			Z
Elektra S	25 101 011	44 058,80	1 762,35			Z
Elektra M	25 101 012	59 138,40	2 365,54			Z
Elektra XL	25 101 014	78 657,20	3 146,29			Z



### Svářečky pro elektrotvarovky IPlast

provedení	objednací kód	cena Kč	cena EUR	balení [ks]		sk
				MB	VB	
IPlast 30	25 101 021	30 925,10	1 237,00			Z
IPLast 60	25 101 022	43 659,00	1 746,36			Z
IPlast 105	25 101 023	60 031,10	2 401,24			Z



### Škrabky

provedení	objednací kód	cena Kč	cena EUR	balení [ks]		sk
				MB	VB	
ruční škrabka Ritmo	25 102 030	448,00	17,92			N
rotační škrabka OPPT125 d25-d125	25 102 041	26 540,00	1 105,83			N
rotační škrabka OPPT315 d75-d315	25 102 042	29 538,00	1 230,75			N
rotační škrabka PS180 d75-d200	25 102 031	762,00	31,75			N
rotační škrabka PS400 d140-d400	25 102 032	13 262,00	530,48			Z
rotační škrabka RTC160 d50-d160	25 102 033	23 462,00	938,48			Z
rotační škrabka RTC315 d75-d315	25 102 034	33 663,00	1 346,52			Z
rotační škrabka RTC710 d355-d710	25 102 035	42 609,00	1 704,36			Z



PS180



PS400



RCT315



RCT710



OPPT

## Půjčovna

---

Možnost zapůjčení svářečky na elektrotvarovky **ELEKTRA 315** nebo **IPlast 60**

- půjčovné 600 Kč/den

- při nákupu elektrotvarovek možnost zapůjčení zdarma



# SOLÁRNÍ ABSORBÉRY

# AKYSUN®

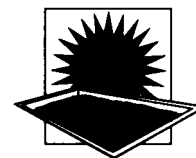

**...snadný a levný ohřev vody ve vašem bazénu**

## Popis

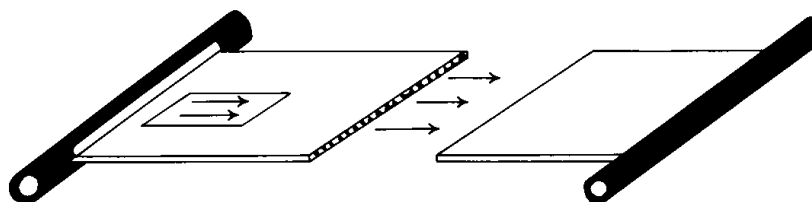

Solární absorbér **AKYSUN** je vyroben z polypropylenu, který je stabilizovaný proti UV záření. Základem je speciální dutinková deska, ve které proudí voda a ohřívá se působením slunečního záření. Na obou koncích desky je navařena polypropylenová trubka o průměru d50.

## Technické parametry:

Typ	SUN2012050	SUN2412050	SUN3012050	SUN4012050
Šířka [m]	1,2	1,2	1,2	1,2
Délka [m]	2	2,4	3	4
Plocha [m <sup>2</sup> ]	2,4	2,88	3,6	4,8
Vnější průměr trubky [mm]	50	50	50	50
Vnitřní průměr trubky [mm]	41	41	41	41
Hmotnost v prázdném stavu [kg]	6,6	7,6	9,0	11,4
Hmotnost absorbéru plného vody [kg]	16,4	18,8	22,5	28,6
Měrná hmotnost PP komůrkové desky [kg/m <sup>2</sup> ]	2	2	2	2
Doporučený průtok [l/s]	0,167	0,2	0,25	0,333
Maximální počet kolektorů v baterii vedle sebe pro sklon 10° a více [ks]	10	10	10	8
Maximální počet kolektorů v baterii vedle sebe pro sklon 0° [ks]	6	6	6	5
Tlaková ztráta jednoho absorberu při doporučeném průtoku [cm H <sub>2</sub> O]	1,9	3,1	4,3	7,9

Doporučený maximální provozní tlak 1bar

## Princip a tepelný výkon

Na Zemi dopadá sluneční záření o výkonu 1 373 W/m<sup>2</sup>, měřeno před vstupem do atmosféry. Průchodem atmosférou dojde ke snížení výkonu v závislosti na zeměpisné šířce a ročním období. V podmínkách ČR je výkon dopadajícího slunečního záření 1 000 – 1 050 W/m<sup>2</sup> v letním poledni a 300 W/m<sup>2</sup> v zimním poledni. V období duben až září se může teplo zachycené absorberem a předané protékající vodě pohybovat v rozmezí 3 – 5 kWh/m<sup>2</sup> za den, při jasném teplém dni. Výkon solárního absorberu je závislý na teplotě okolního vzduchu. Je-li teplota povrchu absorberu vyšší než teplota okolního vzduchu, dochází k ochlazení absorberu okolním vzduchem a tím k poklesu jeho účinnosti. Závislost účinnosti absorberu na teplotě okolního vzduchu znázorňuje následující graf.

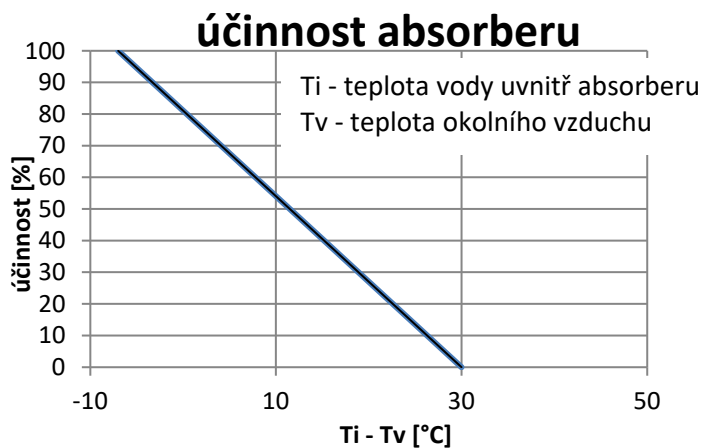

### Schema připojení k bazénu

EPDM spojka  
2 x hadicová spona  
PVC-U koleno  
PVC-U přechod  
automatický odvzdušňovací ventil

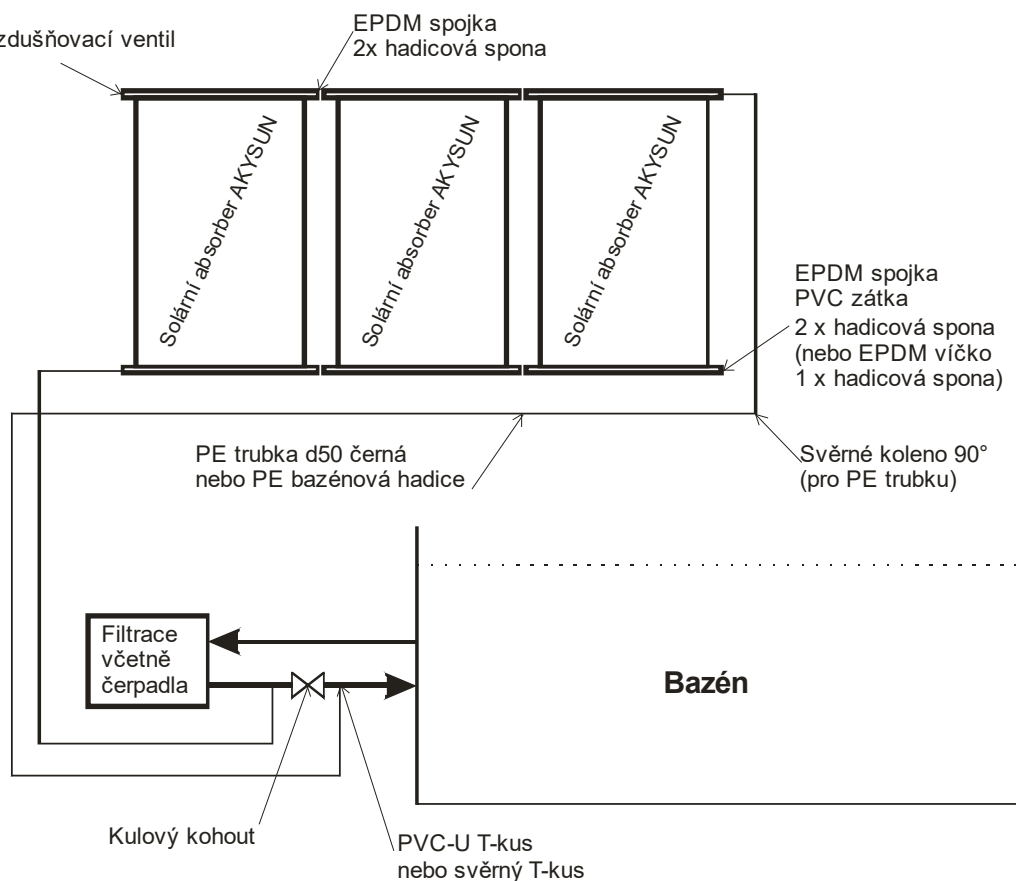

### Doporučená plocha absorberů

podle regionu a expozice vodní plochy (zastřešená či nezastřešená vodní plocha)  
doporučujeme cca **60 %** plochy povrchu bazénu (pro hloubku bazénu 1,2 m).

### Umístění absorberů:

**Orientace** - optimální nasměrování je směrem na jih. Mírné vychýlení je výhodnější směrem na západ než na východ.

**Naklonění** - optimální sklon, při kterém články dosahují maximálního výkonu, je kolem 30° - 45°. Minimální sklon 0° (lze položit na rovnou plochu).

**Umístění** - je důležité vyhnout se stínům i místům s proměnlivým slunečním svitem např. okolí domů, stromů. V případě paralelní instalace článků nesmí stínit jeden článek druhému.

**Upevnění** - při výběru místa je třeba zohlednit nebezpečí poškození absorberů větrem. Montáž se provádí pomocí nylonových kurtů na střešní krytinu, rámové držáky, piloty z betonu či bednění ze dřeva, umožňující umístění na vyvýšené místo. Možné je i položení na zem bez podpory.

### Důležité rady při instalaci

- průtok vody přes absorbery je třeba zajistit jen v době, kdy je voda v absorberech ohřívána. Při průtoku vody přes absorbery v noci při teplotě vzduchu nižší než je teplota vody v bazénu by byla voda naopak ochlazována.
- pro přívodní potrubní doporučujeme použít PE trubky, lze použít i PVC trubky nebo PP trubky. Černé PE trubky mají delší životnost jsou-li vystaveny slunečnímu záření než běžné PVC nebo PP trubky.
- doporučený průtok je 250 l/hod /m<sup>2</sup> článku
- napojení řady absorberů - používá se diagonálního větvení, viz příklady zapojení dále
- na každou řadu absorberů se umístí vypouštěcí ventil na nejnižší místo
- dimenze potrubí: vychází z celkového počtu absorberů a je třeba ji určit podle průtoku vody, viz doporučené průtoky. Pro instalace nepřekračující celkovým počtem kusů maximální doporučený počet kusů v jedné baterii je obvykle dostačující přívodní potrubí d50
- pro dimenzi čerpadla jsou určující výška umístění článků a tlakové ztráty v systému (potrubní rozvody, filtr a škrtecí nebo třicestný kohout)
- V případě, že instalujete panely na kovovou podpůrnou konstrukci a panely na zimu nedemontujete, zabraňte styku panelu s kovovou konstrukcí tepelně izolační podložkou, postačí např. pásy EPDM nebo jiného materiálu. V zimě dochází k vypařování a kondenzaci drobných zbytků vody v panelu. Drobné kapičky vody pak mohou v místech styku panelu s kovem v dutinkách namrznat, až dojde k zaplnění celého profilu dutinky ledem a poté k poškození panelu. Tento problém se vyskytuje zejména u střech s malým spádem.

### Zazimování

Voda v panelu nesmí zamrznout. Zamrznutí vody v panelu způsobí poškození dutinkové desky. Na škody způsobené zamrznutím vody v panelu se nevztahuje záruka.

Panely nainstalované tak, aby z nich voda mohla spolehlivě odtékat, zejména panely na šikmých střeších s velkým sklonem instalované tak, aby dutinky desky byly ve spádu střechy a spodní trubka baterie panelů byla v mírném spádu, stačí na zimu vypustit.

Panely nainstalované tak, že z nich voda nemůže spolehlivě vytéct, zejména panely nainstalované na plocho nebo na střeších s malým spádem nebo i panely nainstalované na střeše s velkým spádem, ale otočené tak, že ve směru spádu střechy jsou trubky panelu a ne dutinky desky je nutné na zimu dokonale vyfoukat stlačeným vzduchem nebo panely demontovat.

### Grafy tlakových ztrát baterií absorberů

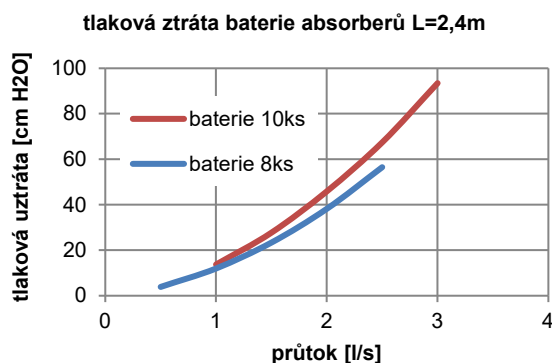
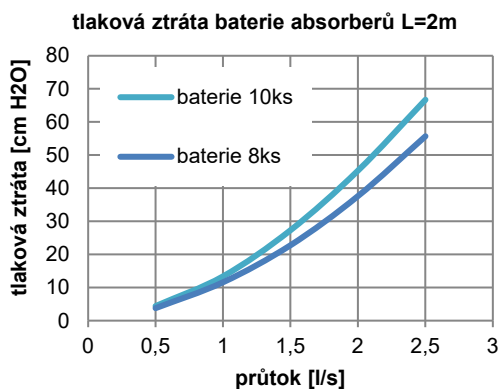



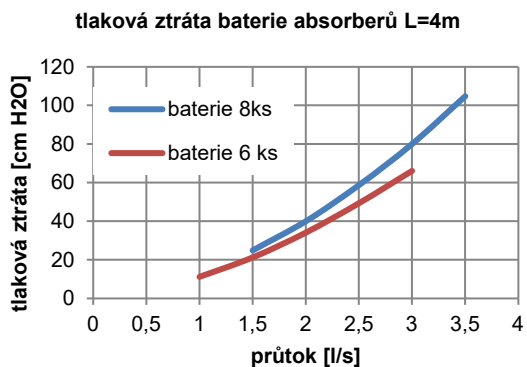
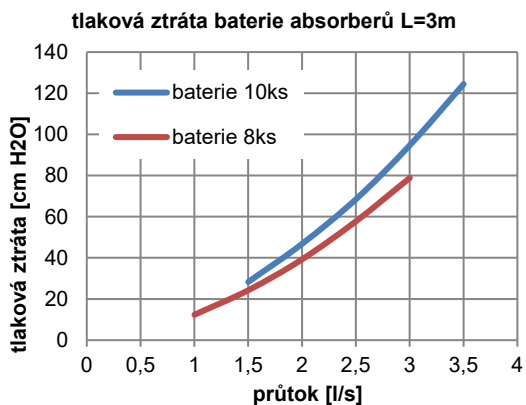

**Schema zapojení baterií solárních absorberů** (1 baterie = max. 8 -10 absorberů dle délky a sklonu)

Špatné zapojení baterií absorberů

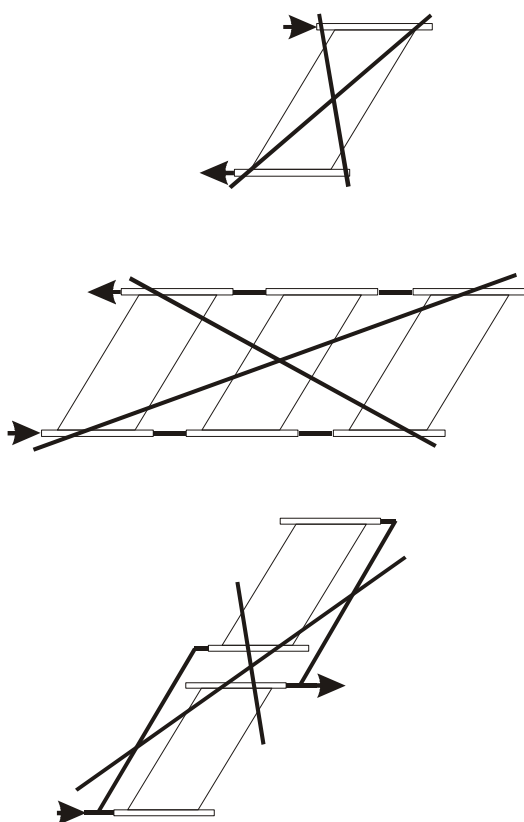

Správné zapojení baterií absorberů

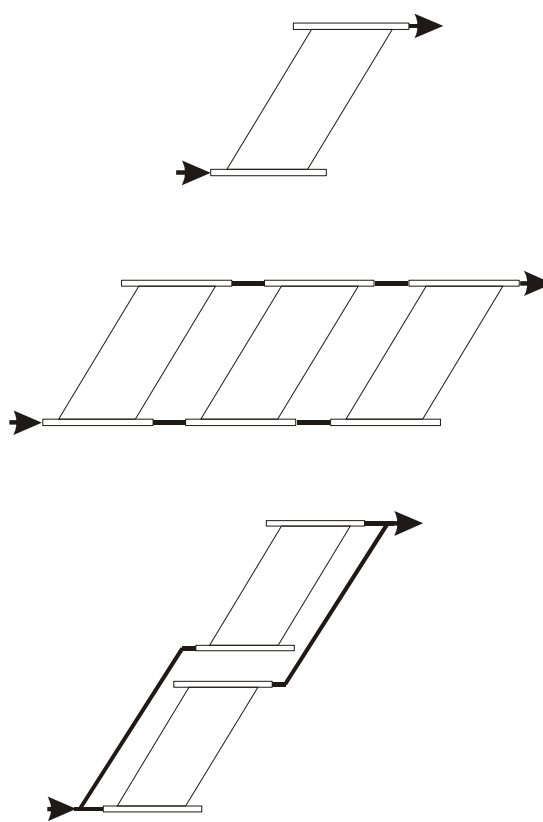

**Výpočet doporučené plochy a počtu solárních absorberů na Váš bazén**

V tabulce vycházíme ze standardní hloubky domácího bazénu 1,2 m. V případě, že je Váš bazén hlubší, vycházejte při určení plochy absorberů z celkového objemu vody.

Rozměr bazénu ( m x m x m )	Plocha vody m <sup>2</sup>	Objem vody m <sup>3</sup>	Doporučená plocha absorberů v m <sup>2</sup>	Doporučený průtok vody
8 x 4 x 1,2	32	38,4	19	4,8 m <sup>3</sup> /hod
9 x 4 x 1,2	36	43,2	22	5,5 m <sup>3</sup> /hod
10 x 5 x 1,2	50	60	30	7,5 m <sup>3</sup> /hod
11 x 5 x 1,2	55	66	33	8,3 m <sup>3</sup> /hod
12 x 6 x 1,2	72	86,4	43	10,8 m <sup>3</sup> /hod
14 x 6,5 x 1,2	91	109,2	55	13,8 m <sup>3</sup> /hod

## Ceník absorberů AKYSUN vč. příslušenství pro instalaci

Kód	Profil	Popis	MJ	Cena / MJ
SUN2012050		Solární absorber AKYSUN 2 kg/m <sup>2</sup> 1,2 x 2 m	ks	4 650,-
SUN2412050		Solární absorber AKYSUN 2 kg/m <sup>2</sup> 1,2 x 2,4 m	ks	5 150,-
SUN3012050		Solární absorber AKYSUN 2 kg/m <sup>2</sup> 1,2 x 3 m	ks	5 900,-
SUNGS02		EPDM spojka černá DN50 x d60 L=10cm	ks	59,80
SUN GK 02		EPDM víčko d50	ks	87,50
95 080 050		Hadicová spona 50 - 70 mm celonerezová	ks	12,90
SUNK50		Popruh pro montáž článku AKYSUN Materiál: PP, odstín černý	50 m	650,-
14 390 001		Ms automatický odvzdušňovací ventil 1/2"	ks	230,90
SUNKK01		Sestava škrtků kulový kohout PVC-U pro napojení do okruhu filtru 32/38 odbočení k solárním panelům 32/38	ks	357,20
32 PGI 051		PVC-U hadicový trn na lepení d50/40 x 32/38	ks	66,90

Celý sortiment absorberů a kompletní příslušenství pro montáž jsou na skladě nebo dostupné v krátkých dodacích lhůtách. Uvedené ceny jsou bez DPH (21%). Jiné formáty článků nebo doplňky pro montáž na objednávku.

### Sady solárních absorberů

Každá sada obsahuje instalační příslušenství pro instalaci v jedné řadě.

kód	množství [ks]							cena Kč	sk
	panel	EPDM spojka	EPDM zátky	nerezová spona	PVC-U koleno	PVC-U přechod	odvzdušňovací ventil		
panel 2 x 1,2 m									
SUN S20 001	1	3	1	7	1	1	1	5 318	D
SUN S20 002	2	5	1	11	1	1	1	10 135	D
SUN S20 003	3	7	1	15	1	1	1	14 950	D
panel 3 x 1,2 m									
SUN S30 001	1	3	1	7	1	1	1	6 570	D
SUN S30 002	2	5	1	11	1	1	1	12 635	D
SUN S30 003	3	7	1	15	1	1	1	18 700	D

# Kontakty

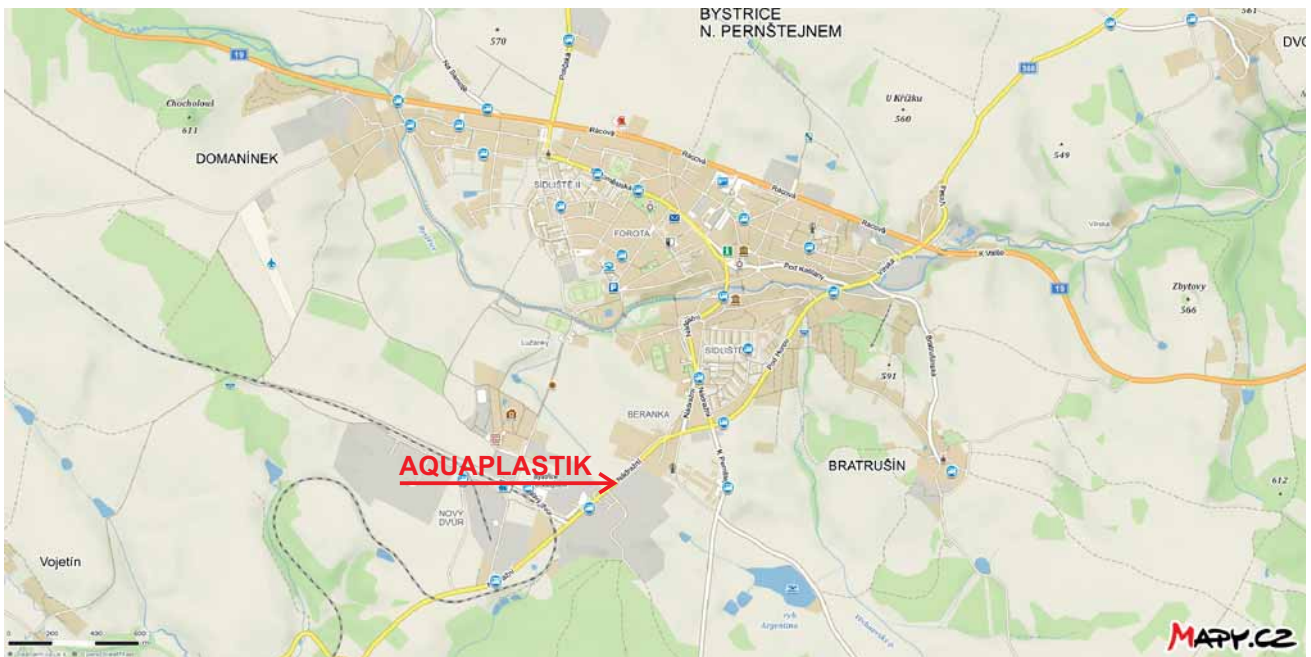
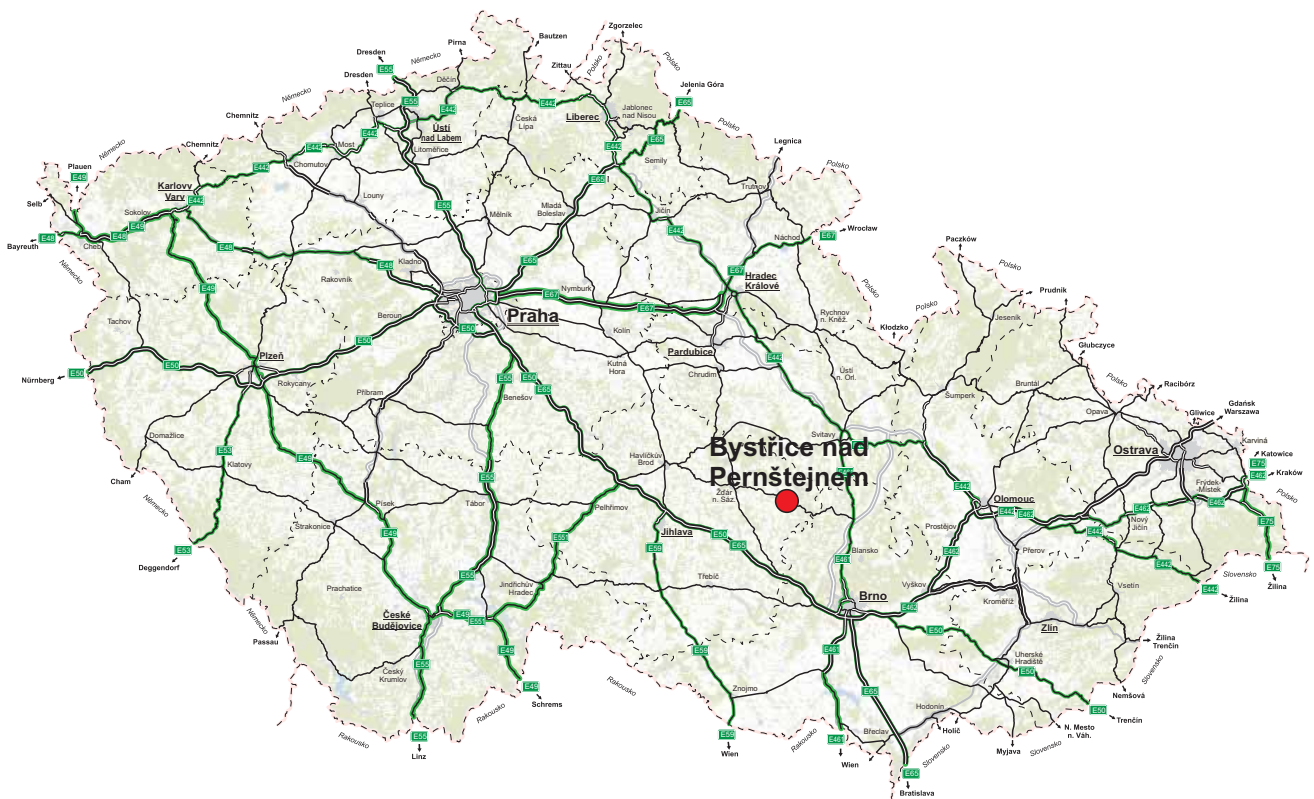

**sídlo firmy:**  
AQUAPLASTIK MORAVA s.r.o.  
Nádražní 663  
593 01 Bystrice nad Pernštejnem  
IČ: 26892243  
DIČ: CZ26892243

**provozovna:**  
AQUAPLASTIK MORAVA s.r.o.  
Nádražní 1401  
593 01 Bystrice nad Pernštejnem  
tel.: 566 550 281  
e-mail: info@aquaplastik.cz